

# Quick®

**High Quality Nautical Equipment**

## **KTB4 TEMPERATURE BOX 4CH SENSOR INTERFACE**

### **KTB4**

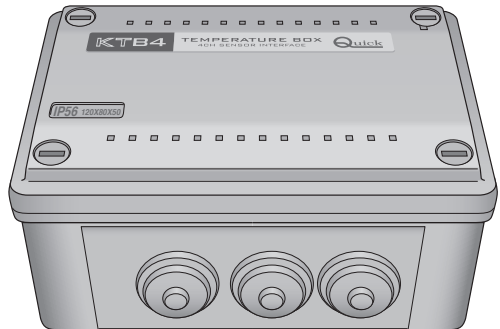

- IT** Manuale d'uso
- GB** User's Manual
- FR** Manuel de l'utilisateur
- DE** Benutzerhandbuch
- ES** Manual del usuario

**INTERFACCIA KTB4**

**INTERFACE KTB4**

**INTERFACE KTB4**

**SCHNITTSTELLE KTB4**

**INTERCARA KTB4**





## INDICE

Pag. 4	Caratteristiche - Installazione: installazione dell'interfaccia
Pag. 5	Installazione: collegamento elettrico
Pag. 6	Installazione: schema di collegamento
Pag. 7	Installazione: installazione del sensore di temperatura KTBS
Pag. 8	Installazione: attivazione dei terminatori
Pag. 9	Installazione: configurazione dell'interfaccia
Pag. 10	Funzionamento: grafici di compensazione di carica
Pag. 11	Funzionamento: pannello di controllo - Dati tecnici



## INDEX

Pag. 12	Characteristics - Installation: interface installation
Pag. 13	Installation: electric connections
Pag. 14	Installation: connection diagram
Pag. 15	Installation: installation of the ktbs temperature sensor
Pag. 16	Installation: activating the terminators
Pag. 17	Installation: interface configuration
Pag. 18	Operating: charge compensation graphs
Pag. 19	Operating: control panel - Technical data



## SOMMAIRE

Pag. 20	Caractéristiques - Installation: Installation de l'interface
Pag. 21	Installation: branchement électrique
Pag. 22	Installation: schéma de connexion
Pag. 23	Installation: Installation du capteur de température KTBS
Pag. 24	Installation: activation des terminaux
Pag. 25	Installation: configuration de l'interface
Pag. 26	Fonctionnement: graphiques de compensation de chargement
Pag. 27	Fonctionnement: tableau de contrôle - Caractéristiques techniques



## INHALTSANGABE

Seite 28	Eigenschaften - Installation: Installation der Schnittstelle
Seite 29	Installation: Stromanschluss
Seite 30	Installation: Anschlussplan
Seite 31	Installation: Installation des Temperatursensors KTBS
Seite 32	Installation: Aktivierung der terminatoren
Seite 33	Installation: configuration der Schnittstelle
Seite 34	Betrieb: graphiken Ladungsausgleich
Seite 35	Betrieb: Bedienungs Display - Technische Daten



## INDICE

Pág. 36	Características - Instalación: Instalación dell'intercara
Pág. 37	Instalación: conexión eléctrica
Pág. 38	Instalación: esquema de conexión
Pág. 39	Instalación: instalación del sensore de temperatura KTBS
Pág. 40	Instalación: activación de los terminales
Pág. 41	Instalación: configuración de la intercara
Pág. 42	Funcionamiento: graficos de compensación de carga
Pág. 43	Funcionamiento: panel de control - Especificaciones técnicas



## KTB4

L'interfaccia a 4 canali KTB4 effettua la compensazione di carica delle batterie collegate ai caricabatterie della serie SBC ADV PLUS medium e high power.

Gli importanti vantaggi che il KTB4 offre sono:

- Possibilità di misurare la temperatura di una, due, tre o quattro batterie (a seconda del numero di sensori collegati).
- Possibilità di collegare fino a 32 interfacce KTB4 allo stesso caricabatterie.
- Alimentazione universale (12/24 Vdc).
- Interfaccia Can Bus per il trasferimento dati.
- Facilità di installazione.

## INSTALLAZIONE



**PRIMA DI UTILIZZARE L'INTERFACCIA, LEGGERE ATTENTAMENTE IL PRESENTE MANUALE D'USO. IN CASO DI DUBBI CONTATTARE IL RIVENDITORE O IL SERVIZIO CLIENTI QUICK®.**



In caso di discordanze o eventuali errori tra il testo tradotto e quello originario in italiano, fare riferimento al testo italiano o inglese.



Questo dispositivo è stato progettato e realizzato per essere utilizzato su imbarcazioni da diporto. Non è consentito un utilizzo differente senza autorizzazione scritta da parte della società Quick®.

Lo strumento KTB4 è stato progettato per gli scopi descritti in questo manuale d'uso. La società Quick® non si assume alcuna responsabilità per danni diretti o indiretti causati da un uso improprio dell'apparecchio, da un'errata installazione o da possibili errori presenti in questo manuale.

**LA MANOMISSIONE DELLO STRUMENTO DA PARTE DI PERSONALE NON AUTORIZZATO FA DECADERE LA GARANZIA.**

**LA CONFEZIONE CONTIENE:** interfaccia KTB4 - sensore KTBS - cavo di collegamento - condizioni di garanzia - il presente manuale d'uso.

### INSTALLAZIONE DELL'INTERFACCIA

Di seguito sarà descritta una procedura di installazione tipica.

Non è possibile descrivere una procedura che sia applicabile a tutte le situazioni.

Adattare questa procedura per soddisfare i propri requisiti.

- L'interfaccia deve essere posizionata in modo che sia facilmente raggiungibile dall'operatore.
- Scegliere una posizione che sia pulita, liscia e piana.
- Porre particolare attenzione quando si effettuano i fori nella superficie dove sarà fissata l'interfaccia KTB4. Questi fori non devono indebolire o causare rotture alla struttura dell'imbarcazione.

L'interfaccia risponde agli standard EMC (compatibilità elettromagnetica) ma è richiesta una corretta installazione per non compromettere le proprie prestazioni e quelle degli strumenti posti nelle vicinanze.

Per questo motivo l'interfaccia deve essere distante almeno:

- 25 cm dalla bussola.
- 50 cm da un qualsiasi apparecchio radio ricevente.
- 1 m da qualsiasi apparato radiotrasmittente (escluso SSB).
- 2 m da qualsiasi apparato radiotrasmittente SSB.
- 2 m dal percorso del fascio radar.



## COLLEGAMENTO ELETTRICO

L'interfaccia risponde agli standard EMC (compatibilità elettromagnetica) ma è richiesta una corretta installazione per non compromettere le proprie prestazioni e quelle degli strumenti posti nelle vicinanze. Per questo motivo i cavi dell'interfaccia devono essere distanti almeno:

- 1 m dai cavi che trasportano segnale radio (escluso di radiotrasmittenti SSB).
- 2 m dai cavi che trasportano segnale radio di radiotrasmittenti SSB.

Seguire le regole riportate di seguito per la realizzazione dell'impianto elettrico relativo all'interfaccia:

- Alimentare l'interfaccia solo dopo aver effettuato e verificato l'esattezza di tutti i collegamenti elettrici.
- Inserire un interruttore per accendere e spegnere l'interfaccia.
- Inserire un fusibile rapido da 100 mA sulla linea di alimentazione dell'interfaccia.
- Utilizzare come collegamento dell'interfaccia dati (segnali CANH e CANL) un cavo non schermato con una coppia intrecciata (sezione 0.25/ 0.35 mm<sup>2</sup> AWG 22/24, impedenza 100/150 ohm).
- Il sensore KTBS non ha polarità per cui i cavi possono essere collegati in un ordine qualsiasi.
- La lunghezza massima totale del cavo dati deve essere non superiore a 100 metri.

Sull'interfaccia sono presenti due morsettiere per i vari collegamenti dei segnali elettrici:

### MORSETTIERA M1

SEGNALE	DESCRIZIONE
+ V SUPPLY (+)	Positivo alimentazione strumento
- V SUPPLY (-)	Negativo alimentazione strumento
CANH (H)	Interfaccia CAN
CANL (L)	Interfaccia CAN

### MORSETTIERA M2

SEGNALI	DESCRIZIONE
SENS1	Sensore KTBS 1
SENS2	Sensore KTBS 2
SENS3	Sensore KTBS 3
SENS4	Sensore KTBS 4



## SCHEMA TIPOICO DI COLLEGAMENTO

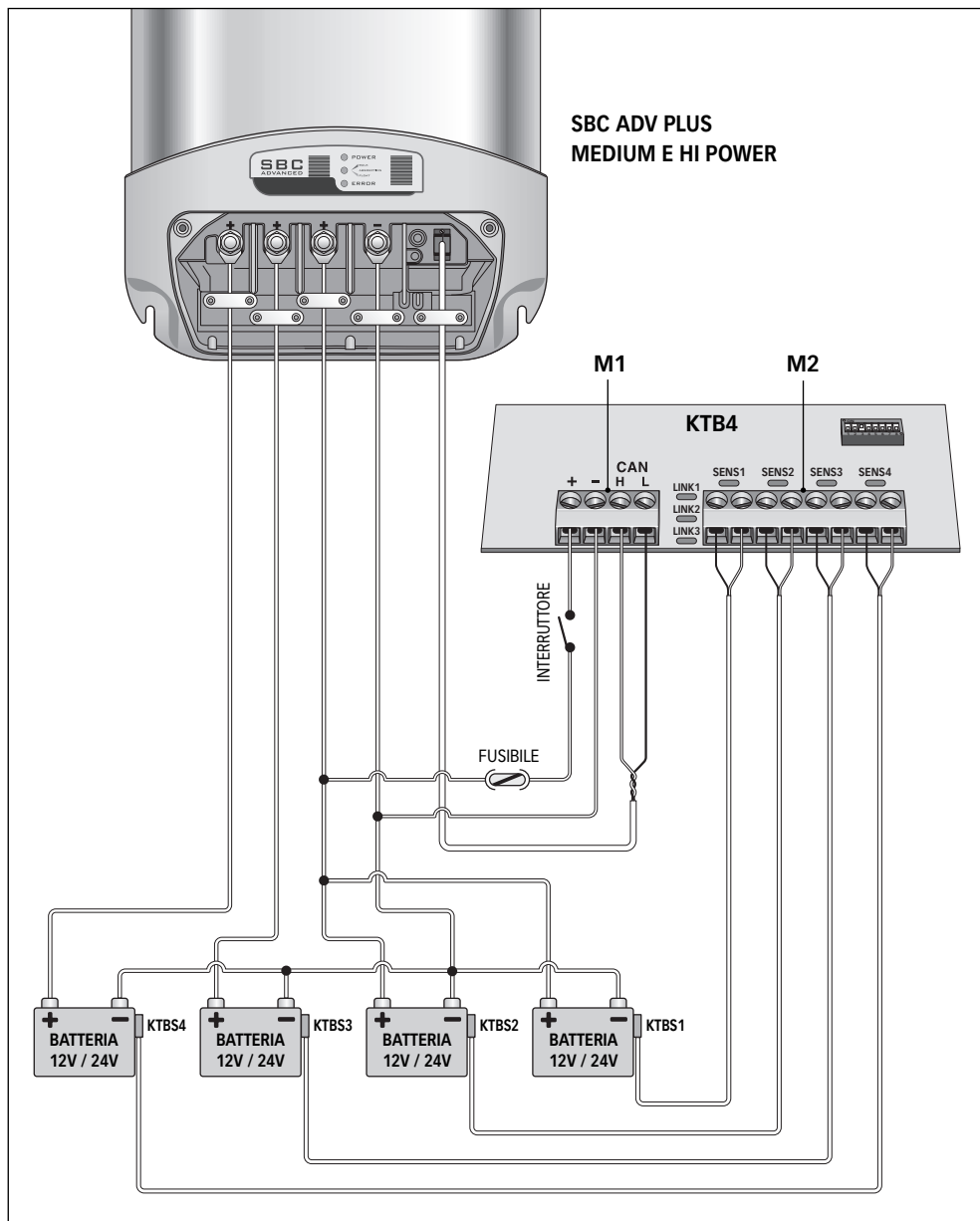



## INSTALLAZIONE DEL SENSORE DI TEMPERATURA KTBS

- Pulire accuratamente la superficie della batteria dove sarà applicato il KTBS.
- Rimuovere la pellicola di protezione dell'adesivo.
- Applicare il KTBS sulla superficie della batteria esercitando una pressione per 30 secondi.

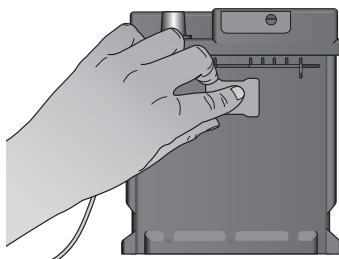
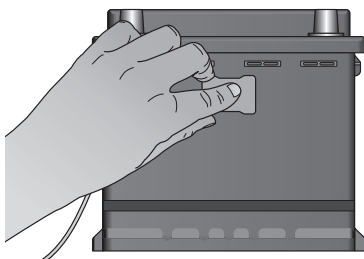
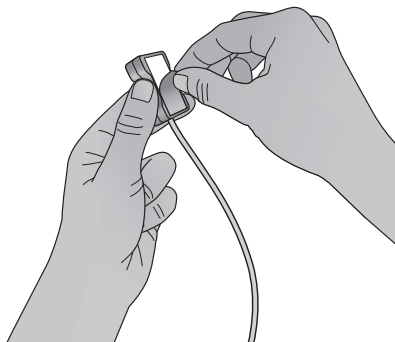
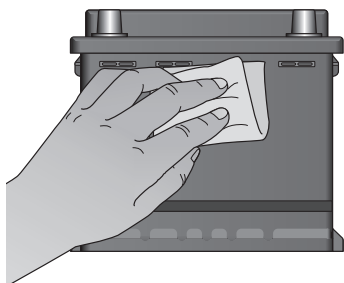

- Il KTBS non deve essere applicato nelle seguenti posizioni:

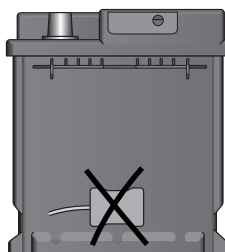
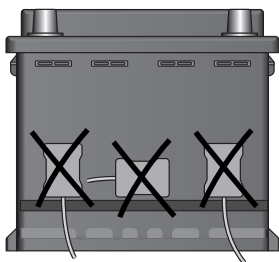

**ATTENZIONE:** l'applicazione sulla batteria del KTBS non è consigliata se la temperatura della superficie della batteria è inferiore a 10°C. La completa adesione del KTBS avverrà dopo 72 ore dall'applicazione.



### ATTIVAZIONE DEI TERMINATORI

Attivare la terminazione sul primo e sull'ultimo dispositivo collegato alla rete.

Per attivare la terminazione sullo strumento, vedere fig. 1 e paragrafo CONFIGURAZIONE DELL'INTERFACCIA.

Di seguito si riporta un esempio di collegamento della rete:

FIG. 1

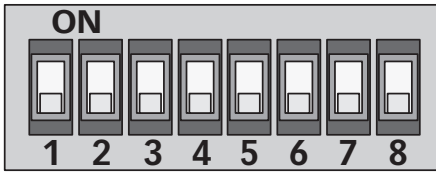

DIP-SWITCH

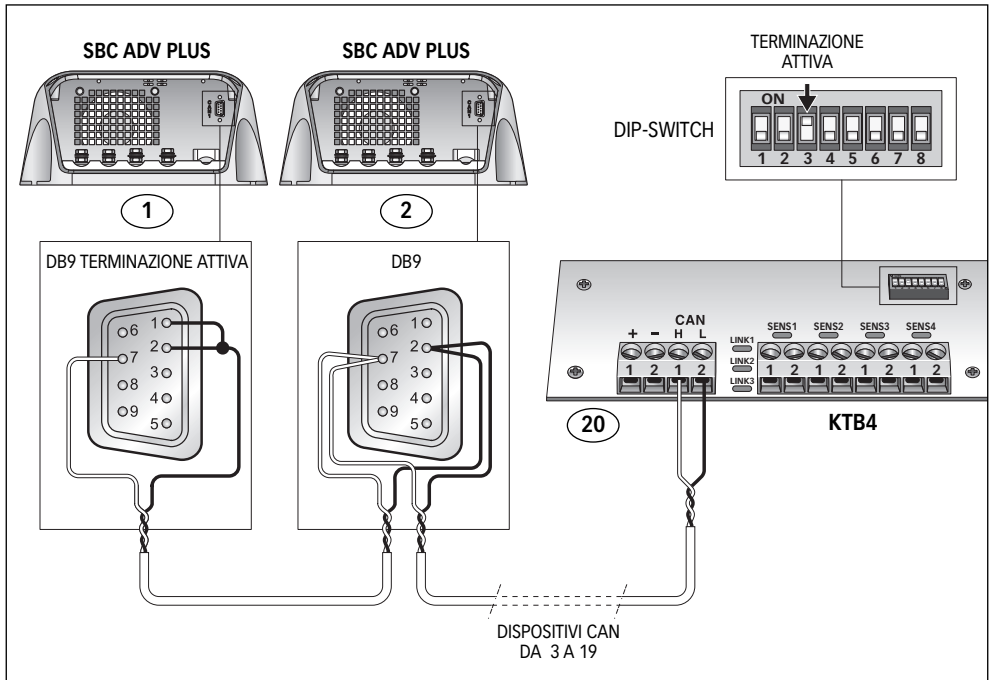







## CONFIGURAZIONE DELL'INTERFACCIA

L'impostazione dell'interfaccia avviene tramite un dip-switch. Per configurare il gruppo del caricabatterie a cui si vogliono inviare le temperature delle batterie, la terminazione CAN e l'indirizzo di identificazione dell'interfaccia KTB4, riferirsi alla tabella che viene riportata di seguito:

SWITCH 1	SWITCH 2	FUNZIONE	DESCRIZIONE
OFF	OFF	GRUPPO A	
OFF	ON	GRUPPO B	
ON	OFF	GRUPPO C	

SWITCH 3	FUNZIONE	DESCRIZIONE
OFF	TERMINATORE CAN DISATTIVATO	
ON	TERMINATORE CAN ATTIVATO	

SWITCH 4	SWITCH 5	SWITCH 6	SWITCH 7	SWITCH 8	INDIRIZZO KTB4
OFF	OFF	OFF	OFF	OFF	0
OFF	OFF	OFF	OFF	ON	1
OFF	OFF	OFF	ON	OFF	2
OFF	OFF	OFF	ON	ON	3
OFF	OFF	ON	OFF	OFF	4
OFF	OFF	ON	OFF	ON	5
OFF	OFF	ON	ON	OFF	6
OFF	OFF	ON	ON	ON	7
OFF	ON	OFF	OFF	OFF	8
OFF	ON	OFF	OFF	ON	9
OFF	ON	OFF	ON	OFF	10
OFF	ON	OFF	ON	ON	11
OFF	ON	ON	OFF	OFF	12
OFF	ON	ON	OFF	ON	13
OFF	ON	ON	ON	OFF	14
OFF	ON	ON	ON	ON	15
ON	OFF	OFF	OFF	OFF	16
ON	OFF	OFF	OFF	ON	17
ON	OFF	OFF	ON	OFF	18
ON	OFF	OFF	ON	ON	19
ON	OFF	ON	OFF	OFF	20
ON	OFF	ON	OFF	ON	21
ON	OFF	ON	ON	OFF	22
ON	OFF	ON	ON	ON	23
ON	ON	OFF	OFF	OFF	24
ON	ON	OFF	OFF	ON	25
ON	ON	OFF	ON	OFF	26
ON	ON	OFF	ON	ON	27
ON	ON	ON	OFF	OFF	28
ON	ON	ON	OFF	ON	29
ON	ON	ON	ON	OFF	30
ON	ON	ON	ON	ON	31

Gli indirizzi di una singola interfaccia possono essere scelti in maniera indifferente. Se all'interno dello stesso gruppo sono presenti più interfacce, gli indirizzi devono essere diversi.

**IMPOSTAZIONE DI FABBRICA:** Gruppo caricabatterie : A  
Terminazione CAN : **DISATTIVATA**  
Indirizzo KTB4 : 0



## FUNZIONAMENTO DELL'INTERFACCIA KTB4

Prima di alimentare l'interfaccia assicurarsi che la configurazione del dip-switch sia corretta. Dopo aver collegato l'alimentazione all'interfaccia, tutti i led si accendono per due secondi. Se i collegamenti sono stati effettuati in maniera corretta, il led LINK relativo al caricabatteria collegato resterà sempre acceso.

## GRAFICI DI COMPENSAZIONE DI CARICA

Di seguito si riportano i grafici di compensazione di carica in funzione della temperatura delle batterie:

TENSIONE BATTERIE

[24V]	[12V]
30,00	15,00
29,80	14,90
29,60	14,80
29,40	14,70
29,20	14,60
29,00	14,50
28,80	14,40
28,60	14,30
28,40	14,20
28,20	14,10
28,00	14,00
27,80	13,90
27,60	13,80
27,40	13,70
27,20	13,60
27,00	13,50
26,80	13,40
26,60	13,30
26,40	13,20
26,20	13,10
26,00	13,00
25,80	12,90
25,60	12,80
25,40	12,70
25,20	12,60
25,00	12,50

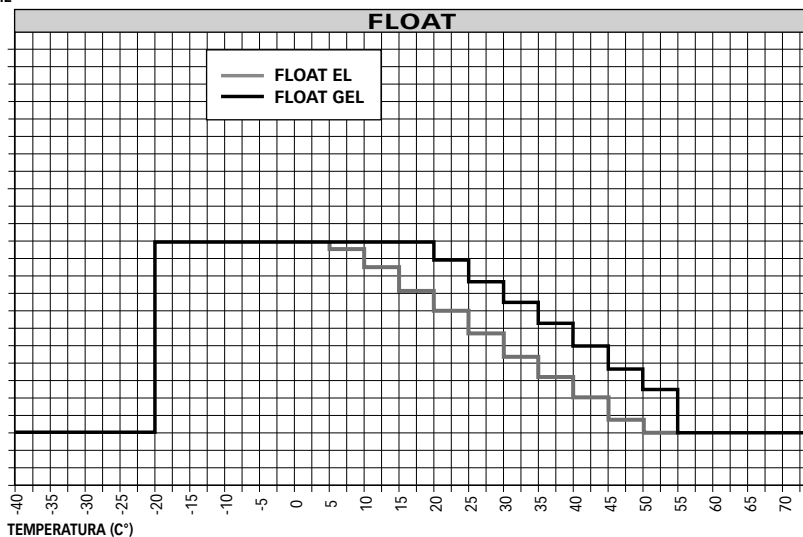

TENSIONE BATTERIE

[24V]	[12V]
30,00	15,00
29,80	14,90
29,60	14,80
29,40	14,70
29,20	14,60
29,00	14,50
28,80	14,40
28,60	14,30
28,40	14,20
28,20	14,10
28,00	14,00
27,80	13,90
27,60	13,80
27,40	13,70
27,20	13,60
27,00	13,50
26,80	13,40
26,60	13,30
26,40	13,20
26,20	13,10
26,00	13,00
25,80	12,90
25,60	12,80
25,40	12,70
25,20	12,60
25,00	12,50

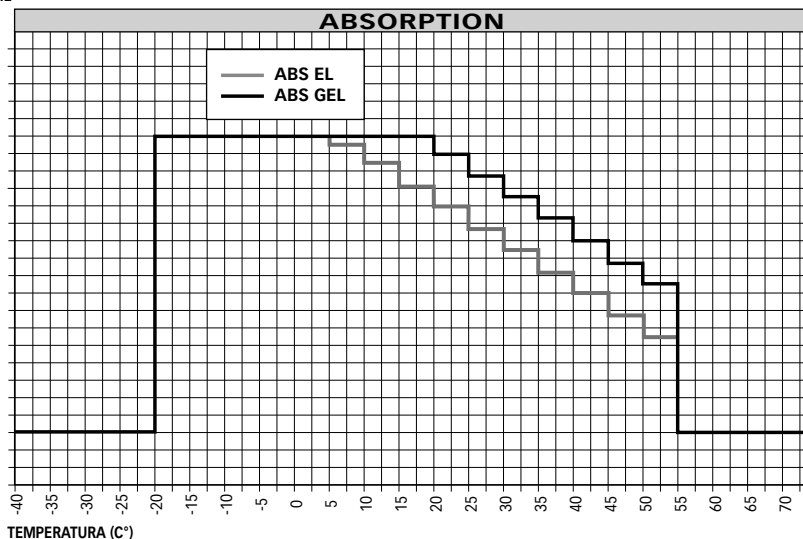



## PANNELLO DI CONTROLLO

Il pannello di controllo dell'interfaccia KTB4, è composto da 7 led:  
3 led gialli (LINK1, LINK2, LINK3) e 4 led verdi (SENS1, SENS2, SENS3, SENS4).

I led LINK possono assumere il seguente stato:

STATO LED	DESCRIZIONE
Spento	L'interfaccia è spenta.
Sempre acceso	Collegamento presente.
Il led lampeggia lentamente	Collegamento non presente. Se il caricabatteria è spento o non è presente all'interno del gruppo, questa segnalazione è corretta. Se il caricabatteria è acceso, verificare il collegamento del cavo di trasmissione dati, la configurazione del gruppo e la terminazione CAN.
Il led lampeggia velocemente	Configurazione del dip-switch errata.

I led SENS possono assumere il seguente stato:

STATO LED	DESCRIZIONE
Spento	Non è collegato alcun sensore.
Sempre acceso	La temperatura delle batterie misurata è nell'intervallo $-40^{\circ}\text{C} / +120^{\circ}\text{C}$ .
Il led lampeggia	La temperatura delle batterie misurata è fuori dall'intervallo di misura $-40^{\circ}\text{C} / +120^{\circ}\text{C}$ . Se il sensore è in corto o è aperto sul display del caricabatterie è visualizzata la "F".

## CARATTERISTICHE TECNICHE

<b>MODELLO</b>	<b>KTB4</b>
----------------	-------------

### CARATTERISTICHE DI INGRESSO

Tensione di alimentazione <sup>(1)</sup>	da 8 a 30 Vdc
Assorbimento massimo	60 mA

### CARATTERISTICHE AMBIENTALI

Temperatura operativa	da $-20$ a $+70^{\circ}\text{C}$
-----------------------	----------------------------------

### GENERALI

Dimensioni (L x A x P)	134 mm x 63 mm x 94 mm
Peso	180 g
Interfaccia di comunicazione	CAN BUS con transceiver differenziale
Classe EMC	EN 55022-B

<sup>(1)</sup> Lo strumento può resettarsi con una tensione di alimentazione inferiore agli 8 Vdc.



## KTB4

The 4-channel KTB4 interface compensates the charge of the batteries connected to the medium and high power SBC ADV PLUS series battery chargers.

Other important advantages which the KTB4 offer, are:

- Possibility of measuring the temperature of one, two, three or four batteries (according to the number of sensors connected).
- Possibility of connecting up to 32 KTB4 interfaces to the same battery charger.
- Universal power supply (12/24Vdc).
- CAN BUS interface for data transfer.
- Easy installation.

## INSTALLATION



**BEFORE USING THE INTERFACE, READ THIS INSTRUCTION MANUAL CAREFULLY.  
IN CASE OF DOUBTS, CONTACT QUICK® CUSTOMER SERVICE OR YOUR LOCAL DEALER.**



In case of discordance or errors in translation between the translated version and the original text in the Italian language, reference will be made to the Italian or English text.



This device was designed and constructed for use on recreational crafts.  
Other forms of use are not permitted without written authorization from the company Quick®.

The KTB4 interface has been designed for the purposes described in this instruction manual. Quick® shall not be held responsible for any direct or indirect property damage or personal injury caused by inappropriate or unintended use of the equipment, erroneous installation or any errors that may be present in this manual.

**THE WARRANTY SHALL BE VOID IF THE INSTRUMENT IS TAMPERED WITH OR ALTERED BY NON AUTHORISED PERSONNEL.**

**THE PACKAGE CONTAINS:** KTB4 interface - KTBS sensor - connecting cable - user's manual - conditions of warranty.

## INTERFACE INSTALLATION

The typical installation procedure is described herein. Needless to say, it is not possible to describe a procedure applicable for all situations that may be encountered.

Adapt this procedure to satisfy your own personal requirements.

- The interface must be positioned so that it can easily be reached by the operator.
- Select a clean, smooth and flat area.
- Take special care when making the holes in the surface where the KTB4 interface will be fixed. The holes must not weaken or cause the breakage of structural elements of the boat.

The interface complies with EMC standards (electromagnetic compatibility) but requires correct installation to avoid compromising its performance and that of the instruments in the vicinity.

For this reason the interface must be positioned at a distance of at least:

- 25 cm away from the compass.
- 50 cm away from any radio receivers.
- 1 m away from any radio transmitters (except for SSB).
- 2 m away from any SSB radio transmitters.
- 2 m away from radar beams.



## ELECTRIC CONNECTIONS

The interface complies with EMC standards (electromagnetic compatibility) but requires correct installation to avoid compromising its performance and that of the instruments in the vicinity. For this reason the cables of the interface must be positioned at a distance of at least:

- 1 m away from cables that carry radio signals (except for SSB radio transmitters).
- 2 m away from cables that carry SSB radio transmitter radio signals.

Follow the rules below to construct the electrical plant relative to the interface:

- Before switching on the power to the interface, check that all the electrical connections are correct.
- Insert a switch to switch the interface on and off.
- Insert a fast-acting 100 mA fuse on the power line to the interface.
- Use an unscreened cable with a braided pair (cross section 0.25/ 0.35 mm<sup>2</sup> AWG 22/24, impedance 100/150 ohm) for data interface connection (CANH and CANL signals).
- The KTBS sensor has no polarity, therefore the wires can be connected in any order.
- The data cable cannot be more than 100 meters long.

There are two terminal clamps on the interface for the various connections to the electrical signals:

### TERMINAL BLOCK M1

SIGNAL	DESCRIPTION
+ V SUPPLY (+)	Instrument positive power supply
- V SUPPLY (-)	Instrument negative power supply
CANH (H)	CAN interface
CANL (L)	CAN interface

### TERMINAL BLOCK M2

SIGNALS	DESCRIPTION
SENS1	KTBS sensor 1
SENS2	KTBS sensor 2
SENS3	KTBS sensor 3
SENS4	KTBS sensor 4



## DIAGRAM OF CONNECTION TYPE

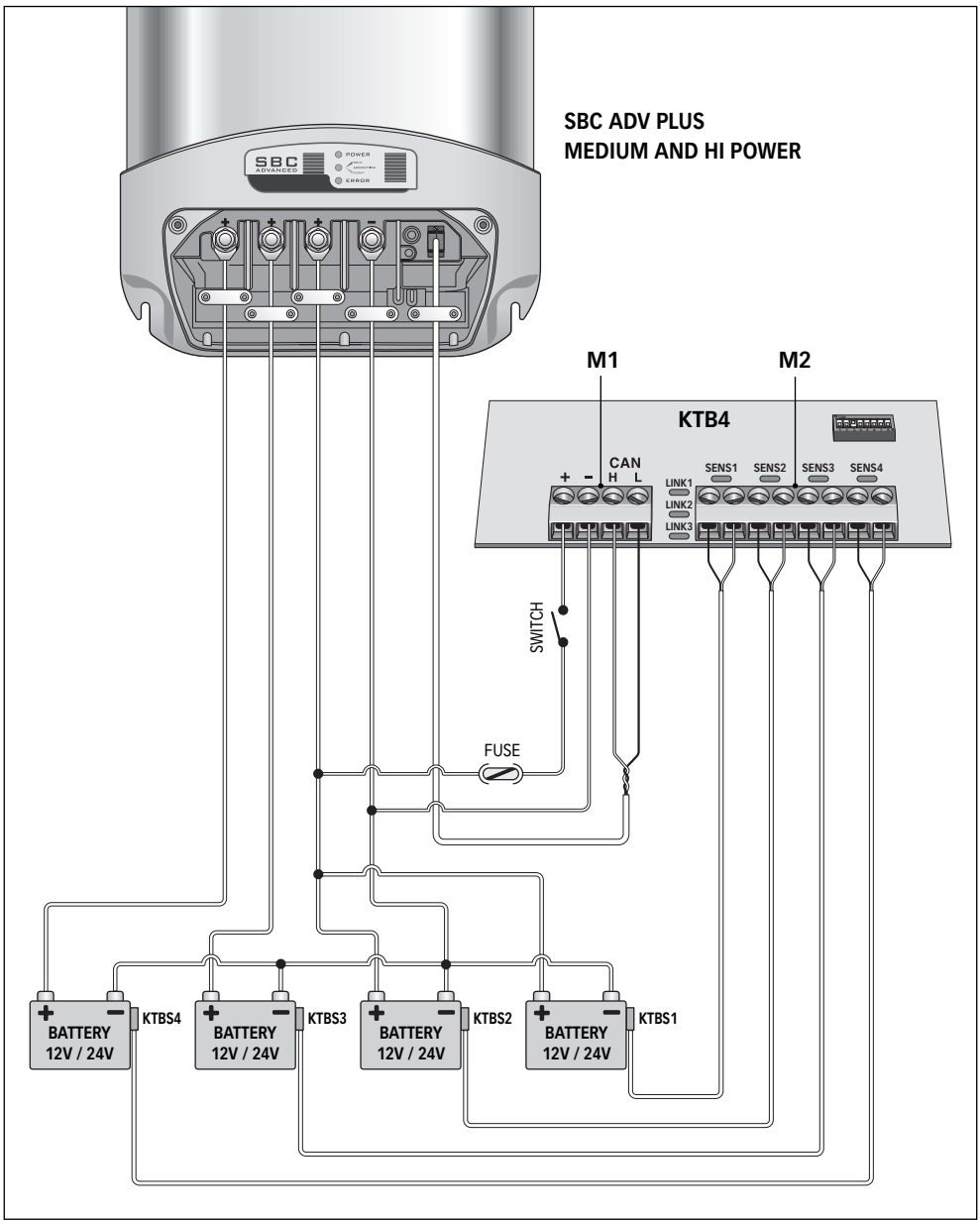



## INSTALLATION OF THE KTBS TEMPERATURE SENSOR

- Thoroughly clean the surface of the battery where the KTBS will be applied.
- Remove the protective adhesive film.
- Apply the KTBS to the battery surface by pressing for 30 seconds.

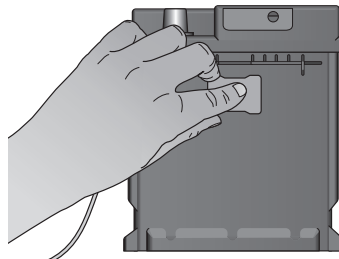
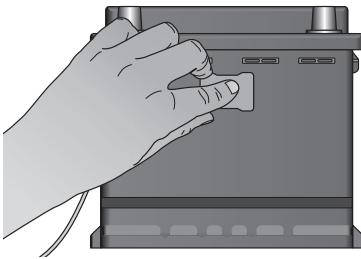
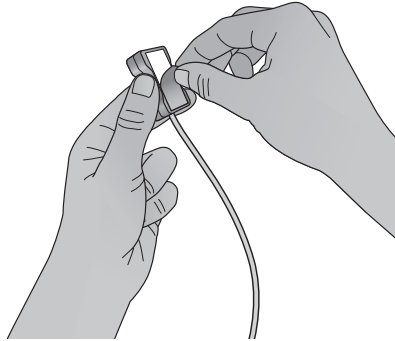
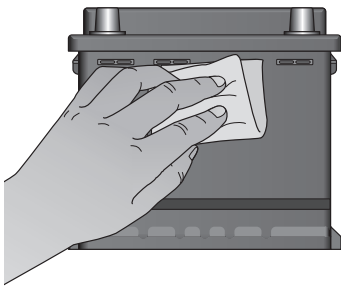

- The KTBS must not be applied in the following positions:

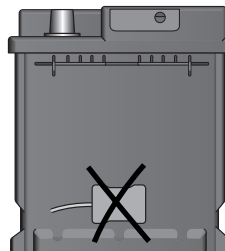
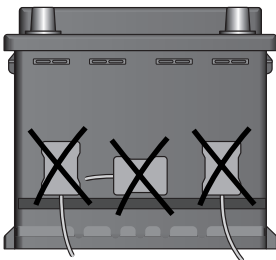

**WARNING:** application of the KTBS on the battery is not recommended if the battery surface temperature is less than 10°C. Secure adhesion of the KTBS will be completely achieved 72 hours after application.



### ACTIVATING THE TERMINATORS

Activate the termination at the first and last device connected to the network.

To activate the instrument termination, see fig. 1 and the paragraph INTERFACE CONFIGURATION.

An example showing network connection is given below:

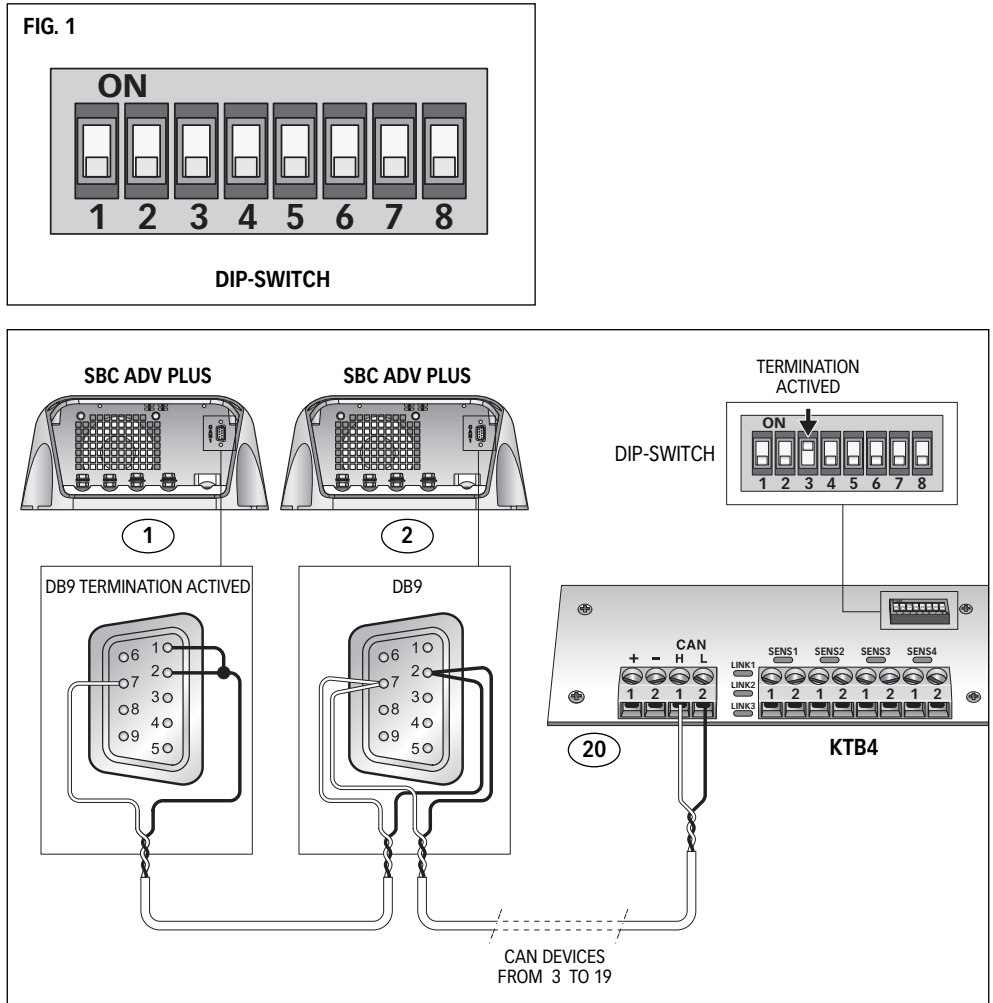









## INTERFACE CONFIGURATION

The interface parameters are set by a dip-switch. To configure the battery charger group to which the temperature of the batteries, the CAN termination and the identification of the KTB4 interface address is to be sent, refer to the table given below:

SWITCH 1	SWITCH 2	FUNCTION	DESCRIPTION
OFF	OFF	GROUP A	
OFF	ON	GROUP B	
ON	OFF	GROUP C	

SWITCH 3	FUNCTION	DESCRIPTION
OFF	CAN TERMINATION DEACTIVATED	
ON	CAN TERMINATION ACTIVATED	

SWITCH 4	SWITCH 5	SWITCH 6	SWITCH 7	SWITCH 8	KTB4 ADDRESS
OFF	OFF	OFF	OFF	OFF	0
OFF	OFF	OFF	OFF	ON	1
OFF	OFF	OFF	ON	OFF	2
OFF	OFF	OFF	ON	ON	3
OFF	OFF	ON	OFF	OFF	4
OFF	OFF	ON	OFF	ON	5
OFF	OFF	ON	ON	OFF	6
OFF	OFF	ON	ON	ON	7
OFF	ON	OFF	OFF	OFF	8
OFF	ON	OFF	OFF	ON	9
OFF	ON	OFF	ON	OFF	10
OFF	ON	OFF	ON	ON	11
OFF	ON	ON	OFF	OFF	12
OFF	ON	ON	OFF	ON	13
OFF	ON	ON	ON	OFF	14
OFF	ON	ON	ON	ON	15
ON	OFF	OFF	OFF	OFF	16
ON	OFF	OFF	OFF	ON	17
ON	OFF	OFF	ON	OFF	18
ON	OFF	OFF	ON	ON	19
ON	OFF	ON	OFF	OFF	20
ON	OFF	ON	OFF	ON	21
ON	OFF	ON	ON	OFF	22
ON	OFF	ON	ON	ON	23
ON	ON	OFF	OFF	OFF	24
ON	ON	OFF	OFF	ON	25
ON	ON	OFF	ON	OFF	26
ON	ON	OFF	ON	ON	27
ON	ON	ON	OFF	OFF	28
ON	ON	ON	OFF	ON	29
ON	ON	ON	ON	OFF	30
ON	ON	ON	ON	ON	31

The addresses of a single interface can be chosen indifferently. If there is more than one interface inside the same group, the addresses must be different.

### FACTORY SETTING:

Battery charger group : A  
CAN termination : **DEACTIVATED**  
KTB4 address : 0



**KTB4 INTERFACE FUNCTIONING**

Before switching on power to the interface, check that the dip-switch configuration is correct. After connecting the power to the interface, all the leds come on for two seconds. If the connections have been made correctly, the LINK led relative to the connected battery charger will always remain on.

**CHARGE COMPENSATION GRAPHS**

The following graphs show charge compensation according to the temperature of the batteries:

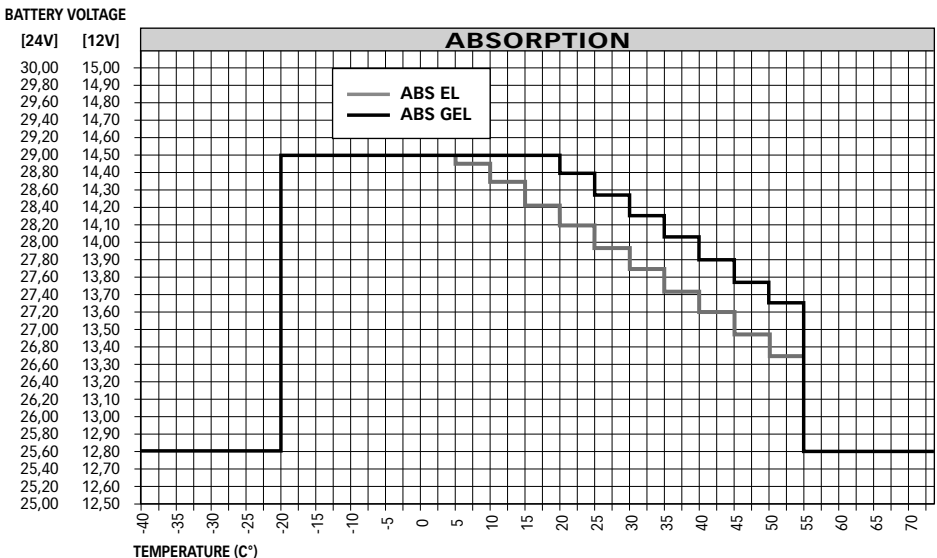
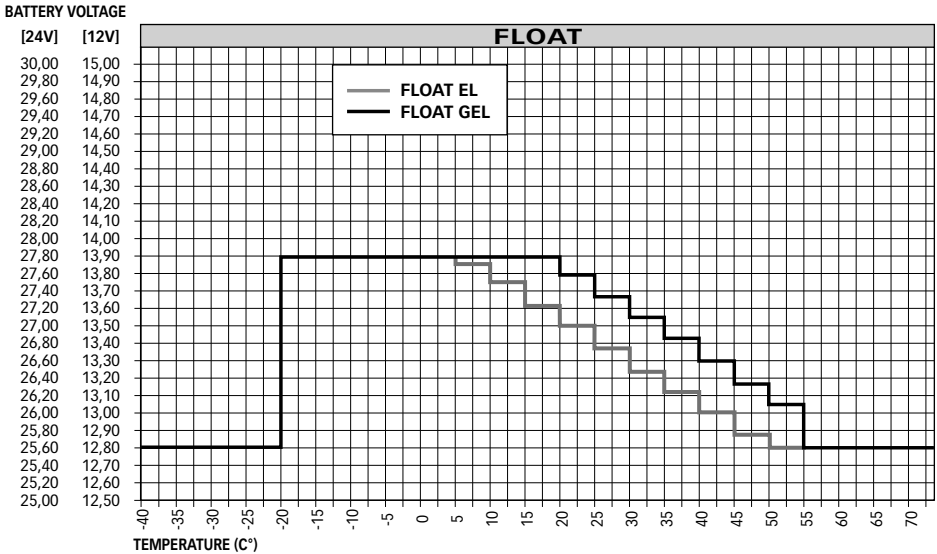



## CONTROL PANEL

The KTB4 interface control panel is composed of 7 leds: 3 yellow leds (LINK1, LINK2, LINK3) and 4 green leds (SENS1, SENS2, SENS3, SENS4).

The LINK leds can be in the following states:

LED STATE	DESCRIPTION
OFF	The interface is off.
Always ON	Connected
Flashing led	Unconnected If the battery charger is off or not present inside the group, this indication is correct. If the battery charger is switched on, check the connection of the data transmission cable, the unit configuration, and the CAN termination.
Rapidly flashing led	The dip-switch configuration is incorrect.

The SENS leds can be in the following states:

LED STATE	DESCRIPTION
OFF	No sensor is connected.
Always ON	The temperature of the batteries is between -40° C / +120° C.
Flashing led	The temperature of the batteries is outside the range of -40°C +120°C. If the sensor is short-circuited or open, "F" appears on the battery charger display.

## TECHNICAL DATA

<b>MODEL</b>	<b>KT B4</b>
--------------	--------------

### INPUT CHARACTERISTICS

Supply voltage <sup>(1)</sup>	from 8 to 30 Vdc
Maximum absorption	60 mA

### AMBIENT CHARACTERISTICS

Operating temperature	from -20 to +70° C
-----------------------	--------------------

### GENERAL

Dimensions (W x H x D)	134 mm x 63 mm x 94 mm
Weight	180 g
Communication interface	CAN BUS with differential transceiver
EMC Class	EN 55022-B

<sup>(1)</sup> The instrument can reset itself at a voltage less than 8 Vdc.



## KTB4

L'interface à 4 canaux KTB4 effectue la compensation de charge des batteries branchées aux chargeurs de batteries de la série SBC ADV PLUS medium et high power.

D'autres avantages du KTB4 sont:

- Possibilité de mesurer la température d'une, deux, trois ou quatre batteries (selon le nombre de capteurs branchés).
- Possibilité de brancher jusqu'à 32 interfaces KTB4 au même chargeur de batteries.
- Alimentation électrique universelle (12/24Vdc)
- Interface CAN BUS pour le transfert de données.
- Facilité d'installation.

## INSTALLATION



**AVANT D'UTILISER L'INTERFACE, LIRE ATTENTIVEMENT CE LIVRET D'UTILISATION. EN CAS DE DOUTE, CONTACTER LE REVENDEUR OU LE SERVICE APRES VENTE CLIENTS QUICK®.**



En cas de discordances ou d'erreurs éventuelles entre la traduction et le texte original en italien, se référer au texte italien ou anglais.



Ce dispositif a été conçu et réalisé pour être utilisé sur des bateaux de plaisance. Tout autre emploi est interdit sans autorisation écrite de la société Quick®.

L'interface KTB4 a été conçue pour les utilisations décrites dans ce livret d'utilisation. La société Quick® ne peut être tenue responsable des dommages directs ou indirects causés par une utilisation impropre de l'appareil, par une mauvaise installation ou par de possible erreurs présentes dans ce livret.

**L'ENDOMMAGEMENT DE L'INSTRUMENT PAR UN PERSONNEL NON AUTORISE ENTRAINE L'ANNULATION DE LA GARANTIE.**

L'emballage contient les éléments suivants: Interface KTB4 - capteur KTBS - câble de branchement - conditions de garantie - manuel de l'utilisateur.

## INSTALLATION DE L'INTERFACE

Ci-dessous nous avons décrit une procédure d'installation typique.

Il est impossible de décrire une procédure qui soit applicable à toutes les situations.

Adapter cette procédure afin de répondre à vos exigences propres.

- L'interface doit être placée de manière à être facilement accessible par l'opérateur.
- Choisir un emplacement qui est propre, lisse et plan.
- Faire très attention en faisant les trous sur la surface où l'interface KTB4 sera fixée. Ces trous ne doivent pas affaiblir ou provoquer de ruptures à la structure du bateau.

L'interface est conforme aux standards EMC (compatibilité électromagnétique), mais une bonne installation est requise afin de ne pas compromettre ses performances ainsi que celles des instruments situés à proximité. Pour ces motifs, l'interface doit être distante d'au moins :

- 25 cm de la boussole.
- 50 cm d'un appareil radio récepteur quelconque.
- 1 m d'un appareil radio transmetteur quelconque (sauf SSB).
- 2 m d'un appareil radio transmetteur quelconque SSB.
- 2 m du parcours de la bande radar.



## BRANCHEMENT ELECTRIQUE

L'interface est conforme aux standards EMC (compatibilité électromagnétique), mais une bonne installation est requise afin de ne pas compromettre ses performances ainsi que celles des instruments situés à proximité. Pour ce motif, les câbles de l'interface doivent être distants d'au moins:

- 1 m des câbles qui transportent le signal radio (sauf de radio transmetteurs SSB).
- 2 m des câbles qui transportent le signal radio de radio transmetteurs SSB.

Suivre les règles indiquées ci-après pour réaliser l'installation électrique de l'interface:

- Alimenter l'interface uniquement après avoir effectué et vérifié l'exactitude de tous les branchements électriques.
- Brancher un interrupteur pour allumer et éteindre l'interface.
- Placer un fusible rapide de 100 mA sur la ligne d'alimentation de l'interface.
- Utiliser comme connexion de l'interface données (signaux CANH et CANL) un câble non blindé avec un couple tressé (section 0.25/ 0.35 mm<sup>2</sup> AWG 22/24, impédance 100/150 ohm).
- Le capteur KTBS n'a pas de polarité, donc les câbles peuvent être branchés dans n'importe quel ordre.
- La longueur maximale totale du câble données doit être inférieure à 100 mètres.

Deux plaques à bornes se trouvent sur l'interface pour les divers branchements des signaux électriques:

### BARRETTE M1

SIGNAL	DESCRIPTION
+ V SUPPLY (+)	Positif alimentation instrument
- V SUPPLY (-)	Négatif alimentation instrument
CANH (H)	Interface CAN
CANL (L)	Interface CAN

### BARRETTE M2

SEGNAUX	DESCRIPTION
SENS1	Capteur KTBS 1
SENS2	Capteur KTBS 2
SENS3	Capteur KTBS 3
SENS4	Capteur KTBS 4



## SCHEMA TYPIQUE DE BRANCHEMENT

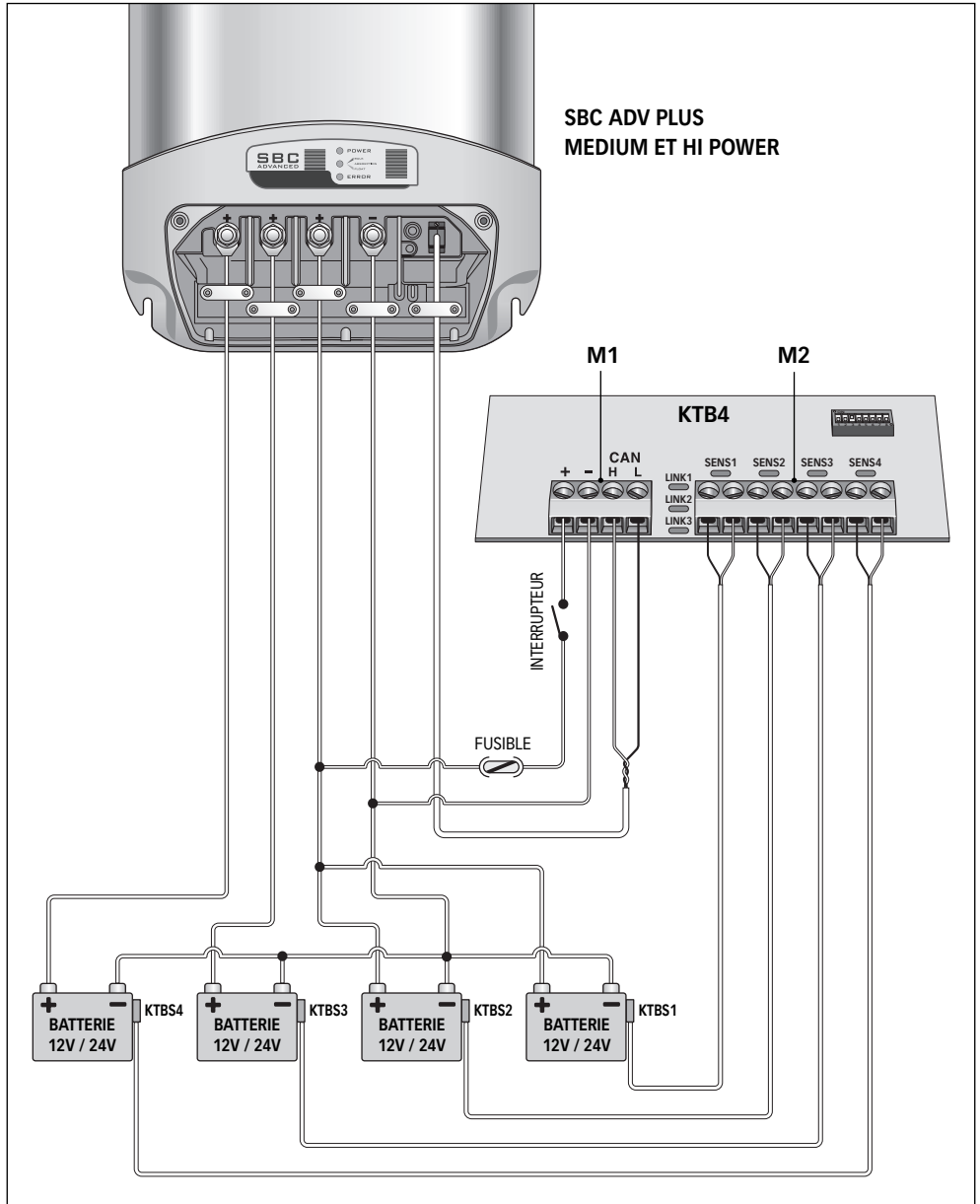



## INSTALLATION DU CAPTEUR DE TEMPERATURE KTBS

- Nettoyer soigneusement la surface de la batterie où le KTBS sera appliqué.
- Enlever la pellicule de protection de l'adhésif.
- Appliquer le KTBS sur la surface de la batterie en exerçant une pression pendant 30 secondes.

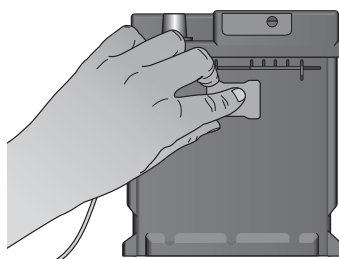
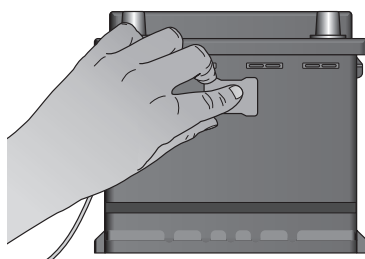
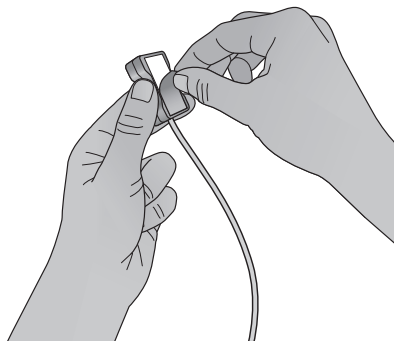
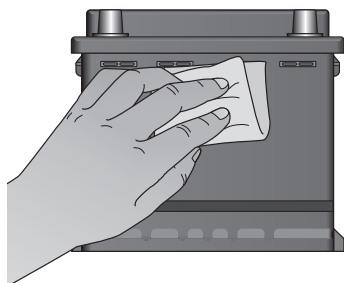

- Le KTBS ne doit pas être appliqué dans les positions suivantes:

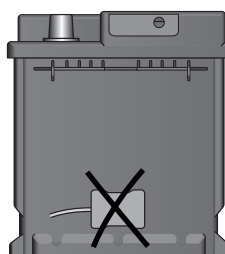
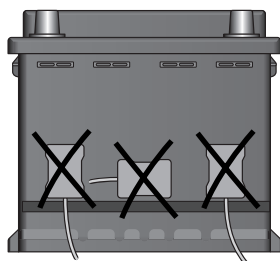

**ATTENTION:** l'application du KTBS sur la batterie est déconseillée si la température de la surface de la batterie est inférieure à 10°C. Le KTBS adhèrera totalement 72 heures après son application.



### ACTIVATION DES TERMINAUX

Activer la terminaison sur le premier et sur le dernier dispositif relié au réseau.

Pour activer la terminaison sur l'instrument, voir la fig. 1 et le paragraphe CONFIGURATION DE L'INTERFACE.  
Nous avons reporté ci-dessous un exemple de branchement du réseau:

FIG. 1

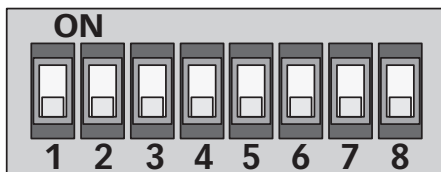

DIP-SWITCH

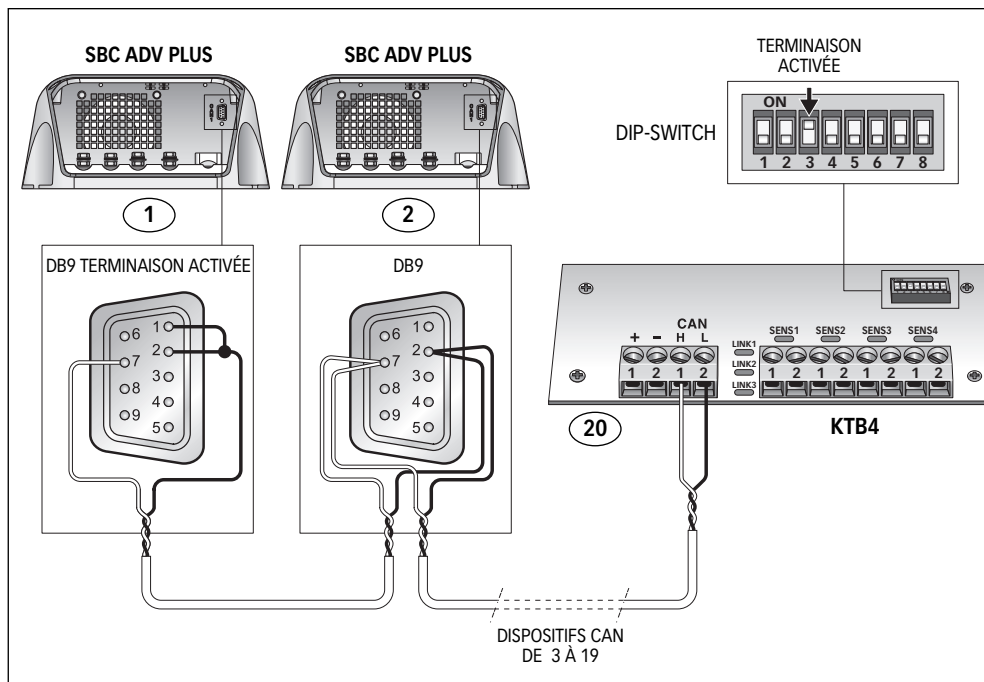





## CONFIGURATION DE L'INTERFACE

La configuration de l'interface s'effectue via les micro-interrupteurs DIP. Pour configurer le groupe du chargeur de batteries auquel on veut envoyer les températures des batteries, la terminaison CAN et l'adresse d'identification de l'interface KTB4, se référer au tableau indiqué ci-après:

SWITCH 1	SWITCH 2	FONCTION	DESCRIPTION
OFF	OFF	GRUPE A	
OFF	ON	GRUPE B	
ON	OFF	GRUPE C	

SWITCH 3	FONCTION	DESCRIPTION
OFF	TERMINAL CAN DÉSACTIVÉ	
ON	TERMINAL CAN ACTIVÉ	

SWITCH 4	SWITCH 5	SWITCH 6	SWITCH 7	SWITCH 8	ADRESSE KTB4
OFF	OFF	OFF	OFF	OFF	0
OFF	OFF	OFF	OFF	ON	1
OFF	OFF	OFF	ON	OFF	2
OFF	OFF	OFF	ON	ON	3
OFF	OFF	ON	OFF	OFF	4
OFF	OFF	ON	OFF	ON	5
OFF	OFF	ON	ON	OFF	6
OFF	OFF	ON	ON	ON	7
OFF	ON	OFF	OFF	OFF	8
OFF	ON	OFF	OFF	ON	9
OFF	ON	OFF	ON	OFF	10
OFF	ON	OFF	ON	ON	11
OFF	ON	ON	OFF	OFF	12
OFF	ON	ON	OFF	ON	13
OFF	ON	ON	ON	OFF	14
OFF	ON	ON	ON	ON	15
ON	OFF	OFF	OFF	OFF	16
ON	OFF	OFF	OFF	ON	17
ON	OFF	OFF	ON	OFF	18
ON	OFF	OFF	ON	ON	19
ON	OFF	ON	OFF	OFF	20
ON	OFF	ON	OFF	ON	21
ON	OFF	ON	ON	OFF	22
ON	OFF	ON	ON	ON	23
ON	ON	OFF	OFF	OFF	24
ON	ON	OFF	OFF	ON	25
ON	ON	OFF	ON	OFF	26
ON	ON	OFF	ON	ON	27
ON	ON	ON	OFF	OFF	28
ON	ON	ON	OFF	ON	29
ON	ON	ON	ON	OFF	30
ON	ON	ON	ON	ON	31

Les adresses d'une seule interface peuvent être choisies indifféremment. Si plusieurs interfaces sont présentes dans le même groupe, les adresses doivent être différentes.

### PARAMÉTRAGE D'USINE :

Groupe chargeur de batteries : **A**  
Terminal CAN désactivé : **DÉSACTIVÉ**  
Adresse KTB4 : **0**



## FONCTIONNEMENT DE L'INTERFACE KTB4

Avant d'alimenter l'interface, vérifier si la configuration micro-interrupteurs DIP est correcte. Après avoir branché l'alimentation à l'interface, tous les led s'allument pendant deux secondes. Si les branchements ont été correctement effectués, le led LINK relatif au chargeur de batteries branché restera toujours allumé.

## GRAPHIQUES DE COMPENSATION DE CHARGE

Voici ci-après, les graphiques de compensation de chargement en fonction de la température des batteries:

TENSION BATTERIES

[24V] [12V]

30,00	15,00
29,80	14,90
29,60	14,80
29,40	14,70
29,20	14,60
29,00	14,50
28,80	14,40
28,60	14,30
28,40	14,20
28,20	14,10
28,00	14,00
27,80	13,90
27,60	13,80
27,40	13,70
27,20	13,60
27,00	13,50
26,80	13,40
26,60	13,30
26,40	13,20
26,20	13,10
26,00	13,00
25,80	12,90
25,60	12,80
25,40	12,70
25,20	12,60
25,00	12,50

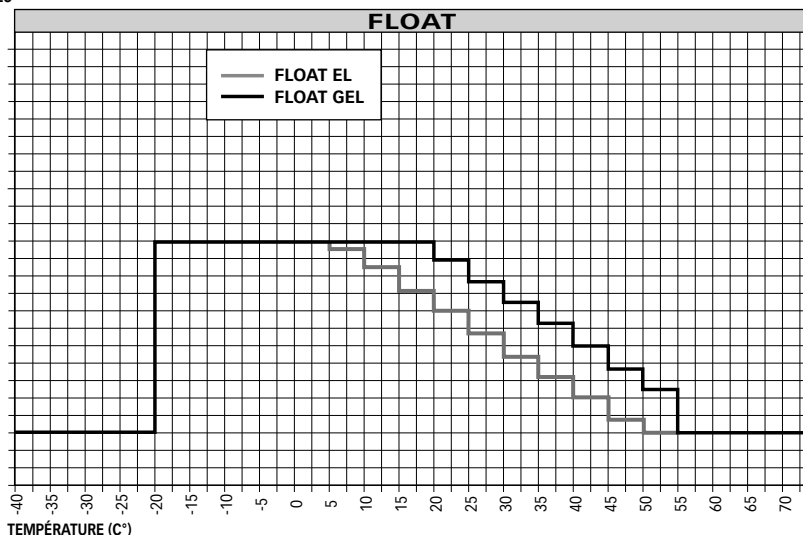

TENSION BATTERIES

[24V] [12V]

30,00	15,00
29,80	14,90
29,60	14,80
29,40	14,70
29,20	14,60
29,00	14,50
28,80	14,40
28,60	14,30
28,40	14,20
28,20	14,10
28,00	14,00
27,80	13,90
27,60	13,80
27,40	13,70
27,20	13,60
27,00	13,50
26,80	13,40
26,60	13,30
26,40	13,20
26,20	13,10
26,00	13,00
25,80	12,90
25,60	12,80
25,40	12,70
25,20	12,60
25,00	12,50

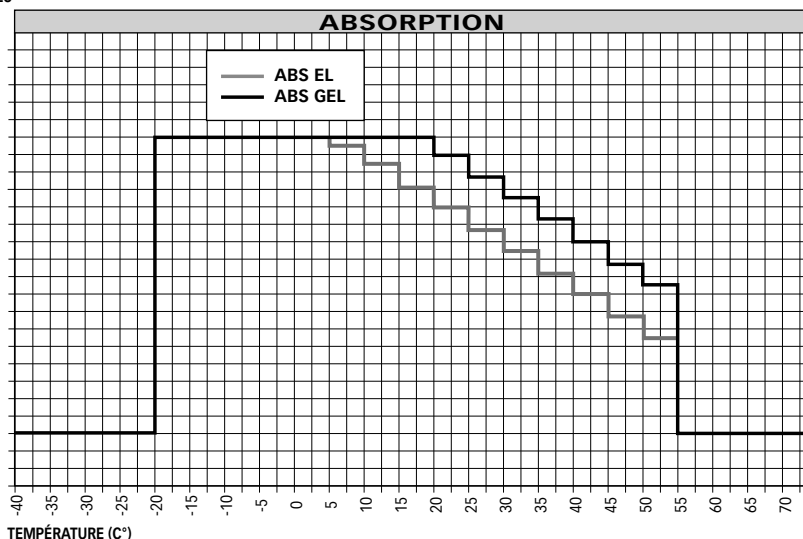



## TABLEAU DE CONTRÔLE

Le tableau de contrôle de l'interface KTB4, se compose de 7 led:

3 led jaunes (LINK1, LINK2, LINK3) et 4 led verts (SENS1, SENS2, SENS3, SENS4).

Les led LINK peuvent prendre l'état suivant:

MODE LED	DESCRIPTION
Eteinte	L'interface est éteinte.
Toujours allumé	Branchement présent.
Le led clignote lentement	Absence de branchement. Si le chargeur de batteries est éteint ou n'est pas présent à l'intérieur du groupe, ce signal est correct. Si le chargeur de batteries est allumé, vérifier le branchement du câble de transmission des données, la configuration du groupe et la terminaison CAN.
Le led clignote rapidement	Configuration du dip-switch erronée.

Les led SENS peuvent prendre l'état suivant:

MODE LED	DESCRIPTION
Eteinte	Aucun capteur n'est branché.
Toujours allumé	La température des batteries mesurée se situe dans l'intervalle $-40^{\circ}\text{C}$ / $+120^{\circ}\text{C}$ .
Le led clignote	La température des batteries mesurée se situe en dehors de l'intervalle de mesure $-40^{\circ}\text{C}$ $+120^{\circ}\text{C}$ . L'afficheur du chargeur de batteries affiche le signal "F" si le capteur est en court-circuit ou s'il est ouvert.

## CARACTÉRISTIQUES TECHNIQUES

<b>MODÈLE</b>	<b>KTB4</b>
---------------	-------------

### CARACTÉRISTIQUES D'ENTRÉE

Tension d'alimentation <sup>(1)</sup>	de 8 à 30 Vdc
Consommation maximale	60 mA

### CARACTÉRISTIQUES AMBIANTES

Température de fonctionnement	de $-20$ à $+70^{\circ}\text{C}$
-------------------------------	----------------------------------

### CARACTÉRISTIQUES GÉNÉRALES

Dimensions (L x H x P)	134 mm x 63 mm x 94 mm
Poids	180 g
Interface de communication	CAN BUS avec transceiver différentiel
Classe EMC	EN 55022-B

<sup>(1)</sup> L'instrument peut être restauré avec une tension d'alimentation inférieure aux 8 Vdc.



## RDS 1540

Die 4-Kanal-Schnittstelle KTB4 bewirkt den Ladungsausgleich der Batterien, die an die Batterieladegeräte der Serie SBC ADV Plus Medium und High Power angeschlossen sind.

Die Überwachungspaneel KTB4 bieten die folgenden wesentlichen Vorteile:

- Möglichkeit zur Temperaturmessung von einer, zwei, drei oder vier Batterien (je nachdem wie viele Sensoren angeschlossen sind).
- Möglichkeit zum Anschluss von bis zu 32 Schnittstellen KTB4 an ein einziges Batterieladegerät.
- Universalspeisung (12/24Vdc).
- CAN BUS-Schnittstelle zur Datenübertragung.
- Einfache Installation.

## INSTALLATION



**VOR BENUTZUNG DER SCHNITTSTELLE DIE VORLIEGENDE GEBRAUCHSANWEISUNG AUFMERKSAM DURCHLESEN. KONTAKTIEREN SIE BITTE IM ZWEIFELSFALL ODER BEI UNKLARHEITEN IHREN HÄNDLER ODER DEN QUICK®-KUNDENDIENST.**



Bei Fehlern oder eventuellen Unstimmigkeiten zwischen der Übersetzung und dem Ausgangstext ist der Ausgangstext in Italienisch oder Englisch maßgeblich.



Diese Vorrichtung wurde für den Einsatz auf Sportbooten entwickelt und realisiert. Ohne schriftliche Zustimmung durch Quick® ist keine anderweitige Nutzung zulässig.

Die Schnittstelle KTB4 wurde für die in dieser Gebrauchsanweisung beschriebenen Zwecke entwickelt. Quick® übernimmt keinerlei Verantwortung für direkte oder indirekte Schäden, die auf einen unsachgemäßen Gebrauch des Gerätes, auf eine falsche Installation oder auf mögliche, in diesem Handbuch enthaltene Fehler zurückzuführen sind.

**DER BETRIEB DES GERÄTES DURCH NICHT AUTORISIERTE PERSONEN FÜHRT ZUM VERFALL DER GARANTIE.**

**IM LIEFERUMFANG:** Schnittstelle KTB4 - Sensor KTBS - Anschlusskabel - Betriebsanleitung - Garantiebedingungen.

## INSTALLATION DER SCHNITTSTELLE

Im Nachfolgenden wird ein typisches Installationsverfahren beschrieben.

Es ist nicht möglich, ein Verfahren zu beschreiben, dass sich auf alle Situationen anwenden lässt.

Dieses Verfahren muss demnach den jeweiligen persönlichen Bedürfnissen angepasst werden.

- Die Schnittstelle muss so positioniert sein, dass der Bediener sie einfach erreichen kann.
- Eine saubere, glatte und ebene Position auswählen.
- Die Oberfläche, an der die Schnittstelle KTB4 befestigt werden soll, sehr vorsichtig bohren. Diese Bohrungen dürfen die Struktur des Bootes weder abschwächen noch beschädigen.

Die Schnittstelle entspricht den EMC-Normen (elektromagnetische Verträglichkeit), erfordert aber eine korrekte Installation, um ihre Leistungsfähigkeit und die anderer Instrumente in ihrer Nähe nicht zu beeinträchtigen. Aus diesem Grund muss die Schnittstelle folgende Mindestabstände einhalten:

- 25 cm vom Kompass.
- 50 cm von einem beliebigen Funkempfangsgerät.
- 1 m von einem beliebigen Funksendegerät (SSB ausgeschlossen).
- 2 m von einem beliebigen SSB-Funksendegerät.
- 2 m vom Strahlengang des Radarstrahlenbündels.



## STROMANSCHLUSS

Die Schnittstelle entspricht den EMC-Normen (elektromagnetische Verträglichkeit), erfordert aber eine korrekte Installation, um ihre Leistungsfähigkeit und die anderer Instrumente in ihrer Nähe nicht zu beeinträchtigen.

Aus diesem Grund müssen die Kabel der Schnittstelle folgende Mindestabstände einhalten:

- 1 m von den Kabeln, die das Funksignal übertragen (ausgenommen SSB- Funksendegerät).
- 2 m von den Kabeln, die das Funksignal von SSB- Funksendegeräten übertragen.

Zur Ausführung der elektrischen Anlage für die Schnittstelle nachfolgende Hinweise beachten:

- Die Schnittstelle erst dann mit Strom versorgen, wenn alle elektrischen Anschlüsse fertig und richtig gestellt wurden.
- Einen Schalter zum Ein- und Ausschalten der Schnittstelle einbauen.
- Eine flinke Sicherung 100 mA an der Versorgungsleitung der Schnittstelle einbauen.
- Für den Anschluss der Datenschnittstelle (Signale CANH und CANL) ein nicht abgeschirmtes Kabel mit einem verflochtenen Paar verwenden (Querschnitt 0.25/ 0.35 mm<sup>2</sup> AWG 22/24,
- Bei dem Sensor KTBS muss keine Polarität beachtet werden, daher können die Kabel in beliebiger Reihenfolge angeschlossen werden.
- Die maximale Gesamtlänge des Datenkabels darf nicht mehr als 100 Meter betragen.

Auf der Schnittstelle befinden sich zwei Klemmbretter für die verschiedenen Anschlüsse der elektrischen Signale:

### KLEMMEN M1

SIGNAL	BESCHREIBUNG
+ V SUPPLY (+)	Positiv Versorgung Gerät
- V SUPPLY (-)	Negativ Versorgung Gerät
CANH (H)	Schnittstelle CAN
CANL (L)	Schnittstelle CAN

### KLEMMEN M2

SIGNALE	BESCHREIBUNG
SENS1	Sensor KTBS 1
SENS2	Sensor KTBS 2
SENS3	Sensor KTBS 3
SENS4	Sensor KTBS 4



## TYPISCHER SCHALTPLAN

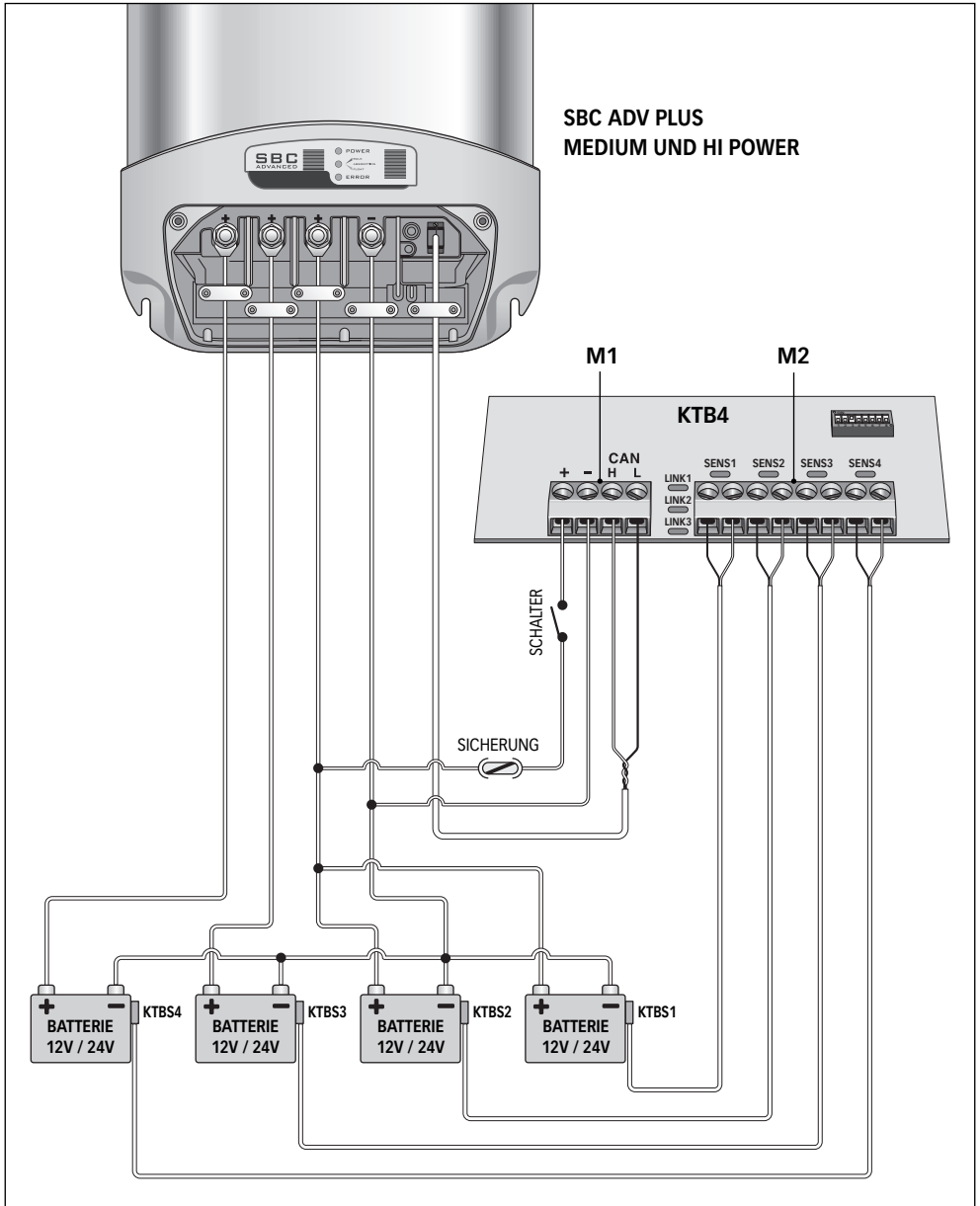



## INSTALLATION DES TEMPERATURENSENSORS KTBS

- Die Oberfläche der Batterie, an der der KTBS angebracht werden soll, sorgfältig reinigen.
- Die Schutzfolie von der Klebefläche entfernen.
- Den KTBS auf der Oberfläche der Batterie anbringen, ihn dazu 30 Sekunden lang andrücken.

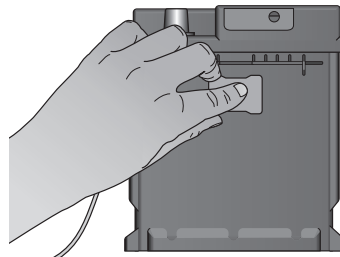
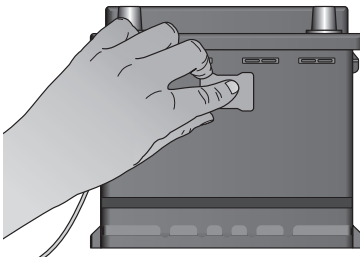
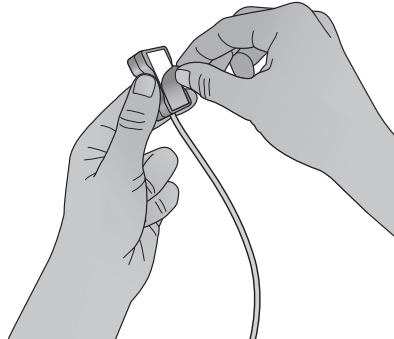
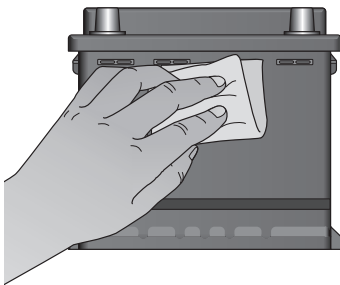

- Der KTBS darf nicht in folgenden Positionen angebracht werden:

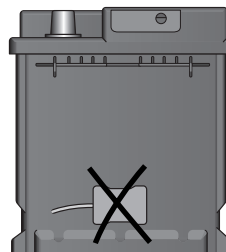
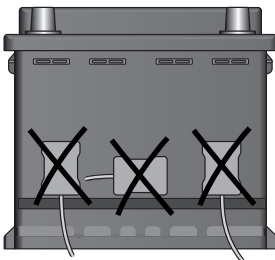

**ACHTUNG:** Es wird empfohlen, den KTBS nicht auf der Batterie anzubringen, wenn die Oberflächentemperatur der Batterie unter 10°C liegt. Das vollständige Anhaften des KTBS erfolgt 72 Stunden nach dem Anbringen.



### AKTIVIERUNG DER ABSCHLUSSWIDERSTÄNDE

Den Abschluss an der ersten und an der letzten am Netz angeschlossenen Vorrichtung aktivieren. Zur Aktivierung des Abschlusses am Gerät siehe Abb. 1 und Abschnitt KONFIGURATION DER SCHNITTSTELLE. Im Folgenden wird ein Beispiel für einen Netzanschluss dargestellt:

ABB. 1

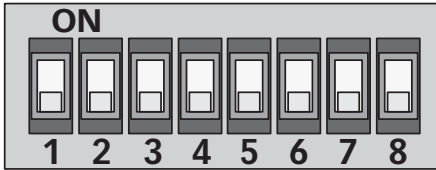

DIP-SWITCH

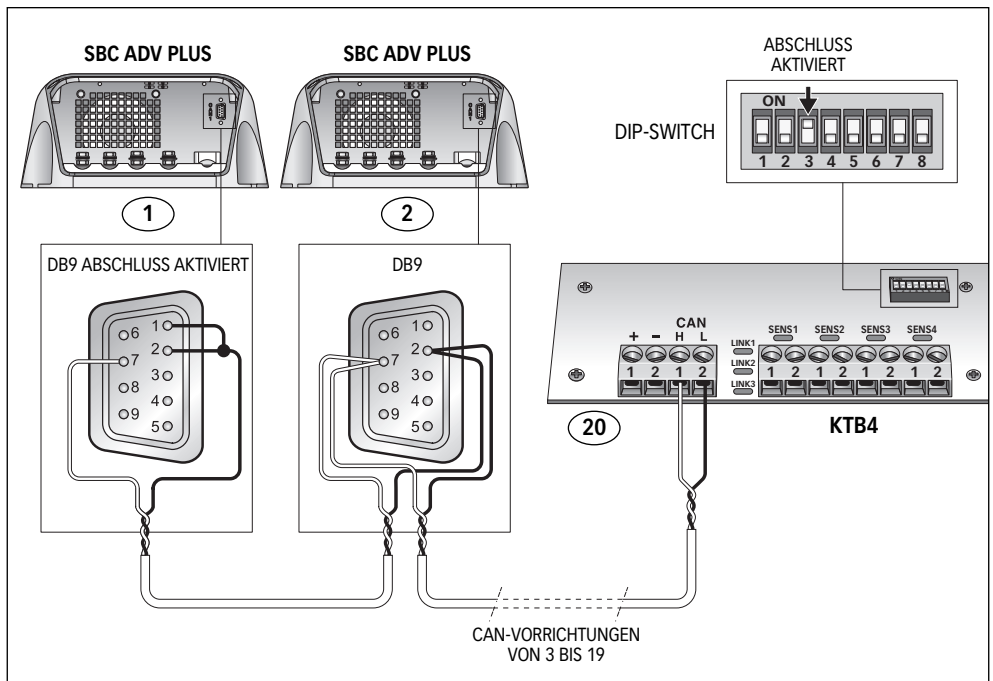





## KONFIGURATION DER SCHNITTSTELLE

Die Einstellung der Schnittstelle erfolgt über einen Dip-Switch. Zur Konfiguration des Batterieladeaggregats, an das die Temperaturwerte der Batterien, das CAN-Abschluss und die Identifizierungsadresse der Schnittstelle KTB4 gesendet werden sollen, siehe nachfolgende Tabelle:

SWITCH 1	SWITCH 2	FUNKTION	BESCHREIBUNG		
OFF	OFF	GRUPPE A			
OFF	ON	GRUPPE B			
ON	OFF	GRUPPE C			
SWITCH 3	FUNKTION		BESCHREIBUNG		
OFF	Abschlusswiderstand CAN DEAKTIVIERT				
ON	Abschlusswiderstand CAN AKTIVIERT				
SWITCH 4	SWITCH 5	SWITCH 6	SWITCH 7	SWITCH 8	ADRESSE KTB4
OFF	OFF	OFF	OFF	OFF	0
OFF	OFF	OFF	OFF	ON	1
OFF	OFF	OFF	ON	OFF	2
OFF	OFF	OFF	ON	ON	3
OFF	OFF	ON	OFF	OFF	4
OFF	OFF	ON	OFF	ON	5
OFF	OFF	ON	ON	OFF	6
OFF	OFF	ON	ON	ON	7
OFF	ON	OFF	OFF	OFF	8
OFF	ON	OFF	OFF	ON	9
OFF	ON	OFF	ON	OFF	10
OFF	ON	OFF	ON	ON	11
OFF	ON	ON	OFF	OFF	12
OFF	ON	ON	OFF	ON	13
OFF	ON	ON	ON	OFF	14
OFF	ON	ON	ON	ON	15
ON	OFF	OFF	OFF	OFF	16
ON	OFF	OFF	OFF	ON	17
ON	OFF	OFF	ON	OFF	18
ON	OFF	OFF	ON	ON	19
ON	OFF	ON	OFF	OFF	20
ON	OFF	ON	OFF	ON	21
ON	OFF	ON	ON	OFF	22
ON	OFF	ON	ON	ON	23
ON	ON	OFF	OFF	OFF	24
ON	ON	OFF	OFF	ON	25
ON	ON	OFF	ON	OFF	26
ON	ON	OFF	ON	ON	27
ON	ON	ON	OFF	OFF	28
ON	ON	ON	OFF	ON	29
ON	ON	ON	ON	OFF	30
ON	ON	ON	ON	ON	31

Die Adressen einer einzelnen Schnittstelle können auf unterschiedliche Weise gewählt werden. Wenn innerhalb eines Aggregats mehrere Schnittstellen vorhanden sind, müssen auch die Adressen unterschiedlich sein.

### WERKEINSTELLUNG:

Batterieladeaggregat : **A**

Abschlusswiderstand CAN : **DEAKTIVIERT**

Adresse KTB4 : **0**



## BETRIEB DER SCHNITTSTELLE KTB4

Bevor die Schnittstelle ans Stromnetz angeschlossen wird, ist sicherzustellen, dass der Dip-Switch korrekt konfiguriert ist. Nachdem die Schnittstelle angeschlossen wurde, leuchten alle LEDs zwei Sekunden lang auf. Wenn alle Anschlüsse korrekt sind, leuchtet der LED LINK für das angeschlossene Batterieladegerät auch weiterhin.

## GRAPHIKEN LADUNGSAusGLEICH

Im Folgenden sind die Graphiken für den Ladungsausgleich im Hinblick auf die Temperatur der Batterien abgebildet:

SPANNUNG BATTERIEN

[24V]	[12V]
30,00	15,00
29,80	14,90
29,60	14,80
29,40	14,70
29,20	14,60
29,00	14,50
28,80	14,40
28,60	14,30
28,40	14,20
28,20	14,10
28,00	14,00
27,80	13,90
27,60	13,80
27,40	13,70
27,20	13,60
27,00	13,50
26,80	13,40
26,60	13,30
26,40	13,20
26,20	13,10
26,00	13,00
25,80	12,90
25,60	12,80
25,40	12,70
25,20	12,60
25,00	12,50

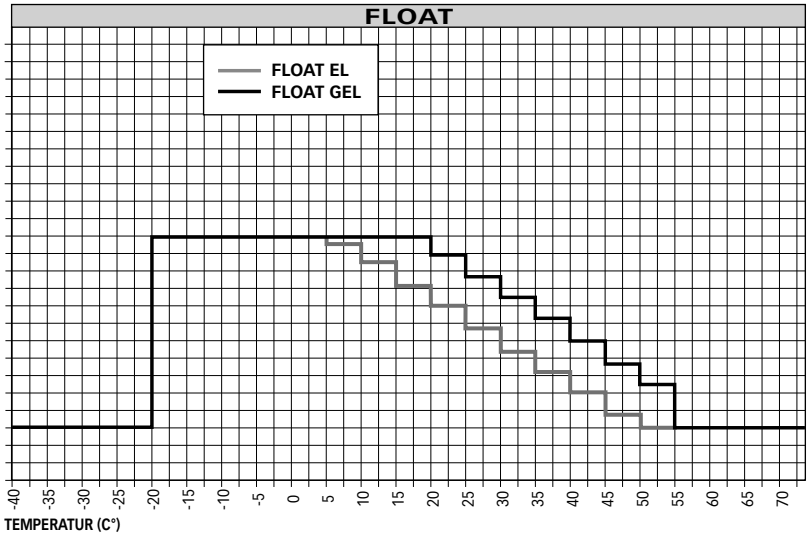

SPANNUNG BATTERIEN

[24V]	[12V]
30,00	15,00
29,80	14,90
29,60	14,80
29,40	14,70
29,20	14,60
29,00	14,50
28,80	14,40
28,60	14,30
28,40	14,20
28,20	14,10
28,00	14,00
27,80	13,90
27,60	13,80
27,40	13,70
27,20	13,60
27,00	13,50
26,80	13,40
26,60	13,30
26,40	13,20
26,20	13,10
26,00	13,00
25,80	12,90
25,60	12,80
25,40	12,70
25,20	12,60
25,00	12,50

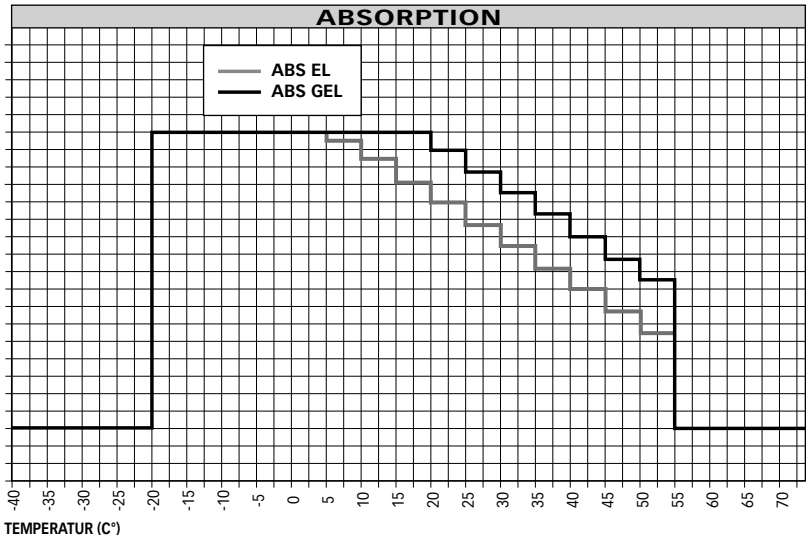



## BEDIENUNGS DISPLAY

Das Überwachungspaneel der Schnittstelle KTB4 umfasst 7 LEDs:

3 gelbe LEDs (LINK1, LINK2, LINK3) und 4 grüne LEDs (SENS1, SENS2, SENS3, SENS4).

Die LEDs LINK können folgenden Status haben:

ZUSTAND LED	BESCHREIBUNG
Aus	Die Schnittstelle ist ausgeschaltet.
Immer an	Verbindung vorhanden.
Die LED blinkt langsam	Keine Verbindung vorhanden. Falls das Batterieladegerät ausgeschaltet ist oder innerhalb des Aggregats nicht vorhanden ist, ist diese Anzeige korrekt. Wenn das Batterieladegerät angeschaltet ist, überprüfen Sie, ob das Datenübertragungskabel angeschlossen ist, sowie die Konfiguration des Aggregats und den CAN-Abschluss.
Die LED blinkt schnell	Falsche Konfiguration des Dip-Switch.

Die LEDs SENS können folgenden Status haben:

ZUSTAND LED	BESCHREIBUNG
Aus	Kein Sensor angeschlossen.
Immer an	Die gemessene Temperatur der Batterien liegt im Messbereich von -40° C / +120° C.
Die LED blinkt	Die gemessene Temperatur der Batterien liegt außerhalb des Messbereichs von -40°C +120°C. Falls der Sensor einen Kurzschluss hat oder geöffnet ist, erscheint auf dem Display des Batterieladegeräts die Anzeige "F".

## TECHNISCHE DATEN

<b>MODELL</b>	<b>KTB4</b>
---------------	-------------

### EINGANGSEIGENSCHAFTEN

Versorgungsspannung <sup>(1)</sup>	von 8 bis 30 Vdc
Max. Aufnahme	60 mA

### RAUMEIGENSCHAFTEN

Betriebstemperatur	von -20 bis + 70° C
--------------------	---------------------

### GEHÄUSE

Abmessungen (L x H x T)	134 mm x 63 mm x 94 mm
Gewicht	180 g
Kommunikations-Schnittstelle	CAN BUS mit Differential-Transceiver
EMV - Klassifizierung	EN 55022-B

<sup>(1)</sup> Das Gerät kann sich mit einer unter 8 Vdc liegenden Speisespannung zurückstellen.



## KTB4

La intercara a 4 canales KTB4 efectúa la compensación de carga de las baterías conectadas a los cargadores de baterías de la serie SBC ADV PLUS medium y high power.

Otras ventajas importantes que puede ofrecer el KTB4 son:

- Posibilidad de medir la temperatura de una, dos, tres o cuatro baterías (en base al número de sensores conectados).
- Posibilidad de conectar hasta 32 intercara KTB4 al mismo cargador de baterías.
- Alimentación universal (12/24Vdc).
- Intercara CAN BUS para el transferimiento de datos.
- Facilidad de instalación.

## INSTALACIÓN



**PRIMERO DE UTILIZAR LA INTERCARA, LEER CON ATENCIÓN EL PRESENTE MANUAL DEL USUARIO. EN CASO DE DUDAS CONTACTAR EL REVENDEDOR O EL SERVICIO DE CLIENTES QUICK®.**



En caso de discordancias o eventuales errores entre el texto traducido y el texto original en italiano, remitirse al texto en italiano o en inglés.



Este dispositivo ha sido diseñado y realizado para ser utilizado en embarcaciones de recreo. No se permite ningún uso diferente sin autorización escrita por parte de la sociedad Quick®.

El instrumento KTB4 ha sido proyectado para las funciones descritas en este manual del usuario. La sociedad Quick® no se asume ninguna responsabilidad por daños directos o indirectos causados por un uso impropio del aparato, por una equivocada instalación o por posibles errores presentes en este manual.

**EL DAÑO DEL INSTRUMENTO POR PARTE DE PERSONAL NO AUTORIZADO HACE DECAER LA GARANTÍA.**

**LA CONFECCIÓN CONTIENE:** intercara KTB4 - sensor KTBS - cable de conexión - condiciones de garantía - el presente manual del usuario.

## INSTALACIÓN DEL INSTRUMENTO

En seguida será descrito un procedimiento de instalación típico. No es posible describir un procedimiento que se pueda aplicar a todas las situaciones.

Adaptar este procedimiento para satisfacer los propios requisitos.

- La intercara tiene que ser posicionada en modo que el usuario lo pueda leer con comodidad.
- Escoger una posición que sea limpia, lisa y plana.
- Poner particular atención cuando se efectúan los agujeros en la superficie donde se fijará la intercara KTB4. Estos agujeros no tienen que debilitar o causar rupturas a la estructura de la embarcación.

La intercara responde a el standard EMC (compatibilidad electromagnética) pero se exige una correcta instalación para no comprometer las propias prestaciones y las de los instrumentos que están cerca. Por este motivo el instrumento tiene que estar lejos por lo menos:

- 25 cm del compás.
- 50 cm de cualquier aparato radio-receptor.
- 1 m de cualquier aparato radio-transmisor (excluido SSB).
- 2 m de cualquier aparato radio-transmisor SSB.
- 2 m del recorrido del haz del radar.



## CONEXIÓN ELÉCTRICA

La intercara responde a el estándar EMC (compatibilidad electromagnética) pero se exige una correcta instalación para no comprometer las propias prestaciones y las de los instrumentos que están cerca.

Por este motivo la intercara tiene que estar lejos por lo menos:

- 1 m de cables que transportan señales de radio (excluido de radio-transmisor SSB).
- 2 m de cables que transportan señales radio de radio-transmisor SSB.

Seguir las reglas que están en seguida para la realizar la instalación eléctrica relacionada con el instrumento:

- Alimentar el instrumento solo después de haber realizado y verificado la exactitud de todas las conexiones eléctricas.
- Montar un interruptor para prender y apagar la intercara.
- Montar un fusible rápido de 100 mA en la línea de alimentación de la intercara.
- Utilizar como conexión de la intercara de datos (señales CANH y CANL) un cable que no sea esgrimado con una pareja trenzada (sección 0.25/ 0.35 mm<sup>2</sup> AWG 22/24, impedancia 100/150 ohm).
- El sensor KTBS no tiene polaridad, por eso los cables pueden ser conectados en cualquier orden.
- La longitud máxima del cable no tiene que ser mayor de 100 metros.

Atrás de la intercara son presentes dos regletas de conexión para las conexiones de las señales eléctricas:

### REGLETA M1

SEÑAL	DESCRIPCIÓN
+ V SUPPLY (+)	Positivo alimentación instrumento
- V SUPPLY (-)	Negativo alimentación instrumento
CANH (H)	Intercara CAN
CANL (L)	Intercara CAN

### REGLETA M2

SEÑALES	DESCRIPCIÓN
SENS1	Sensor KTBS 1
SENS2	Sensor KTBS 2
SENS3	Sensor KTBS 3
SENS4	Sensor KTBS 4



## ESQUEMA TÍPICO DE CONEXIÓN

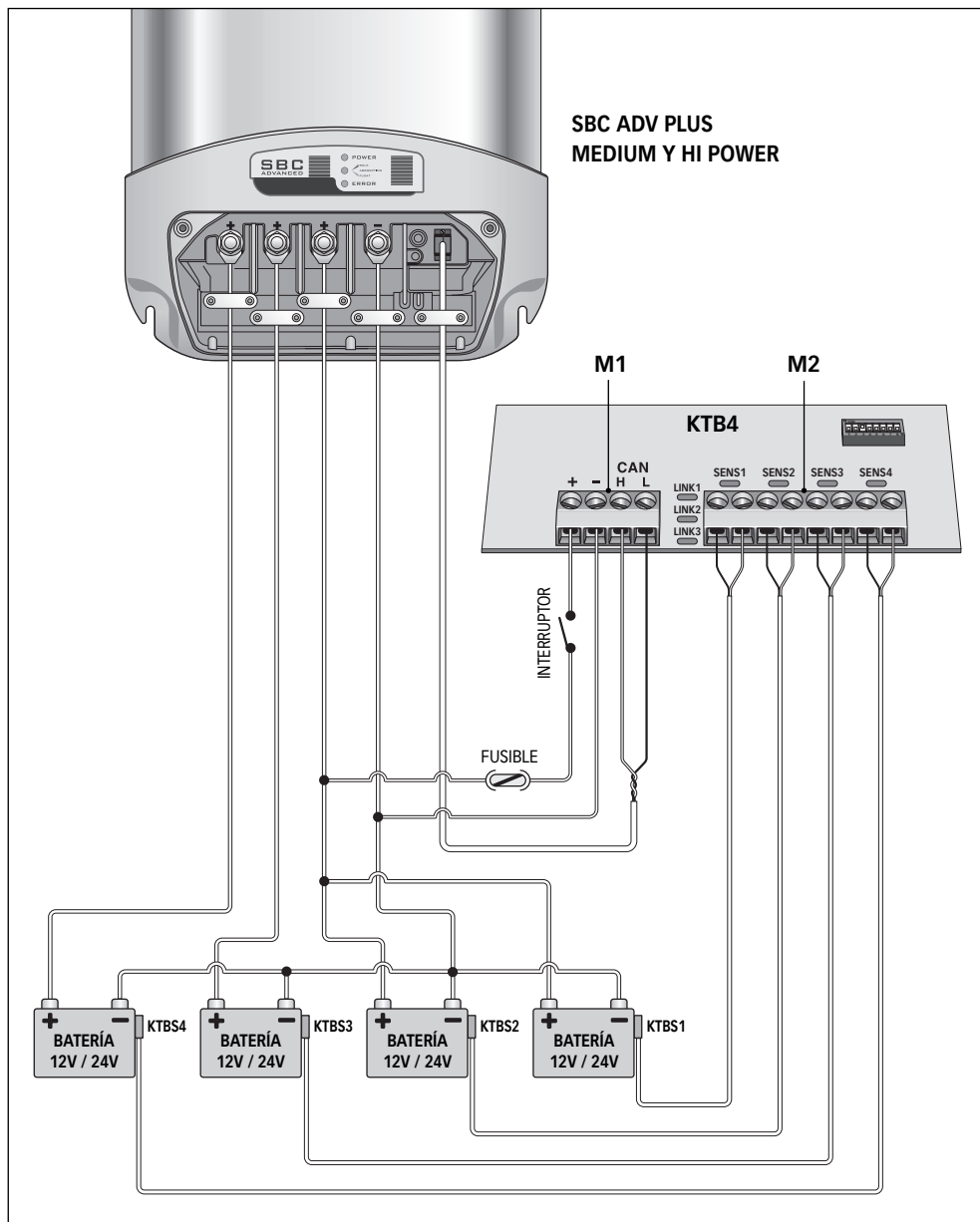



## INSTALACIÓN DEL SENSOR DE TEMPERATURA KTBS

- Limpiar cuidadosamente la superficie de la batería donde se pegará el KTBS.
- Remover la película de protección del adhesivo.
- Pegar el KTBS en la superficie de la batería haciendo presión por 30 segundos.

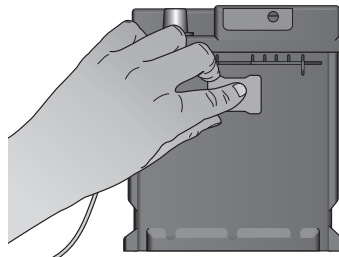
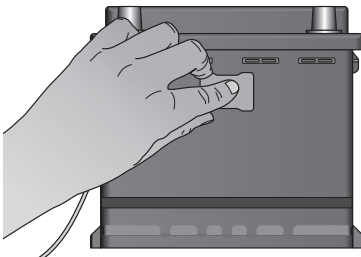
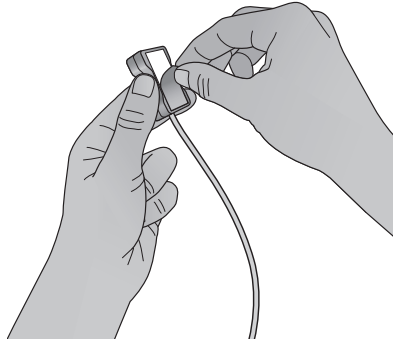
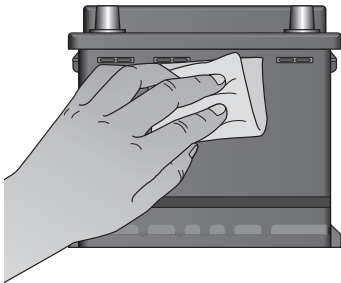

- El KTBS no tiene que ser pegado en las siguientes posiciones:

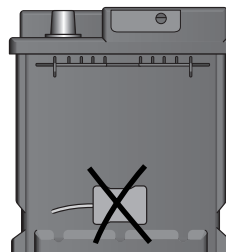
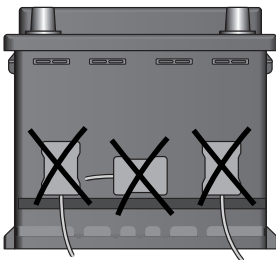

**ATENCIÓN:** No se aconseja de pegar el KTBS en la batería si la temperatura de la superficie de la batería es inferior a 10°C. La completa adhesión del KTBS se tendrá después de 72 horas de haberlo pegado.



### ACTIVACIÓN DE LOS TERMINALES

Activar la terminación en el primero y en el último dispositivo conectado en la red.

Para activar la terminación sobre el instrumento, ver fig. 1 y el parágrafo CONFIGURACIÓN DE LA INTERCARA.

En seguida se muestra un ejemplo de conexión de la red:

FIG. 1

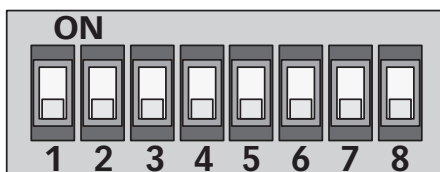

DIP-SWITCH

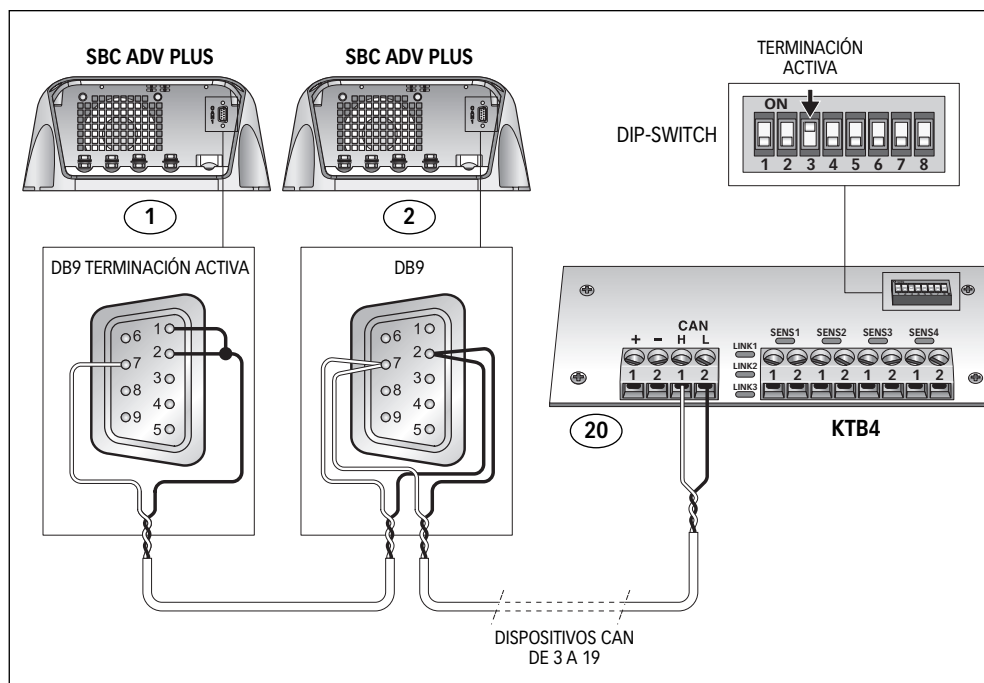





## CONFIGURACIÓN DE LA INTERCARA

La impostación de la intercara sucede trámite un dip-switch. Para configurar el grupo del cargador de baterías al cual se quieren enviar las temperaturas de las baterías, la terminación CAN y la dirección de identificación de la intercara KTB4, referirse al los tableros que se muestran en seguida:

SWITCH 1	SWITCH 2	FUNCIÓN	DESCRIPCIÓN
OFF	OFF	GRUPO A	
OFF	ON	GRUPO B	
ON	OFF	GRUPO C	

SWITCH 3	FUNCIÓN	DESCRIPCIÓN
OFF	TERMINAL CAN DESACTIVADO	
ON	TERMINAL CAN ACTIVADO	

SWITCH 4	SWITCH 5	SWITCH 6	SWITCH 7	SWITCH 8	DIRECCIÓN KTB4
OFF	OFF	OFF	OFF	OFF	0
OFF	OFF	OFF	OFF	ON	1
OFF	OFF	OFF	ON	OFF	2
OFF	OFF	OFF	ON	ON	3
OFF	OFF	ON	OFF	OFF	4
OFF	OFF	ON	OFF	ON	5
OFF	OFF	ON	ON	OFF	6
OFF	OFF	ON	ON	ON	7
OFF	ON	OFF	OFF	OFF	8
OFF	ON	OFF	OFF	ON	9
OFF	ON	OFF	ON	OFF	10
OFF	ON	OFF	ON	ON	11
OFF	ON	ON	OFF	OFF	12
OFF	ON	ON	OFF	ON	13
OFF	ON	ON	ON	OFF	14
OFF	ON	ON	ON	ON	15
ON	OFF	OFF	OFF	OFF	16
ON	OFF	OFF	OFF	ON	17
ON	OFF	OFF	ON	OFF	18
ON	OFF	OFF	ON	ON	19
ON	OFF	ON	OFF	OFF	20
ON	OFF	ON	OFF	ON	21
ON	OFF	ON	ON	OFF	22
ON	OFF	ON	ON	ON	23
ON	ON	OFF	OFF	OFF	24
ON	ON	OFF	OFF	ON	25
ON	ON	OFF	ON	OFF	26
ON	ON	OFF	ON	ON	27
ON	ON	ON	OFF	OFF	28
ON	ON	ON	OFF	ON	29
ON	ON	ON	ON	OFF	30
ON	ON	ON	ON	ON	31

Las direcciones de una sola intercara pueden ser escogidas en manera indiferente. Si al interno del mismo grupo están presentes más intercaras, las direcciones tienen que ser diferentes.

**CONFIGURACIÓN DE FABRICA:** Grupo cargador baterías : A  
Terminal CAN : **DESACTIVADO**  
Dirección KTB4 : 0



## FUNCIONAMIENTO DE LA INTERCARA KTB4

Primero de alimentar la intercara asegurarse que la configuración del dip-switch sea correcta. Después de haber conectado la alimentación a la intercara, todos los led se encienden por dos segundos. Si las conexiones se han hecho en manera correcta, el led LINK relacionado al cargador de baterías conectado se quedará siempre prendido.

## GRAFICOS DE COMPENSACIÓN DE CARGA

En seguida se muestran los graficos de compensación de carga en función de la temperatura de las baterías:

### TENSIÓN BATERÍAS

[24V]	[12V]
30,00	15,00
29,80	14,90
29,60	14,80
29,40	14,70
29,20	14,60
29,00	14,50
28,80	14,40
28,60	14,30
28,40	14,20
28,20	14,10
28,00	14,00
27,80	13,90
27,60	13,80
27,40	13,70
27,20	13,60
27,00	13,50
26,80	13,40
26,60	13,30
26,40	13,20
26,20	13,10
26,00	13,00
25,80	12,90
25,60	12,80
25,40	12,70
25,20	12,60
25,00	12,50

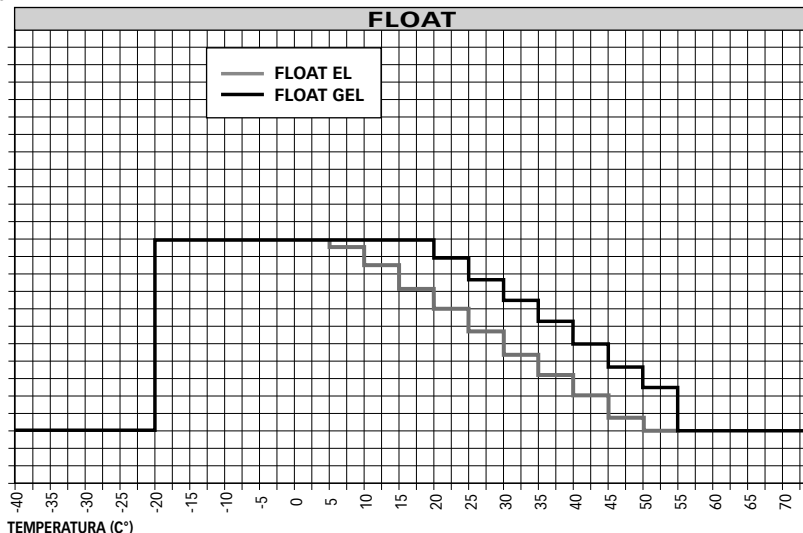

### TENSIÓN BATERÍAS

[24V]	[12V]
30,00	15,00
29,80	14,90
29,60	14,80
29,40	14,70
29,20	14,60
29,00	14,50
28,80	14,40
28,60	14,30
28,40	14,20
28,20	14,10
28,00	14,00
27,80	13,90
27,60	13,80
27,40	13,70
27,20	13,60
27,00	13,50
26,80	13,40
26,60	13,30
26,40	13,20
26,20	13,10
26,00	13,00
25,80	12,90
25,60	12,80
25,40	12,70
25,20	12,60
25,00	12,50

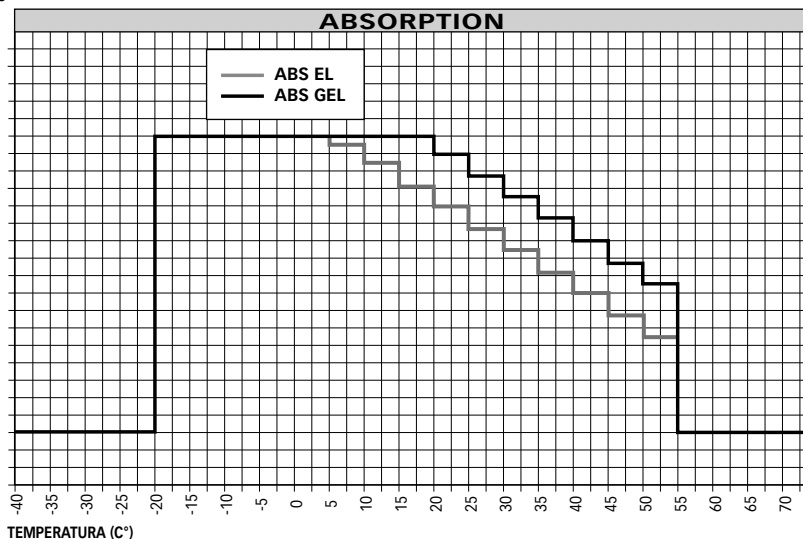



## TABLERO DE CONTROL

El panel de control de la intercara KTB4, está compuesto por 7 led:  
3 led amarillos (LINK1, LINK2, LINK3) y 4 led verdes (SENS1, SENS2, SENS3, SENS4).

Los led LINK pueden asumir el siguiente estado:

ESTADO LED	DESCRIPCIÓN
Apagado	La intercara está apagada.
Siempre prendido	Conexión presente.
El led relampaguea lentamente	La conexión no está presente. Si el cargador de baterías está apagado o no está presente al interno del grupo, esta señalación es correcta. Si el cargador de baterías está prendido, verificar la conexión del cable de transmisión de datos, la configuración, el grupo y la terminación CAN.
El led relampaguea velozmente	Configuración del dip-switch equivocada.

Los led SENS pueden asumir el siguiente estado:

ESTADO LED	DESCRIPCIÓN
Apagado	No está conectado ningún sensor.
Siempre prendido	La temperatura del las baterías medida está en el intervalo $-40^{\circ}\text{C} / +120^{\circ}\text{C}$ .
El led relampaguea	La temperatura de las baterías medida está afuera del intervalo de medida $-40^{\circ}\text{C} / +120^{\circ}\text{C}$ . Si el sensor está en corto o está abierto sobre el display del cargador de baterías se visualiza la "F".

## CARACTERÍSTICAS TÉCNICAS

<b>MODELO</b>	<b>KTB4</b>
---------------	-------------

### CARACTERÍSTICAS DE ENTRADA

Tensión de alimentación <sup>(1)</sup>	de 8 a 30 Vdc
Absorbimiento máximo	60 mA

### CARACTERÍSTICAS AMBIENTALES

Temperatura operativa	de $-20$ a $+70^{\circ}\text{C}$
-----------------------	----------------------------------

### GENERALES

Medidas (L x A x P)	134 mm x 63 mm x 94 mm
Peso	180 g
Intercara de comunicación	CAN BUS con transceiver diferencial
Clase EMC	EN 55022-B

<sup>(1)</sup> El instrumento puede resetearse con una tensión de alimentación inferior a los 8 Vdc.

# KTB4 - DIMENSIONI (mm)



DIMENSIONS - DIMENSIONS - ABMESSUNGEN - DIMENSIONES

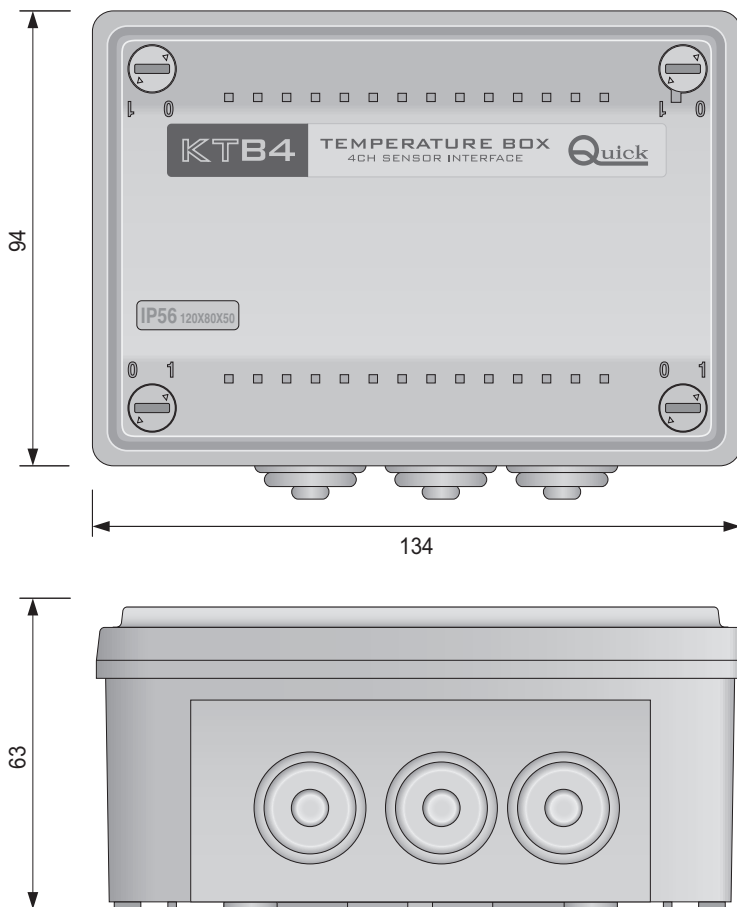







# KTB4

## TEMPERATURE BOX 4CH SENSOR INTERFACE

R002A

- IT** Codice e numero seriale del prodotto
- GB** Product code and serial number
- FR** Code et numéro de série du produit
- DE** Code- und Seriennummer des Produkts
- ES** Código y número de serie del producto