



SEAKEEPER

OPERATION MANUAL



****THIS MANUAL ALSO COVERS THE SEAKEEPER 7HD MODEL****

 SEAKEEPER	OPERATION MANUAL	Product:	Document #:	Rev:
		SEAKEEPER 9 / 7HD	90223	6

SEAKEEPER 9 / 7HD OPERATION MANUAL JANUARY 2017

Contents:

Section 1 – System Overview

Section 2 – System Operation

Section 3 – Power Failures, Alarms, and Troubleshooting

Section 4 – Maintenance

Section 5 – Warranty, Limit of Liability, Property Rights

Section 6 – Specs and Summary



44425 PECAN COURT, SUITE 151

CALIFORNIA, MARYLAND, 20619, U.S.A

PHONE: 410-326-1590

FAX: 410-326-1199

E-MAIL: customerservice@seakeeper.com

Section 1: SYSTEM OVERVIEW

1.0 System Overview

The Seakeeper 9 uses gyroscopic principles to reduce boat roll motions in waves and wakes independent of boat speed. In multiple Seakeeper installations, the Seakeepers operate independently of each other and therefore this manual only discusses operation of a single unit.

A Seakeeper 9 consists of a Gyro assembly, a CAN communications cable, and a Display. Figure 1 illustrates the interconnection of these components and their interface with the boat.

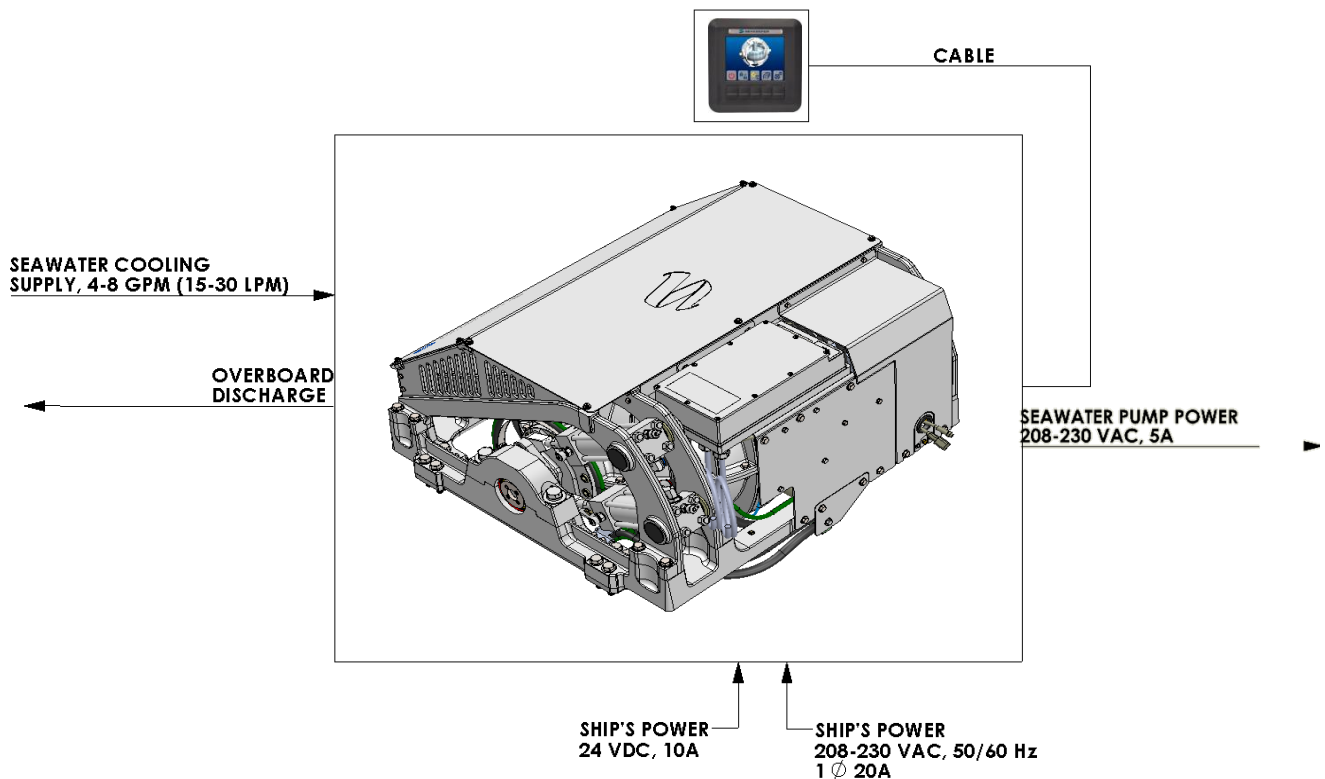

FIGURE 1 – SEAKEEPER 9 STABILIZATION SYSTEM COMPONENTS

Technical specifications provided in Section 6 list the power consumption, total weight, and dimensions of the major components. Gyroscopic principals that apply to boat roll control are discussed on Seakeeper’s web site at www.seakeeper.com. The Seakeeper web site also contains videos of Seakeeper operation and videos of several different boats operating in waves with the Seakeeper on and off. It is recommended that the reader play these videos prior to reading the remainder of this manual.

Section 1: SYSTEM OVERVIEW

The gimbal angle and the rate of rotation about the gimbal axis (termed precession rate) play an important role in its operation. These parameters are illustrated in Figure 2. At zero degree gimbal angle, the sphere is vertical; it can precess a maximum of +/- 70 degrees about this position. The amount of torque that the Seakeeper exerts on a boat's hull to counter the wave induced roll is directly proportional to the precession rate. The further the Seakeeper is from vertical (zero degrees) the lower the anti-roll torque. The vertical arrows in Figure 2 illustrate the direction of the forces that the Seakeeper exerts on the boat's hull to damp roll motion.

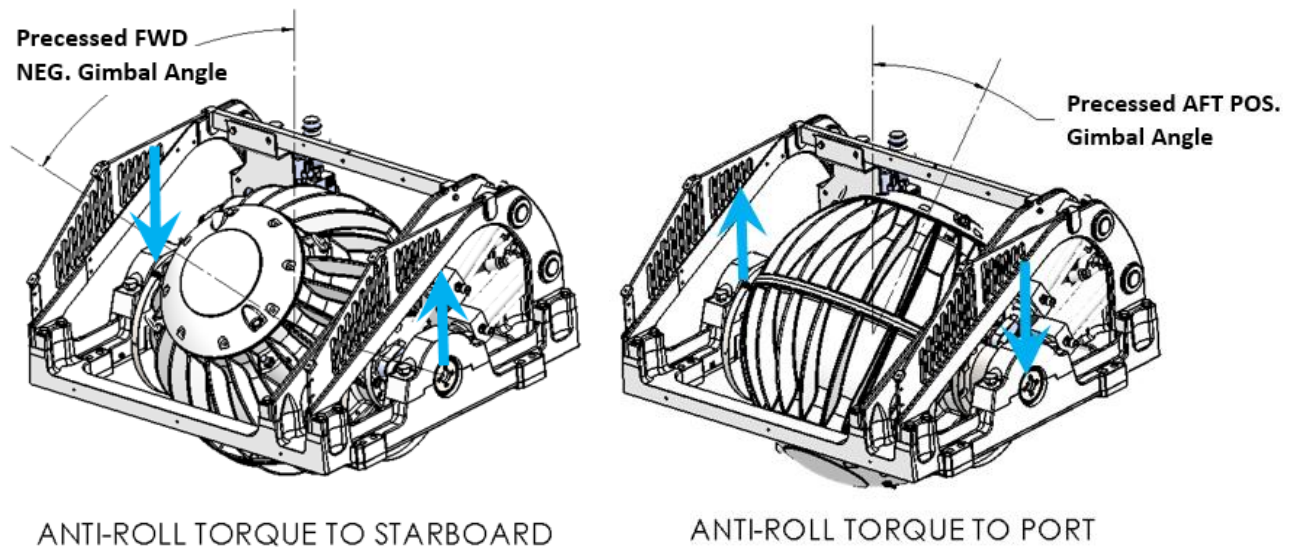

FIGURE 2 – SEAKEEPER PRECESSION

Seakeeper precession is actively controlled by an electronic controller and a hydraulic brake throughout each roll cycle so the Seakeeper supplies the maximum anti-roll torque and does not make mechanical contact with hard stops that limit the maximum gimbal angle travel to +/- 70°.

Section 1: SYSTEM OVERVIEW

There is a large torque about the gimbal axis when the Seakeeper is precessing. Seakeeper cover panels are provided to prevent personnel or equipment from contacting the Seakeeper while it is in operation. These covers should not be stood on, or have anything placed on top. The covers should always be in place during operation. If it is ever necessary to touch the Seakeeper while the flywheel is spinning, the Seakeeper must be locked at the display to stop the Seakeeper from precessing. Seakeeper maintenance should not be attempted unless the Seakeeper is locked and the flywheel has stopped spinning.

Section 1: SYSTEM OVERVIEW

1.1 Seakeeper Assembly

The Seakeeper assembly consists of a flywheel housed in a cast aluminum vacuum-tight enclosure. The flywheel spins about a vertical axis and is supported by upper and lower pairs of bearings. A DC brushless motor mounted inside the enclosure spins the flywheel at high speed.

The enclosure is fastened to two gimbal shafts that are supported by gimbal bearings on either side. These shafts establish an athwartship gimbal axis about which the flywheel and enclosure precess or rotate up to +/- 70 degrees during operation. The gimbal bearings are supported by a foundation which is attached to the hull structure. This foundation transfers the loads that the Seakeeper produces to the hull structure.

An active hydraulic brake mechanism is located on the Seakeeper assembly to regulate the Seakeeper's precession motions about the gimbal shaft. It includes two hydraulic cylinders and a hydraulic manifold.

A coolant pump, heat exchanger with reservoir, and thermostat are located near the manifold. A glycol/water mix is circulated thru a closed loop to the motor drive box, hydraulic manifold, and the end caps of the enclosure to remove heat.

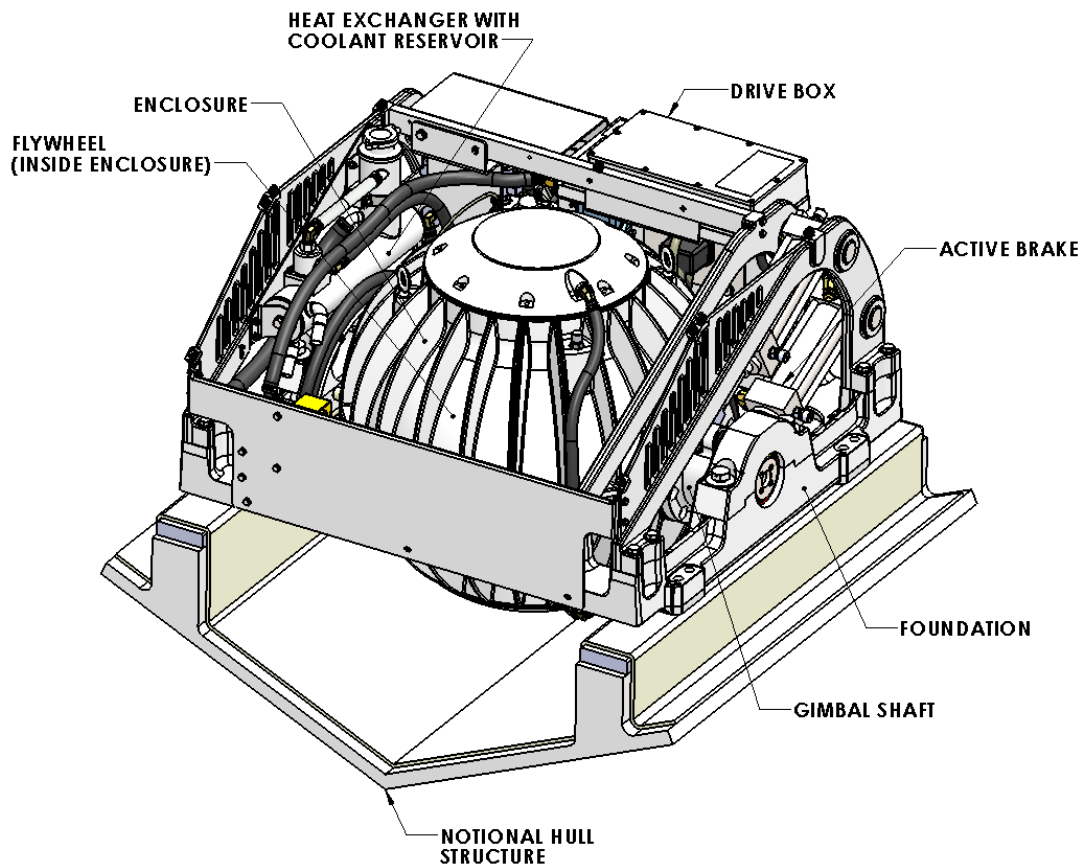

FIGURE 3 – SEAKEEPER ASSEMBLY

Section 1: SYSTEM OVERVIEW

1.2 Display

The display shown below is the user interface to the Seakeeper 9 and should be mounted at the primary helm station. It is used to start, operate, monitor and shutdown the Seakeeper. Sensors, alarms and shutdowns are provided to allow unattended operation. However the Seakeeper is a high-speed machine and special attention should be paid to abnormal vibration and noise as this could be the first hint of a mechanical problem.

The display provides information in the event of an alarm. Alarms cause precession to stop (LOCK) and the Seakeeper to start coasting down (STOP).



FIGURE 4 – OPERATOR DISPLAY

Section 1: SYSTEM OVERVIEW

1.3 Drive Box

The glycol/water mix that cools the Seakeeper is also circulated through a cold plate inside the Drive Box to remove heat from high-power electronic components.



The Motor Drive Box contains hazardous voltage and the cover should not be removed while the flywheel is spinning and the AC input voltage is present. This high voltage exists even if the flywheel is coasting down and the supply voltage has been shut off. The flywheel must be at Zero (0000) RPM and AC input power disconnected for at least 10 minutes prior to any service work on the motor drive box.

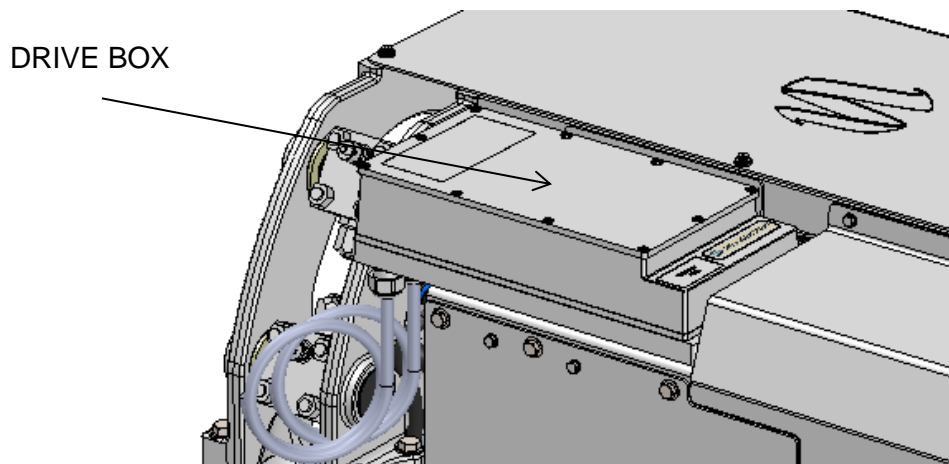

FIGURE 5 – DRIVE BOX

1.4 Electronic Control Module

The Electronic Control Module (ECM) monitors all the system sensors and automatically regulates operation of the Seakeeper.

The controller commands the motor speed and regulates the Seakeeper's precession rate and gimbals angle. This is accomplished by commands to a high response flow control valve in the hydraulic brake circuit that increases or decreases the brake pressure.

Section 1: SYSTEM OVERVIEW

1.5 Inertia Measurement Unit (IMU)

The motion sensor suite in the IMU measures the angular movements of the vessel and the vertical and lateral boat movement. These signals are communicated to the ECM through the Seakeeper's wiring harness.

1.6 Brake

The brake mechanism consists of two hydraulic cylinders that attach to a crank arm on the Seakeeper gimbal shaft. The Seakeeper controller modulates how fast the oil can flow through a control valve thus controlling the precession rate of the Seakeeper.

The brake hydraulic circuit is a pre-charged closed loop – that is, there is no pump, motor or reservoir in the circuit. Accumulators are installed in the circuit so the pre-charge pressure does not increase as the fluid temperature rises due to the braking action. Locking solenoids are installed in the circuit to lock the Seakeeper so it cannot precess if there is a leak in the circuit or a mechanical problem with the Seakeeper.

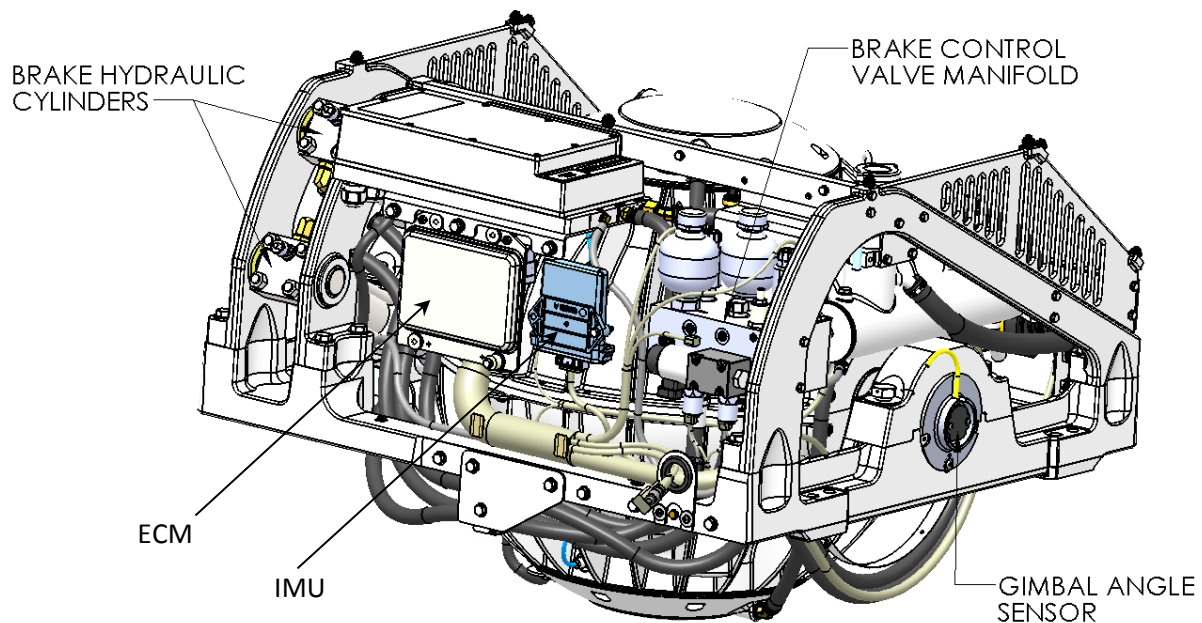

FIGURE 6 – BRAKE SYSTEM COMPONENTS

Hydraulic Hand Pump Kit, P/N 10384, is required for servicing the brake system. Pressure should never be relieved unless this tool is available.

Section 1: SYSTEM OVERVIEW

1.7 Cooling

The cooling circuit is a closed loop that supplies a glycol/water (50% distilled water and 50% glycol) mix to:

- The motor drive box to remove heat from the drive electronics
- The brake manifold to remove heat from the brake hydraulic circuit
- The enclosure water jackets to remove heat from the flywheel bearings

The heated fluid then passes through a thermostat before bypassing or flowing through a heat exchanger that has sea water on the cold side. The circuit also contains a coolant reservoir for coolant expansion and to make filling easy. The reservoir contains a 7 psi (0.5 bar) pressure cap. The heat exchanger contains zinc anodes that must be inspected and changed regularly to ensure maximum heat exchanger life.

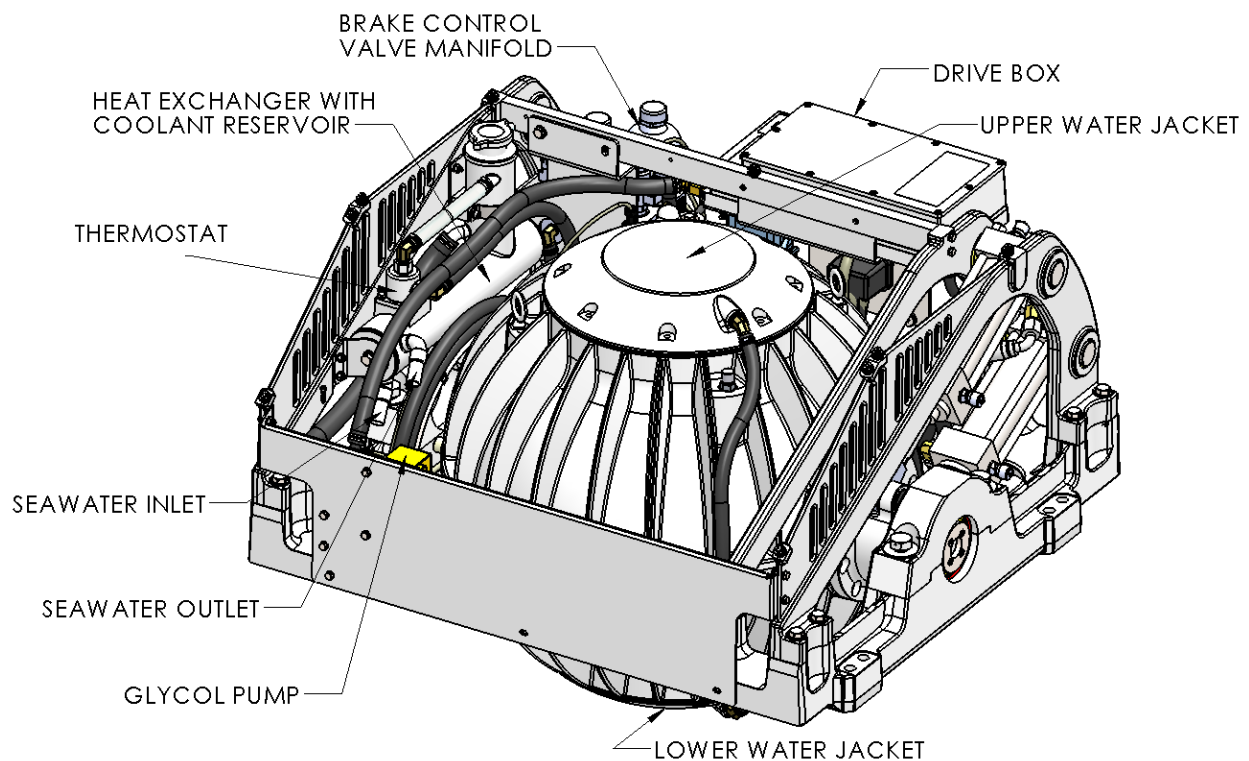

FIGURE 7 – COOLING SYSTEM COMPONENTS

Section 2: SYSTEM OPERATION

2.0 Introduction

This section describes operation of the Seakeeper 9 system.

2.1 Display Screens: Overview

- 1) When 24 VDC is applied to the Seakeeper the DISPLAY will power up and initialize. The SPLASH screen will be displayed



- 2) After the DISPLAY has initialized the HOME screen will be displayed



- 3) The DISPLAY has a set of five buttons that are under the BUTTON ICONS that appear on the display screen. The BUTTONS are the means for selecting the functions of the DISPLAY.







Section 2: SYSTEM OPERATION



a. HOME Screen BUTTON function

- i.  Seakeeper ON/OFF and FAULT RESET
 1. The ICON will change from red (Seakeeper OFF) to green (Seakeeper ON)
 2. The ICON will turn red indicating the SEAKEEPER is off when a fault appears
 3. When a FAULT occurs the BUTTON is used to reset the active fault

- ii.  SEAKEEPER LOCK/UNLOCK
 1. When the Seakeeper control is initializing, or the Seakeeper is off, the lock symbols will both be blue
 2. When the Seakeeper is in LOCK mode, stabilization is off, and the LOCK symbol will be red 
 3. When the Seakeeper is UNLOCKED, stabilization is on, and the UNLOCK symbol will be green 

- iii.  DISPLAY DAY/NIGHT
 1. Toggles the DISPLAY brightness between the Day and Night settings

Section 2: SYSTEM OPERATION

iv.  HOME SCREEN VIEW

1. Switches the HOME screen views from an animation screen, to a screen displaying arrows with no animation, to a screen that shows roll rate on a graph



Home Screen with Animation: Flywheel will be spinning and Seakeeper stabilizing



Home Screen with Arrows for flywheel spinning and stabilizing



Home Screen indicating Roll Rate

v.  SETTINGS SCREEN

1. Changes from the HOME screen to the SETTINGS screen

- 4) When the button is depressed for the SETTINGS screen  the DISPLAY changes to the SETTINGS screen





a. SETTINGS screen BUTTON ICON functions

- i.  Allows the brightness of the DISPLAY to be increased or decreased. The brightness settings for the DAY or NIGHT modes can be independently adjusted by selecting the DAY or NIGHT on the main page before entering the SETTINGS screen.

Section 2: SYSTEM OPERATION

1. When the button is depressed the BRIGHTNESS settings appears





2. The BRIGHTNESS is decreased or increased by depressing the MINUS button  or the PLUS button 

3. To navigate back to the SETTINGS screen the BACK button is depressed 

- ii.  Adjusts the sleep function of the DISPLAY from one minute to 30 minutes or the DISPLAY screen on all of the time

1. When the button is depressed the DISPLAY SLEEP TIMER setting appears



2. The SLEEP TIME is decreased or increased by depressing the MINUS button  or the PLUS button 

3. To return back to the SETTINGS screen the BACK button is depressed 

- iii.  Changes to the speed mode screen. See section 2.5 Boat Transit and Speed set point selection screen for more information.

- iv.  Changes the DISPLAY to the SERVICE screen



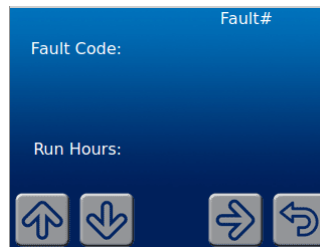

- v.  Returns the DISPLAY to the HOME screen

Section 2: SYSTEM OPERATION

- 5) When the button  is depressed for the SERVICE screen the DISPLAY changes to the SERVICE screen. The SERVICE screen displays the FAULT history of the Seakeeper



a. SERVICE screen BUTTON ICON functions

- i. To scroll through the ALARM history the UP button  and DOWN button  are depressed
- ii. To change to the Seakeeper information screen the NEXT button is depressed 
- iii. To change back to the SETTINGS screen the BACK button is depressed 
- 6) The Seakeeper information screen displays the Seakeeper model, Seakeeper serial number, Seakeeper software version, DISPLAY software version, RUN hours, and SEA hours, the IMU software version as well as the Motor Drive software version. Seakeeper Service personnel may access this screen to gather additional service functions.

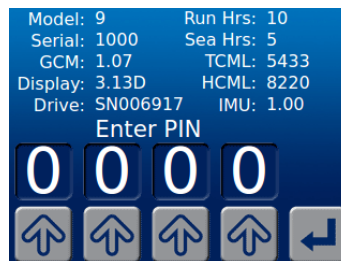

Seakeeper 9 pictured above

- a. The RETURN button  will return the DISPLAY to the SERVICE screen

Section 2: SYSTEM OPERATION

2.2 Start-up

- 1) Make sure AC and DC power are available.
- 2) Turn on the boat's DC circuit breaker that supplies power to the Seakeeper.
- 3) Turn on the boat's AC circuit breaker that supplies power to the Seakeeper.
- 4) In most cases, the seawater pump will be wired to turn on when the Seakeeper is turned on. However, in some cases the seawater pump is on a separate AC or DC circuit breaker and it is necessary to turn it on.
- 5) When the DC power is turned on the DISPLAY will initialize and the HOME screen will appear. If a FAULT is present an ALARM screen will appear.



To turn the Seakeeper ON depress the POWER ON/OFF FAULT RESET button, the button will turn GREEN, the flywheel will spin (or arrow appear), and a RED PROGRESS BAR will appear. The PROGRESS BAR indicates how soon the Seakeeper will be available for stabilization. When the Seakeeper is initialized and when the Seakeeper is up to minimum operating speed the PROGRESS BAR will turn from RED to GREEN. At this point, the Seakeeper is available for stabilization.



Section 2: SYSTEM OPERATION

- 6) When the Seakeeper reaches its maximum operating speed where maximum stabilization is available, the PROGRESS BAR will disappear and the Seakeeper is available for maximum stabilization.



2.3 Stabilization

For stabilization after Seakeeper is ON and at speed:

- 1) Press the LOCK/UNLOCK button. The button will turn GREEN indicating that the Seakeeper is precessing and stabilizing the roll motion. The stabilization mode starts gradually; it takes 5-10 seconds to reach full effectiveness.



Section 2: SYSTEM OPERATION

If it is necessary to shutoff power to the flywheel motor and slow the flywheel for any reason, press Seakeeper ON/OFF button; the button will turn RED and the LOCK/UNLOCK button will turn RED indicating the command has been accepted. It takes approximately 4+ hours for the speed to drop to zero rpm.



If it is necessary to stop Seakeeper motion for any reason press the LOCK/UNLOCK button. The LOCK symbol will turn RED indicating that the Seakeeper is locked. Never attempt to work on the Seakeeper until the flywheel has stopped spinning. In the event that the brake system has automatically locked the Seakeeper due to an alarm or failure, no attempt should be made to bypass the alarm or automatic lock.

Section 2: SYSTEM OPERATION

2.4 Normal Shut-Down

The Seakeeper should be stopped when stabilization is no longer required. Once the vessel is secured, the AC and DC breakers can be switched OFF. The Seakeeper will continue to spool down to zero rpm. No cooling is required during this time.

Note: The seawater pump may run for 5 minutes after the Seakeeper is switched off and is coasting (with AC power applied).

- 1) Verify that no alarms are on the Seakeeper display.
- 2) Press LOCK/UNLOCK button. The LOCK symbol will turn RED



- 3) Press Seakeeper ON/OFF button. The ON/OFF symbol will turn RED. The Seakeeper will start coasting.

When the flywheel has stopped spinning 0 RPM will appear on the screen



- 4) Once the vessel is secured in the slip and the crew has shut down the generator and engines, switch the AC and DC breakers that control the Seakeeper OFF. The flywheel will continue to spool down to zero rpm. This can take 4+ hours from full speed.

Section 2: SYSTEM OPERATION

The Seakeeper should be stopped when stabilization is no longer required. Once the vessel is secured in the slip and the crew has shut down the generator and engines, the AC and DC breakers that control the Seakeeper should be switched to the OFF position. The Seakeeper will continue to spool down to zero rpm. No cooling is required during this time. Note Seakeeper will take 4+ hours to coast down to zero rpm from full speed.



Note: The seawater pump may run for 5 minutes after the Seakeeper is switched off and is coasting (with AC power applied).

Section 2: SYSTEM OPERATION

2.5 Boat Transit and Speed Adjustment





When cruising without Seakeeper stabilization, run the Seakeeper at 1000 rpm to maintain lubrication of the bearings. The Seakeeper will use less than 300 watts of AC power while operating in this mode.

- 1) Press the SETTINGS button  to move from the MAIN screen to the SETTINGS screen
- 2) Press the SPEED ADJUST button  to adjust the Seakeeper's speed.





Section 2: SYSTEM OPERATION

- 3) To scroll through the SPEED settings, press the UP button  and DOWN button  to highlight another speed.



Seakeeper 9 pictured above

- 4) Press the SET button  to select the highlighted Seakeeper speed. The selected speed will turn yellow. 1000 RPM is used for boat transit without stabilization.
- Seakeeper 9:** Normal operational speed is 9000 RPM. Quiet mode operates at 7200 RPM, which allows stabilization at a reduced flywheel speed. When 24V power is removed from the Seakeeper, the speed selection will revert to 9000 RPM.
 - Seakeeper 7HD:** Normal operational speed is 7000 RPM. Quiet mode operates at 5600 RPM, which allows stabilization at a reduced flywheel speed. When 24V power is removed from the Seakeeper, the speed selection will revert to 7000 RPM.

- 5) To navigate back to the SETTINGS screen, the BACK button is depressed 

- 6) Make sure AC power is available to the Seakeeper and use the  Seakeeper ON/OFF to turn the Seakeeper ON if it is not already on.
- The ICON will change from red (SEAKEEPER OFF) to green (SEAKEEPER ON)

Section 3: POWER FAILURES, ALARMS, AND TROUBLESHOOTING

3.0 Power Failures

There are two sources of power to the Seakeeper 9:

- 24 Volts DC powers the Seakeeper for all the control electronics.
- 208 - 230 Volts AC powers the Motor Drive Box to drive the motor inside the Seakeeper.

These are supplied on Cables 1 and 2 which are shown on Seakeeper drawing 90257, Cable Block Diagram.



The Motor Drive Box contains hazardous voltage and the cover should not be removed while the flywheel is spinning and the AC input voltage is present. This high voltage exists even if the flywheel is coasting down and the supply voltage has been shut off. The flywheel must be at Zero (0000) RPM and AC input power disconnected for at least 10 minutes prior to any service work on the motor drive box.

3.1 24 VDC Failure

The display will be blank. Flywheel speed will decrease. The brake is locked (no precession).

- Verify the boat's circuit breaker supplying +24 VDC has not tripped and the AC breaker is On.

When +24 VDC is restored, the display will be powered up, Splash Screen will appear, and then Home Screen will appear.

- Press POWER ON/OFF 

The progress bar will appear and indicate flywheel speed. When the flywheel is at minimum operating speed the progress bar will turn green and brake system may be unlocked. This may take up to 15 minutes, depending on the speed of the flywheel when +24 VDC is turned back on.

Section 3: POWER FAILURES, ALARMS, AND TROUBLESHOOTING

3.2 230 VAC Failure

If the AC power is not connected, a notification screen will indicate “AC Mains Low”. If the failure is not corrected within two minutes, an “AC Mains Low” alarm will occur. The brake will lock.

- Verify the boat’s circuit breaker supplying 208-230 VAC to the Motor Drive Box has not tripped.

Once 208-230 VAC is restored:

- Press POWER ON/OFF  to clear the alarm. Then press the POWER ON/OFF button again to continue Seakeeper operation.
- The progress bar will appear and indicate flywheel speed. When the flywheel is at minimum operating speed the progress bar will turn green and gyro brake system may be unlocked. This may take up to 15 minutes, depending on the speed of the flywheel when VAC is turned back on.

3.3 230 VAC Fluctuation, Spike or Momentary Failure

If the AC voltage to the Motor Drive Box is outside Seakeeper’s specified range (208 – 230 VAC), the Motor Drive Box will briefly shut down for protection. The Motor Drive Box will continue operation when the voltage returns to the specified range.

A brief fluctuation can happen when the generator is unable to regulate its output voltage, particularly when a large AC load is switched on or off. A momentary AC failure also happens during transition from shore power to ship’s power.

3.4 Alarms

The Seakeeper issues an alarm when it detects a malfunction that could cause damage or erratic operation. When an alarm occurs, the Seakeeper will stop and an alarm message is shown on the Display.

The alarm will not clear until the operator presses the POWER ON/OFF button and the alarm condition is no longer present. The operator can then press the POWER ON/OFF button again to continue Seakeeper operation.

Section 3: POWER FAILURES, ALARMS, AND TROUBLESHOOTING

- A view of a typical ALARM screen.

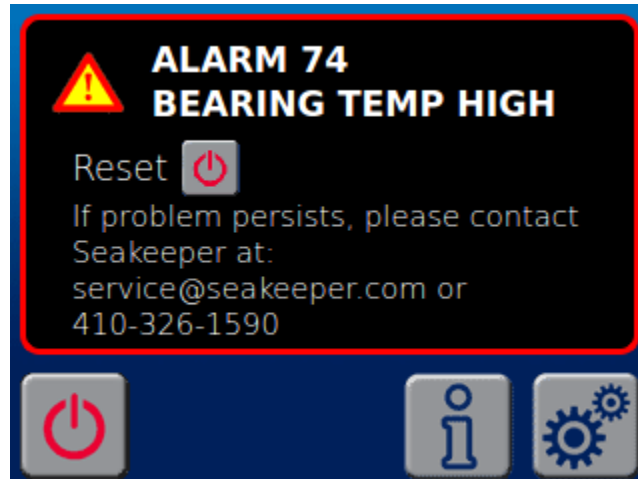

- If the ALARM appears and there is an INFORMATION button  on the screen the ALARM has more information associated with it. By depressing the INFORMATION button the INFORMATION screen will appear.

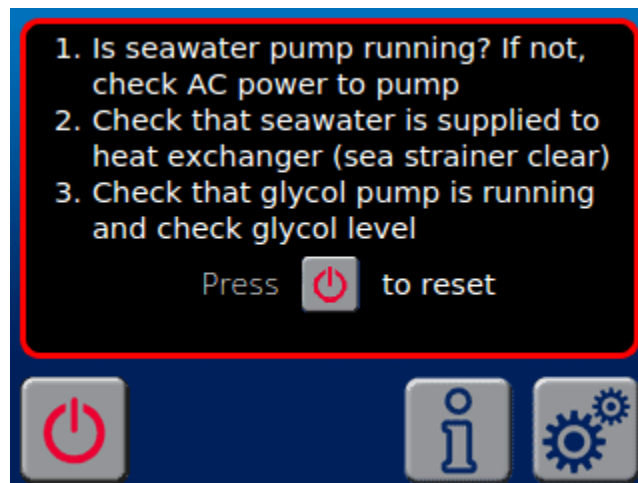



- To reset the ALARM utilize the Seakeeper ON/OFF button 

Section 3: POWER FAILURES, ALARMS, AND TROUBLESHOOTING

3.5 Alarm and Warning History

The Service page on the Display shows the recent alarms and warnings. The alarms and warnings are in chronological order starting with the most recent. Warnings are for issues that do not affect gyro operation.

- From the Home Screen at the Display, go to SETTINGS screen by depressing the SETTINGS screen key  and then go to the SERVICE screen by depressing the SERVICE screen key 
- View the ALARMS and WARNINGS in the history by pressing UP and DOWN arrow keys.



Section 4: MAINTENANCE

4.0 MAINTENANCE

The Seakeeper system is designed to require as little maintenance as possible. However, since the system is comprised of mechanical and electrical components that operate in a marine environment, some periodic inspections and maintenance are required. Seakeeper recommends a regular inspection interval and Scheduled Maintenance to keep the Seakeeper running trouble-free.

If the Seakeeper is installed in a wet space, efforts should be made to keep the Seakeeper free of salt residue from either condensation or direct exposure to salt spray. If exposed, a regular wipe down with mild soap and water with a rinse will help limit corrosion and keep the Seakeeper assembly in good cosmetic condition. Refer to Service Bulletin 90106 for details.

If any components of the Seakeeper or its sub-systems will be exposed to environmental temperatures where winterization is necessary for storage, reference Seakeeper service bulletin 90405.

The Seakeeper comes standard with sealant and thread locker on applicable fasteners. When reinstalling all fasteners use thread locker and sealant unless otherwise specified.

4.1 REFERENCES

- Seakeeper 90025, Service Bulletin, Brake Bleeding
- Seakeeper 90026, Service Bulletin, Seakeeper Paint Information
- Seakeeper 90083, Service Bulletin, Gimbal Angle Sensor Replacement and Calibration
- Seakeeper 90106, Service Bulletin, Fresh Water Rinse Notice
- Seakeeper 90317, Service Bulletin, 12 Month 1000 Hr Scheduled Maintenance
- Seakeeper 90405, Service Bulletin, Seakeeper Winterization Process

4.2 PRECAUTIONS



- **Hydraulic Hand Pump Kit, Part No. 10384, is required for servicing the brake. Pressure should NOT be relieved unless this tool is available.**

4.3 PARTS AND SPECIAL TOOLS

Part No.	Description	Comments
10384	Hydraulic Hand Pump Kit	Required for all brake service tasks.
10449	Brake Bushing Replacement Tool Kit	Contains tools used for changing bushings

Section 4: MAINTENANCE

4.4 SCHEDULED MAINTENANCE TABLE

- The following pages contain the scheduled maintenance table organized by systems: Mechanical, Hydraulic, Cooling, and Electrical. Scheduled maintenance is not covered under warranty.

SYSTEM / COMPONENT	TASK	INTERVAL	PARTS / SPECIAL TOOLS
Mechanical / Corrosion	Inspect unit for severely corroded areas and clean and touch up with paint. See Service Bulletin 90026.	12 Months or 1000 Hours	Awlgrip Paint Part Numbers: Primer: S9001 Primer Converter: S3001 Top Coat, Snow White: F8063 Top Coat Converter: G3010
Hydraulic / Hoses	Check for cracks or chafing. If chafing found, reposition hose to provide clearance around hose. If chafing is severe, replace hose. Charge system per Service Bulletin 90025.	12 Months or 1000 Hours	Hydraulic hand pump kit
Cooling / Zinc Anode	Replace zinc anode as needed. Note the wear rate after each check and adjust inspection interval accordingly.	3 Months or 150 Hours	Replacement Zincs are available from Seakeeper.
Cooling / Hoses	Check for cracks or chafing. If damaged, replace hose. Fill cooling system and purge air.	12 Months or 1000 Hours	Anti-freeze – 50/50 Ethylene Glycol mix.
Cooling / Seawater side	Inspect heat exchanger for signs of leaks.	3 Months or 150 Hours	
Cooling / Seawater side	Fill with environmentally safe, marine anti-freeze during winter or periods of in-operation.	Winter	
Electrical / Connectors	Inspect all connectors for corrosion, replace if necessary.	12 Months or 1000 Hours	
Electrical / Grounds	Inspect all ground points for corrosion, clean as necessary, and treat with corrosion inhibitor.	12 Months or 1000 Hours	
Electrical / Gimbal Angle Sensor	Check calibration of sensor. See Service Bulletin 90083 for instructions.	Only if Angle Alarms occur	
Electrical / Cables	Check all cables and wire harness branches for cracks or chafing. Take special attention to gimbal shaft areas.	12 Months or 1000 Hours	
Electrical / Power Input	Check for seal at cable glands.	12 Months or 1000 Hours	
Electrical / Motor Power	Check integrity of motor power cable jacket.	12 Months or 1000 Hours	

Section 4: MAINTENANCE

SYSTEM / COMPONENT	TASK	INTERVAL	PARTS / SPECIAL TOOLS
Mechanical / Hydraulic Brake	Replace brake bushings, hydraulic accumulators and check valves	Inspect at 12 Months or 1000 Hours – Replace as needed or at 2000 Hours	Hydraulic hand pump kit, Brake bushing replacement tool kit, Hydraulic brake parts kit
Mechanical / Hydraulic Brake	Flush Hydraulic Oil	12 Months or 1000 Hours	Hydraulic Hand Pump Kit Oil: AW46
Cooling / System	Cooling system flush	12 Months or 1000 Hours	Fill reservoir, antifreeze – 50/50 Ethylene Glycol mix

Section 5: WARRANTY

5.0 WARRANTY, LIMITATION OF LIABILITY, PROPERTY RIGHTS

5.1 WARRANTY

The complete Seakeeper warranty details may be found on the Seakeeper website www.seakeeper.com

Seakeeper Standard Models:

Seakeeper warrants that the Goods sold hereunder are free from defects in material and workmanship. This warranty is for the following period, whichever occurs first:

- a. 36 months from the date of shipment from SEAKEEPER factory
- b. 24 months from date the product put into service, which shall conclusively be presumed to be the date of sale of a vessel, on which a SEAKEEPER product is installed, to a retail customer or date put into service on an existing vessel (refit).
- c. Or, 2000 (two thousand) hours of use, subject to verification and confirmation by SEAKEEPER, INC.

Seakeeper Heavy Duty Models:

Seakeeper warrants that the Goods sold hereunder are free from defects in material and workmanship. This warranty is for the following period, whichever occurs first:

MAJOR COMPONENTS (SPHERE):

- a. 48 months (4 years) from date the product put into service, which shall conclusively be presumed to be the date of sale of a vessel, on which a SEAKEEPER, INC., product is installed, to a retail customer or date put into service on an existing vessel (refit).
- b. Or, 4000 (Four thousand) operating SEA hours, subject to verification and confirmation by SEAKEEPER, INC.,

ALL OTHER COMPONENTS

- a. 24 months (2 years) from date the product put into service, which shall conclusively be presumed to be the date of sale of a vessel, on which a SEAKEEPER, INC., product is installed, to a retail customer or date put into service on an existing vessel (refit).
- b. Or, 2000 (two thousand) hours of use, subject to verification and confirmation by SEAKEEPER, INC.,

Section 5: WARRANTY**All Seakeeper models:**

This warranty does not cover normal wear of the following components or the costs associated with maintenance, repair or replacement:

- a. Surface Corrosion (Cosmetic) on any component due to exposure
- b. Heat exchanger
- c. Zinc Anodes
- d. Brake Bushings
- e. Isolation Bushings
- f. Normal preventive and scheduled maintenance and component inspections/replacements as specified in the SEAKEEPER, INC., Operation Manuals and any other Maintenance Schedule documentation.

This express warranty is in lieu of and excludes: ALL OTHER WARRANTIES, EXPRESSED OR IMPLIED, BY OPERATION OF LAW OR OTHERWISE INCLUDING WARRANTIES OF MERCHANTABILITY OR FITNESS FOR A PARTICULAR PURPOSE (WHETHER KNOWN TO SELLER OR NOT), AND ALL OTHER SUCH WARRANTIES ARE HEREBY EXPRESSLY DISCLAIMED BY SELLER AND WAIVED BY CUSTOMER/END USER. SEAKEEPER, INC. SHALL IN NO EVENT BE LIABLE TO ANY SPECIAL, DIRECT, INDIRECT, INCIDENTAL OR CONSEQUENTIAL DAMAGES FOR BREACH OF ANY WARRANTY OR OTHER OBLIGATION ARISING OUT OF THE SALE OF THE PRODUCTS, OR FROM THE USE OF THE PRODUCTS OR ANY INABILITY TO USE THE PRODUCTS.

Written notice of claimed defects shall have been given to Seakeeper within the Warranty Period, and within thirty (30) days from the date any such defect is first discovered. The Goods or parts claimed to be defective must be returned to Seakeeper, accompanied by a Return Authorization (RA) issued by Seakeeper's facility responsible for supplying Goods, with transportation prepaid by Buyer/User, with written specifications of the claimed defect.

If a warranty claim is valid, SEAKEEPER, INC. will repair or replace the Product, or part of the Product, proven to be defective, at its sole discretion, in a timeframe provided by SEAKEEPER, INC., on a reasonable best effort basis.

Under no circumstances shall Seakeeper be liable for removal of Seakeeper's Goods from Buyer's/User's equipment or re-installation into Buyer's/User's equipment. No person including any agent, distributor, or representative of Seakeeper is authorized to make any representation or warranty on behalf of Seakeeper concerning any Goods manufactured by Seakeeper.

Section 5: WARRANTY

5.2 LIMITATION OF LIABILITY

NOTWITHSTANDING ANYTHING TO THE CONTRARY, SEAKEEPER SHALL NOT BE LIABLE FOR ANY SPECIAL, INCIDENTAL, INDIRECT OR CONSEQUENTIAL DAMAGES INCLUDING BUT NOT LIMITED TO LOST PROFITS ARISING OUT OF THE PERFORMANCE, DELAYED PERFORMANCE OR BREACH OF PERFORMANCE OF THIS ORDER REGARDLESS WHETHER SUCH LIABILITY BE CLAIMED IN CONTRACT, EQUITY, TORT OR OTHERWISE. SEAKEEPER'S OBLIGATION IS LIMITED SOLELY TO REPAIRING OR REPLACING (AT ITS OPTION AND AS SET FORTH IN SECTION 5), AT ITS APPROVED REPAIR FACILITY, ANY GOODS OR PARTS WHICH PROVE TO SEAKEEPER'S SATISFACTION TO BE DEFECTIVE AS A RESULT OF DEFECTIVE MATERIALS OR WORKMANSHIP, IN ACCORDANCE WITH SEAKEEPER'S STATED WARRANTY. IN NO EVENT SHALL SEAKEEPER'S LIABILITY EXCEED THE TOTAL PURCHASE PRICE SET FORTH IN THIS ORDER.

5.3 PROPERTY RIGHTS

Except where otherwise expressly agreed, all patterns, tools, jigs and fixtures, drawings, designs, software and other materials and data developed, fabricated by Seakeeper shall be and shall remain Seakeeper's property. Except as specifically provided for in the order, Buyer shall have no right in any technical data, Intellectual Property Rights, and computer software associated with the order. Buyer shall not use or permit the use of the Goods that in any way could result in the disclosure of Seakeeper's proprietary information.

Section 6: SEAKEEPER SPECIFICATIONS

Seakeeper 9 / 7HD Specifications & Summary

	Seakeeper 9	Seakeeper 7HD
Rated RPM	9,000 RPM	7,000 RPM
Angular Momentum at Rated RPM	9,000 N-M-S	7,000 N-M-S
Anti-Rolling Torque at Rated RPM	18,810 N-M	14,630 N-M
Spool-up Time to Rated Speed	55 minutes (9,000 RPM)	35 minutes (7,000 RPM)
Spool-up Time to Stabilization	38 minutes (7,650 RPM)	25 minutes (5,600 RPM)
Spool-up Power		
AC Motor	3,000 Watts Max	3,000 Watts Max
DC Motor	240 Watts	240 Watts
Operating Power		
AC Motor (Sea state dependent)	1,000-2,000 Watts	1,000-2,000 Watts
DC Control	240 Watts	240 Watts
Voltage		
AC Input	208-230 VAC ($\pm 10\%$), 50/60 Hz, Single Phase	208-230 VAC ($\pm 10\%$), 50/60 Hz, Single Phase
DC Input	24 VDC @ 10 Amps	24 VDC @ 10 Amps
Sea Water Supply to Heat Exchanger	30 LPM (8 GPM) maximum 15 LPM (4 GPM) minimum	30 LPM (8 GPM) maximum 15 LPM (4 GPM) minimum
Ambient Air Temperature	0° - 60°C (32° - 140°F)	0° - 60°C (32° - 140°F)
Weight	550 kg. (1,210 lbs) bolt-in	550 kg. (1,210 lbs) bolt-in
Envelope Dimensions	0.85 L x 0.90 W x 0.72 H (meters) 33.5 L x 35.6 W x 28.3 H (inches)	0.85 L x 0.90 W x 0.72 H (meters) 33.5 L x 35.6 W x 28.3 H (inches)
Noise Output	At full operating RPM, steady state noise measured in the factory at a 1 meter distance measures 68-70 dBC (sound levels may be higher during spool-up).	At full operating RPM, steady state noise measured in the factory at a 1 meter distance measures 68-70 dBC (sound levels may be higher during spool-up).



Section 6: SEAKEEPER SPECIFICATIONS**Arrangement**

The Seakeeper 9 consists of the Flywheel, Enclosure, Foundation, Electronics, Brake, Cooling, and Cover Subsystems.

Installation Location

The Seakeeper is a torque device and does not have to be installed in a specific hull location or on the centerline. However, the Seakeeper should not be installed forward of the longitudinal center of gravity in a planing vessel.

Mounting Dimensions

See Seakeeper Drawing 90225 for bolt-in installation details.
See Seakeeper Drawing 90226 for bond-in installation details.

Loads

The installer is responsible for designing the foundation to which the Seakeeper is attached and for ensuring that this foundation can safely transfer the concentrated Seakeeper loads from the frame to the adjacent hull structure. Loads that the Seakeeper imposes on the hull structure are explained on Seakeeper Drawings 90225 and 90226; these loads do NOT include vessel motion accelerations, such as vertical slam loads which can be high for higher speed vessels.

Cooling

The Seakeeper bearings, Motor Drive Box, and hydraulic manifold are cooled by a closed water / glycol mix cooling loop that incorporates a sea water heat exchanger. The installer is responsible for providing 15 – 30 lpm (4 – 8 gpm) raw water at ambient sea temperature and 1.4 Bar (20 psi) maximum pressure to the heat exchanger.

Section 6: SEAKEEPER SPECIFICATIONS**Electrical**

The installer is responsible for supplying 208-230 VAC, 50/60 Hz, single phase power on a 20A service to the Motor Drive Box and 24 VDC @ 10A service to the Seakeeper Control System. Separate circuit breakers should be used for each Motor Drive Box in multiple Seakeeper installations. Similarly, separate circuit breakers should be used for each Seakeeper Control System in multiple Seakeeper installations.

Operator Controls

A Display with integrated Keypad is used to start, operate, monitor, and shutdown the Seakeeper.

Performance

Reduction of boat roll is a function of the boat's displacement, transverse metacentric height (GM_T) and hull damping as well as the operating conditions (speed and heading with respect to waves) and sea state. The Seakeeper controller regulates the active hydraulic brake to ensure the Seakeeper's anti-roll torque is maximized irrespective of hull characteristics or operating conditions.

Alarm and Monitoring

Sensors, alarms and shutdowns are provided to allow unattended operation. Sensors measure Seakeeper and drive temperatures, vacuum pressure, gimbal angle, brake pressure, and ship motion. The Seakeeper controller sends sensor values and alarm information to the display and also locks the brake and shuts down the motor drive in the event of an alarm condition. Seakeeper operating history during faults or alarms is recorded in the controller's memory for subsequent recall if service is needed. Seakeeper may access the Seakeeper's software to gather run hours, bearing loading, and hull slamming information.

Safety

The brake automatically locks the Seakeeper so it cannot generate excessive anti-rolling torque loads in the event of a system fault or alarm, loss of electrical power or loss of brake pressure. The brake can be locked from the Display or by shutting off AC and DC power at the supply breakers.