

# MASTERVOLT

THE POWER TO BE INDEPENDENT

## MLI Ultra

LITHIUM-ION BATTERY  
12/1250, 24/1250



### USER AND INSTALLATION MANUAL

- For the latest version of this manual, visit our website:
- Ga om deze handleiding in andere talen te downloaden naar onze website:
- Um diese Anleitung in anderen Sprachen herunterzuladen, besuchen Sie bitte unsere Website:
- Pour télécharger ce manuel dans d'autres langues, consultez notre site Web :
- Para descargar este manual en otros idiomas, visite nuestro sitio web:
- Per scaricare questo manuale in altre lingue, visitare la pagina del prodotto sul nostro sito Web:

[www.mastervolt.com](http://www.mastervolt.com)

In case of any discrepancy in the interpretation of different language versions, the English version shall prevail.

## Table of contents

1. SAFETY INSTRUCTIONS .....	3	History tab .....	17
Warnings and symbols .....	3	Configuration tab .....	17
Safety warnings.....	3	Events tab.....	19
Safety guidelines.....	5	Events sources .....	20
2. GENERAL INFORMATION .....	6	Event commands .....	21
Liability .....	6	Stop Charge event.....	21
Warranty .....	6	Configuration in a CZone network.....	22
Disclaimer .....	6	6. BUILDING A BATTERY BANK .....	24
Identification label .....	6	Series and parallel connections .....	24
Correct disposal of this product.....	6	Configuration of a battery bank .....	25
3. PRODUCT DESCRIPTION .....	7	Battery bank configuration with DIP	
Status LEDs .....	7	switches (MasterBus only) .....	25
Battery switch-button (safety disconnect)8		Battery bank configuration with	
Battery Management System (BMS) .....	9	MasterAdjust.....	27
Charging .....	9	Battery bank configuration with the	
4. BASIC INSTALLATION .....	10	CZone Configuration Tool.....	28
Unpacking .....	10	7. STORAGE AND CARE .....	29
Location .....	10	8. TROUBLESHOOTING.....	30
Materials needed.....	11	9. SPECIFICATIONS.....	32
Installation procedure for a single unit .	11	Technical specifications .....	32
Adding the MLI Ultra to a MasterBus		Battery switch – automatic behavior .....	33
network .....	12	Characteristics .....	34
Adding the MLI Ultra to a CZone			
network .....	13		
Auxiliary connector .....	14		
5. CONFIGURATION .....	15		
DIP switch settings.....	15		
MasterBus DIP switch settings .....	15		
CZone DIP switch settings .....	15		
How to change the DIP switch			
settings.....	16		
Configuration in a MasterBus network.	16		
Monitoring tab .....	16		
Alarms tab.....	17		

## 1. SAFETY INSTRUCTIONS

### IMPORTANT SAFETY INSTRUCTIONS

#### SAVE THESE INSTRUCTIONS

##### Warnings and symbols

Safety instructions and warnings are marked in this manual by the following pictograms:



#### **CAUTION!**

Special information, commands and prohibitions in order to prevent damage.



#### **WARNING!**

A **WARNING** refers to possible injury to the user or installer or significant material damage to the MLI Ultra if the installer / user does not (carefully) follow the stated procedures.

##### Safety warnings



#### **WARNING!**

The battery contains hazardous materials that are stored safely during normal use. Do not crush, open or drop the battery housing. Do not touch or ingest any of the released materials or inhale released gasses when accidental leakage of the battery occurs. Should skin contact, eye contact or inhalation nevertheless occur, take the necessary first aid measures immediately. Refer to the Material Safety Data Sheet for Mastervolt Lithium-Ion batteries, which is available on [www.mastervolt.com](http://www.mastervolt.com).



#### **WARNING!**

Avoid short circuiting batteries as this may result in fire, explosion, electric shock or release of toxic gas. Use insulated tools only and keep metal objects away from the battery. Do not wear watches, bracelets, necklaces or other metal objects when working on the battery. In case of fire, take the necessary

firefighting measures immediately. Refer to the Material Safety Data Sheet for Mastervolt Lithium-Ion batteries, which is available on [www.mastervolt.com](http://www.mastervolt.com).

**WARNING!**

Short circuits, too deep discharges and too high charge currents will damage the battery and may result in fire, explosion, electric shock or release of toxic gas. Never charge a battery:

- after it was discharged below the Battery Safety voltage;
- when the battery is damaged;
- when the battery was over-charged.

If in doubt, contact your Mastervolt dealer.

**CAUTION!**

When transported, make sure that:

- the battery is in its original package or equivalent;
- the battery is in upright position;
- soft slings are used to avoid damage;
- the battery is only lifted at the handles;
- the battery is handled with care.

**Note:** The voltage range (12.0-14.6V or 24.0-29.2V) is larger than you may expect from other battery types such as lead-acid batteries. Be aware that these voltages could exceed the permitted voltages of the connected load(s).

## Warning regarding life support applications

Mastervolt products are not designed to be used as component of medical equipment, unless negotiated in the form of a written agreement between customer and/or manufacturer and ASG. Such agreement will require the equipment manufacturer either to contract additional reliability testing of the Mastervolt parts and/or to commit to undertake such testing as a part of the manufacturing process. Furthermore, the manufacturer must agree to indemnify and not hold ASG responsible for any claims arising from the use of the Mastervolt parts in the life support equipment.

### Safety guidelines

- Use the MLI Ultra following the instructions and specifications stated in this manual.
- Work on the MLI Ultra should be carried out by qualified personnel only.
- Non-compliance with operating instructions, repairs made with other than original parts, or repairs made without authorization render the warranty.
- If programming of events in a MasterBus or CZone network is required, the installer must be familiar with the programming of such events.
- Connections and safety features must always comply with all local rules and regulations.
- Use cables with an appropriate size.
- Never use the MLI Ultra in situations where there is danger of gas or dust explosion or potentially flammable products!
- Only use the MLI Ultra in a technical correct condition.
- Only use the MLI Ultra in a well-ventilated area and protect the connectors from moisture and dust.
- Switch off all charging systems and disconnect the MLI Ultra from the electrical installation during maintenance and/or repair activities.

## 2. GENERAL INFORMATION

### Liability

ASG cannot be held liable for:

- Consequential damage resulting from the use of the MLI Ultra.
- Possible errors in the included manual and the consequences of these.
- Use that is inconsistent with the purpose of the MLI Ultra.

### Warranty

The Mastervolt product warranty covers the MLI Ultra for the first two years after the purchase date, on the condition that the product is installed and used according to the instructions in this manual. Installation or use that does not comply with these instructions may result in under performance, damage or failure of the product and may void this warranty. The warranty is limited to the cost of repair and/or replacement of the product. Costs of labor or shipping are not covered by this warranty.

### Disclaimer

Our products are subject to continual development and improvement. Therefore, additions or modifications to the products may cause changes to the technical data and functional specifications. No rights can be derived from this document. Please consult our online Terms & Conditions of Sale.

### Identification label

The following picture is only an example!



The identification label is located on the top side of the MLI Ultra. Technical information required for service and maintenance (part number, serial number and revision code) can be derived from the identification label.



### CAUTION!

Never remove the identification label.

This will void the warranty.

### Correct disposal of this product



This product is designed and manufactured with high quality materials and components, which can be recycled and reused. Act according to your local rules and do not dispose of your old products with your normal household waste. The correct disposal of your old product will help prevent potential negative consequences to the environment and human health.

### 3. PRODUCT DESCRIPTION

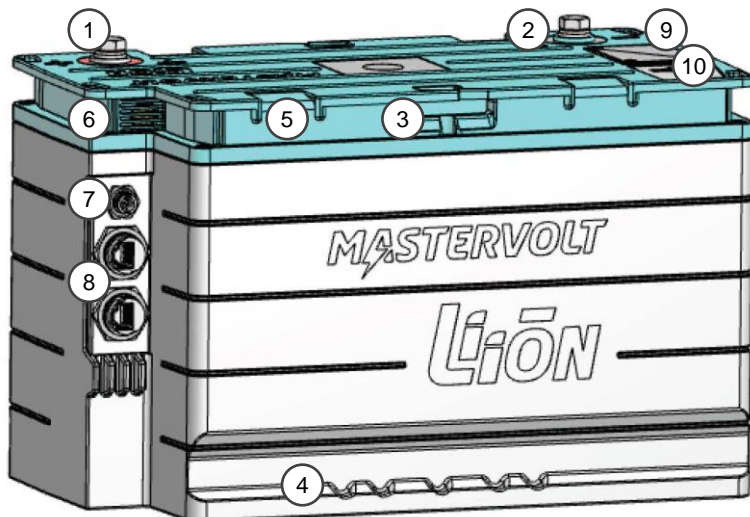

- |   |  |
|---|--|
| 1. M8 positive terminal   | 7. Auxiliary connector                                 |
| 2. M8 negative terminal   | 8. MasterBus/CZone connectors                          |
| 3. Provision for removable handle   | 9. Status LEDs and DIP switch cover                    |
| 4. Hold down edges group 31, fit battery group size 49  | 10. Battery switch-button ( <i>safety disconnect</i> ) |
| 5. Attachment strap support   |  |
| 6. Protective vent; maintain adequate ventilation around this opening. Do not touch the membrane! |  |

Figure 1: overview of the MLI Ultra 1250

#### Status LEDs

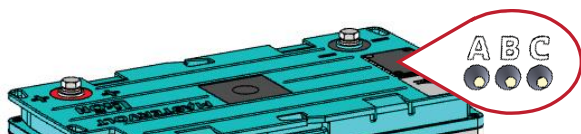

Figure 2: status LEDs

LED	Color	Name	Behavior	
A	Red	Error	If this LED is on, a BMS error has occurred or cells are damaged. Check the installation and contact your Mastervolt dealer.	
B	Yellow	Battery state	During normal operation the LED is off.	
			1 short blink ● ● ●	State of Charge (SoC) low. Charge the battery.
			2 short blinks ●● ●● ●●	CZone network identification (during installation).
			3 short blinks ●●● ●●●	Auto cluster configuration error. See section "Battery bank configuration with DIP switches" on page 25.
			4 short blinks ●●●● ●●●●	Battery is executing a recovery procedure.
			Blinking slowly — — —	Battery is updating its firmware.
C	Green	Battery switch state	When the Battery switch-button is pressed short, this LED indicates the status of the battery switch. - Solid on for 1 minute: battery is on (switch is closed). - Blinking for 1 minute: battery is off (switch is open).	

### Battery switch-button (safety disconnect)



#### CAUTION!

This built-in battery switch is to safely disconnect the battery. It also disconnects from the charger!

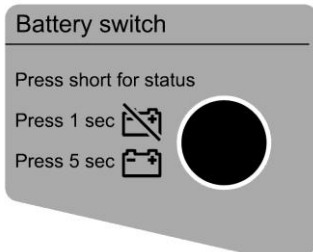

Figure 3: Battery switch-button

**Press short for status;** Short press to make LED C show the status of the Battery switch.

- Solid on for 1 minute: battery is on (switch is closed).
- Blinking for 1 minute: battery is off (switch is open).

**Press 1 sec;** Long press for 1 second to switch-off. LED C will blink.

**Press 5 sec;** Long press for 5 seconds to switch-on. LED C will light up for 1 minute.

**Note:** If the battery was switched-off manually, it must be switched-on manually.



## Battery Management System (BMS)

The MLI Ultra has a built-in Battery Management System (BMS) and a built-in battery switch. The BMS protects the battery by automatically controlling the battery switch when thresholds are met. This is called a 'battery safety'-event. See chapter "SPECIFICATIONS" for the thresholds. An automatically switch-off is initiated after the following events:

- Cell over- or under-voltage
- Battery over-current
- Over-temperature of the MLI Ultra
- Low State of Charge (SOC)

Likewise, automatically switch-on is initiated when the conditions are safe again.

## Charging

The MLI Ultra can be charged with any Mastervolt battery charger, like the ChargeMaster Plus series, or with a ProMariner ProSport HD or ProNautic for example. Make sure that the charger is Lithium Ion compatible and meets the MLI Ultra's charge parameters. Set the battery type to MLI or adjust the 3-step+ (also known as LuoUo) charge characteristic as follows:

Model	Bulk / absorption voltage	Float voltage
12V	14.25 V	13.5 V
24V	28.5 V	27 V

LED B will blink yellow when the state of charge (SOC) is low. Make sure to charge when the SOC is low to preserve the lifespan.

### Recovering from deeply discharge

If the MLI Ultra was deeply discharged, the integrated 1A charger charges the cells to 2.5V. After that, a self-test on the cells will activate automatically to test if the cells are damaged by the deep discharge. When the result is ok, the battery will be switched-on, and normal charging can start. When the result is not ok, LED A will be solid red. In that case, contact your Mastervolt dealer. Please note that this procedure may take between 30 minutes to 5 hours!

### Charging at low temperature

Do not use a sensor for temperature compensated charging. Temperatures of the battery and its cells are monitored by the built-in BMS. If the temperature of the MLI Ultra is below 0°C [32°F], an integrated heater is automatically turned on until 5°C [41°F] is reached or the charger is disconnected. This heater can also be controlled through MasterBus events or CZone circuits.

## 4. BASIC INSTALLATION

### Unpacking

The delivery consists of the following parts:

1. MLI Ultra battery with 2x M8 bolt + washer + spring washer, for screw connection
2. 1x automotive battery pole positive (thick) + M8 Allen bolt, for clamp connection
3. 1x automotive battery pole negative (thin) + M8 Allen bolt, for clamp connection
4. Handle
5. 2x Attachment strap (for stationary applications only)
6. MasterBus terminator
7. MasterBus cable (1m)
8. Drop cable CZone/MB (1m)
9. Auxiliary cable (2m)
10. The quick installation manual

Never use a damaged battery. If in doubt, contact your Mastervolt dealer.

### Location

- Install the MLI Ultra in a well-ventilated room protected against rain, snow, spray, vapor, bilge, moisture and dust.
- Keep the MLI Ultra away from heat sources. See specifications for allowed operating temperatures.
- The MLI Ultra must be installed in upright position or on the long side of the case, although upright mounting is recommended.



*Upright position*

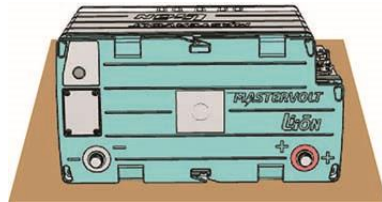

*Long side position*

- Keep at least 1cm [3/8"] between two Li-Ion batteries for air flow.
- The MLI Ultra must be secured. The following drawings are examples of mounting options:



With included mounting straps (stationary applications only)



Hold-downs on long side (group 49)

11 mm  
0.4 inch



With a frame or tray

## Materials needed

- Battery charger
- Use a T-fuse or an MRBF fuse and a fuse holder. Interrupting Rating (also known as DC breaking capacity or Ampere Interrupt Capacity): 15kA.  
This manual assumes that an MRBF fuse is used.
- DC wiring

	MLI Ultra 12/1250	MLI Ultra 24/1250
Recommended fuse	200 A	100 A
Recommended wire size	70 mm <sup>2</sup> [AWG 2/0]	35 mm <sup>2</sup> [AWG 2]



### WARNING!

The wire and fuse sizes stated in this manual are only guidelines. Cross section depends on the maximum system current.

Always comply with all local rules and regulations.

## Installation procedure for a single unit



### WARNING!

In installations with a negative earth: Connect the negative cable last of all to prevent short circuiting.



### WARNING!

Never mount a stud fuse directly to the battery terminal without a fuse holder! If there is not enough space, use a separate bus bar to mount the fuse on.

Step 1. Switch off all loads and chargers.

Step 2. Insert the handle into the recesses on the top of the battery.

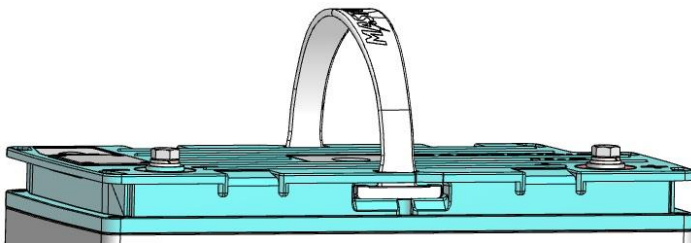

Step 3. Out of the box, the battery is on (switch is closed). Press the Battery switch-button to switch-off (*safety disconnect*). LED C will blink for 1 minute to indicate that the battery is off (switch is open).

Step 4. Secure the battery in place.

Step 5. Mount an MRBF fuse holder directly on the battery's POSITIVE terminal, add the fuse and the POSITIVE cable. Tighten the bolt. Never mount a stud fuse directly on the battery terminal. Always use the isolated fuse holder! Otherwise the fuse will not work! See the following figure.

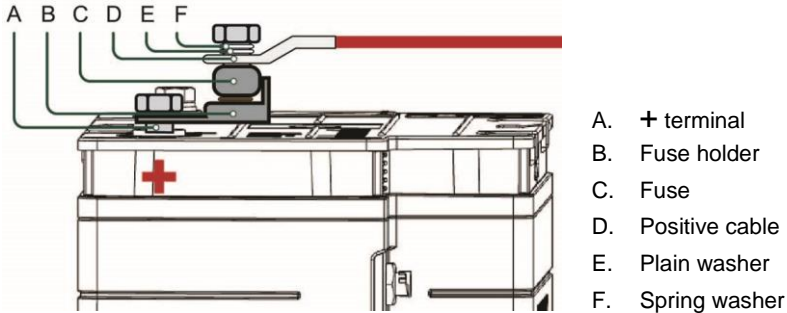

Figure 4: mounting a stud fuse

Connect the negative cable to the – terminal.

Recommended torques: 14.7 – 19.6 Nm / 130 – 170 InLbs.

Step 6. Option: connect the 6-pin auxiliary connector cable. See page 14 for details.



Step 7. Option: connect communication cables.



- MasterBus: connect two MasterBus cables (or one cable and one Terminator). See Figure 5 on page 13.

- CZone: connect the drop cable. On the battery side, plug the connectors into either of the communication ports. See Figure 6 on page 13.



Step 8. Press the Battery switch-button for 5 seconds to switch the battery on. LED C will be solid on for 1 minute to indicate that the switch is closed.

Step 9. Switch on some loads and verify that they are working. Switch off the load, switch on the charger and verify (charger status) that the battery is being charged.

To change the default settings according to your needs, either use the DIP switches or a configuration tool. For optimal use, it is strongly recommended to configure a *Stop charge* event. See page 21 for more information.

### Adding the MLI Ultra to a MasterBus network

MasterBus is a CAN based, fully decentralized data network for communication between Mastervolt devices. MasterBus is used as power management system for all connected equipment, such as the inverter, battery charger, generator and many more. Every device that is compatible with MasterBus is equipped with two data ports. The devices are simply daisy chained together, forming a local data network

1. Disconnect a MasterBus cable or Terminator from the closest MasterBus device and connect it to the MLI Ultra.
2. Connect the new MasterBus cable to the other MasterBus device and then connect to the MLI Ultra.

3. Ensure that the network is properly terminated.

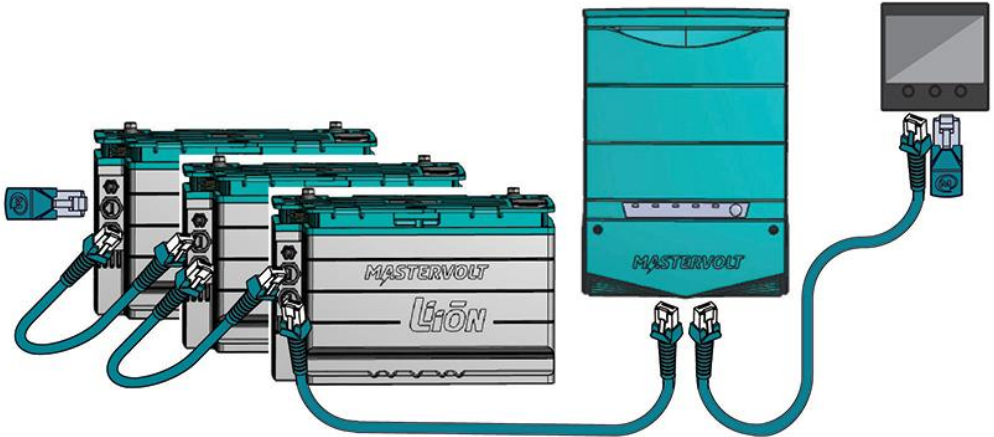

Figure 5: MasterBus cables

### Adding the MLI Ultra to a CZone network

The CZone network is an NMEA 2000-compliant CAN-based system. In a CZone network, the MLI Ultra can be monitored from a remote panel like the Touch 5. The settings can only be adjusted with the CZone Configuration Tool.

Additional required materials per MLI Ultra:

1. Disconnect the backbone at the closest backbone connection and add in a tee connector (not included).
2. Reconnect the backbone connection(s) with the new tee connector in place. Ensure that the network is properly terminated.
3. Connect the RJ45 CZone/MB drop cable to the black coupler on the tee and then connect to the MLI Ultra. On the battery side, plug the connectors into either of the communication ports. LED B will blink to confirm CZone network identification.

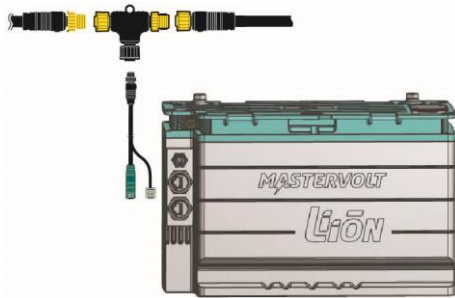

Figure 6: CZone drop cable

**Auxiliary connector**

FUNCTION	WIRE COLOR	PIN
Analog SoC output <i>Max rating: 1mA</i>	Green (0 – 10Vdc) Black (GND)	6 3
Aux. relay <i>Max rating: 30VDC/1A</i>	Yellow White	4 5
Not used	Red Blue	1 2

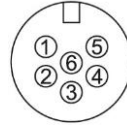

Figure 7: connector on the MLI Ultra

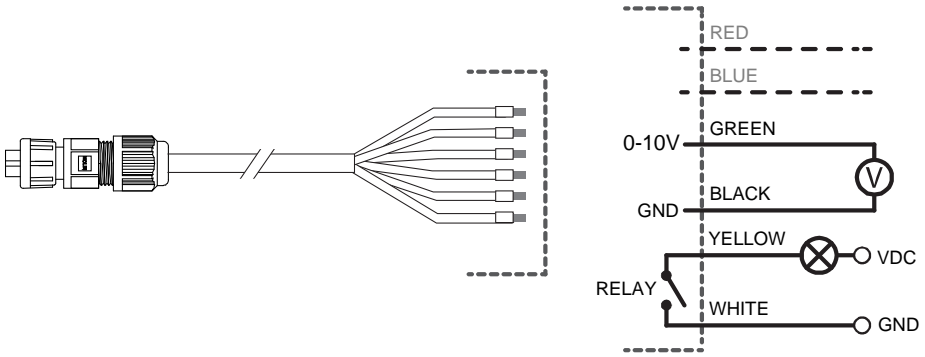

Figure 8: six wire ferruled auxiliary cable

• **State of Charge (SoC) indication**

Wire pair 3&6 can be used to monitor the SoC on external equipment, where 10V = 100% and 0V = 0%. To enable this, select the "SOC 0-10V" option in the Configuration tab, see page 17.

• **Auxiliary relay (dry contact)**

Wire pair 4&5 can be used to control an external device like a switch, relay or lamp. This is done in combination with a MasterBus event command or CZone circuit.

## 5. CONFIGURATION

Out of the box, the MLI Ultra is suitable for use in a MasterBus network or as a stand-alone battery. For CZone and for advanced features, the settings must be adjusted. Most settings can be done through DIP switches. Advanced or network settings are done from a Windows laptop or notebook with either the free MasterAdjust or the CZone configuration tool. MasterAdjust software can be downloaded at [www.mastervolt.com](http://www.mastervolt.com). The CZone Configuration Tool software is available to technical CZone customers from the CZone Portal.

### DIP switch settings

By default, all DIP switches are OFF.

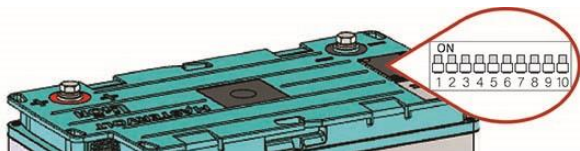

Figure 9: DIP switches

### MasterBus DIP switch settings

1. Set DIP switches 1 and 2 ON.
2. Set DIP switches 3 to 8 to fit your needs. DIP switches 9 and 10 are not used in MasterBus.

	DIP switch	3	4	5	6	7	8
Event-based 'stop charge' can be setup per charger:		0					
Automatic 'stop charge' for ALL Mastervolt chargers: (see also section "Stop Charge event" on page 21)		1					
Cluster setting for multi-unit configuration							
Stand-alone:		0	0	0			
Replica unit:		0	0	1			
Primary 12V unit:		0	1	0			
Primary 24V unit:		0	1	1			
Primary 36V unit:		1	0	0			
Primary 48V unit:		1	0	1			
(see section "Configuration of a battery bank" on page 25)							
'Auto switch-on' enabled:							0
'Auto switch-on' disabled:							1
'Battery detect' disabled:							0
'Battery detect' enabled:							1

Battery detect: If the battery is switched-off, there will be no voltage at the poles and some chargers will not start charging. By enabling the Battery detect option, this is fixed. Note if a load is connected that this will slowly drain the battery (5-10mA).

### CZone DIP switch settings

1. Set DIP switch 1 to the OFF position.
2. Set DIP switch 2 to the OFF position.
3. Set DIP switches 3 to 10 to match the unique 'dipswitch' number, used in the CZone network.

## How to change the DIP switch settings

1. Remove the DIP switch cover by loosening the four screws.
2. Use a small screwdriver to carefully change the DIP switch position.
3. Replace the DIP switch cover and fasten with the screws. Make sure that the rubber band is placed correctly, to make it watertight.

## Configuration in a MasterBus network

A display like the SmartRemote or EasyView 5, can be used to monitor the MLI Ultra. Advanced configuration can be done in MasterAdjust, from a Windows laptop or notebook connected to the MLI Ultra via a Mastervolt USB Interface. The following tables list the parameters as shown in MasterAdjust.

### Monitoring tab

Menu	Description
<b>Battery/Cluster</b>	
State of charge	Battery state of charge in %
Time remaining	Time of battery use left at the actual load in hh:mm:ss
Voltage	Battery voltage measured by the cell management system
Current	Current measured by the cell management system Positive value: charging, negative value: discharging
Temperature	Internal temperature of the battery in °C
<b>Battery switch</b>	
Switch close	Button to close the battery switch.
Switch open	Button to open the battery switch.
Switch state	State of the battery switch: open / close / unknown
<b>Note:</b> you need to login as installer to see all following parameters.	
<b>Installer</b>	
Battery safety	Indication of the occurrence of a Battery Safety event
Stop charge	Indication of the occurrence of a Stop charge event
MB power state	Indication whether MasterBus powering is on or off
Heater	This checkbox is marked when the heater is on
Aux. relay close	Closure of relay wire pair 4&5 of the auxiliary cable
Aux. relay open	Opening of relay wire pair 4&5 of the auxiliary cable.
<b>Voltage</b>	
Cell 1 ... 8	Voltage of the individual cells
<b>Balancer</b>	
Balancer 1...8	Indication of balancing of the individual cells
<b>Temperature</b>	
Temperature	Temperature of cells 1, 2-3, 4-5, 6-7, 8



**Alarms tab**

Menu	Description
<b>Generic</b>	
Battery safety	Indication of the occurrence of a Battery Safety event
Overcurrent	Battery current too high
Short circuit	Indication of a short circuit in the MLI Ultra
Capacity low	This alarm is raised when the State of charge (SoC) drops below a preset value (10% by default)
Cap. Very low	Indicates that the State of charge drops below a preset value (0% by default)
<b>Note:</b> you need to login as installer to see all following parameters:	
BMS failure	BMS error
Bat. switch err.	Battery switch error
Recovery failed	This checkbox is marked when the battery recovery has failed
Recovery active	This checkbox is marked when the battery is recovering

**History tab**

Menu	Description
Cycle count	The number of cycles so far
Last time 100%	Date of the last time that the MLI Ultra was fully charged
Max. Ah used	The maximum used capacity that the MLI Ultra saw
Lowest voltage	The lowest battery voltage that the MLI Ultra saw
Highest voltage	The highest battery voltage that the MLI Ultra saw

**Configuration tab**

Menu	Description	Default	Adjustable range
Name	Name of this device. This name will be recognized by all devices connected to the MasterBus network	MLI[serial number]	0-12 chars
Language	Menu language of this device	English	English, Dutch
Serial number	Serial number of the MLI Ultra		(read only)
DIP switches	Status of the DIP switches	0	(read only)
CZone	This checkbox is marked when the MLI Ultra is setup to work in a CZone network		(read only)
MB power	Off: MasterBus powering disabled. Automatic: MasterBus power will be switched off when the main current is in between 1.0A and -1.0A for more than 24 hours and the battery voltage has dropped below the float voltage. Always on: the MLI Ultra will power the MasterBus network. Note that this will slowly drain the battery. <b>Note:</b> MasterBus powering is only available if DIP switch 2 is ON.	Off	Off / Automatic / Always on

Menu	Description	Default	Adjustable range
Auto switch on	Select this option for automatic control of the battery switch.	On	On/off
Auto heater	Select this option for automatic control of the heater.	On	On/off
<b>Processor</b>			
Version	Firmware main version		(read only)
Revision	Product version		(read only)
Bootloader ver.	Bootloader version		(read only)
<b>Note:</b> you need to login as installer to see all following parameters.			
<b>Cluster</b>	See also section "Configuration of a battery bank" on page 25		
Nr. in series	The number of batteries in series	1	1-10
Nr. in parallel	The number of batteries in parallel	1	1-24
Confirm topology	Button to confirm the number of batteries in series and/or parallel		
<b>Event levels</b>			
Capacity low	Level below which the <i>Capacity low</i> event can be triggered	10%	0-100
Cap. very low	Level below which the <i>Cap. very low</i> event can be triggered	0%	0-100%
Battery full	Level above which the <i>Battery full</i> event can be triggered	100	0-100%
High temperature	Internal temperature of the MLI Ultra serves as an event source	45°C	30-60°C
Low temperature	Internal temperature of the MLI Ultra serves as an event source	5°C	30-60°C
Voltage low	Level below which the <i>Voltage low</i> event can be triggered	12.5V 25.0V	12.25-12.75V 24.5-25.5V
Volt. low delay	Delay time to trigger the <i>Voltage low</i> event after the level was reached	10s	1-120s
Last time 100%	Last time fully charged serves as an event source. To get accurate SoC readings, regularly charge the battery to 100%.	31 days	7-60 days

**Installer**

DOD	To optimize the battery cycle life, the Depth of Discharge (DOD) is set to 80%.	80%	20-100%
-----	---	-----	---------

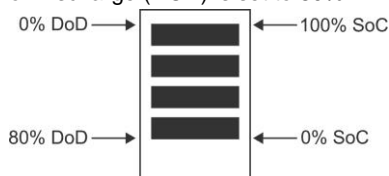
**CAUTION!**

Changing the DoD to 100% will decrease the cycle life.

Menu	Description	Default	Adjustable range
SOC 0-10V out	Select this option if the auxiliary connector is used to display the State of Charge.		
Test batt safety	Button to test if the battery switches-off when the 'battery safety'-conditions are met.		
Test stop charge	Button to test if the chargers stop charging when the 'stop charge'-conditions are met.		
Factory settings	Button to reset the MLI Ultra to its default settings		

### Events tab

With MasterBus a device can be programmed to initiate an action at another connected device that supports MasterBus. This is very helpful in automation of your system and is done by means of *event-based commands*.

In the Events tab you can program the MLI Ultra to act as an event source. Events which occur during the operation of the MLI Ultra will then trigger actions from other devices.

Field	Description	Value
Event x source	Select an event that triggers an action, for example Relay open.	See <i>Event source</i> list
Event x target	Select the device that should act, for example the charger.	Selectable targets are device dependent
Event x command	Select the parameter that must be changed on the target device, for example No connection.	See command list of the selected device

Event x data

Data translates the input into an output.

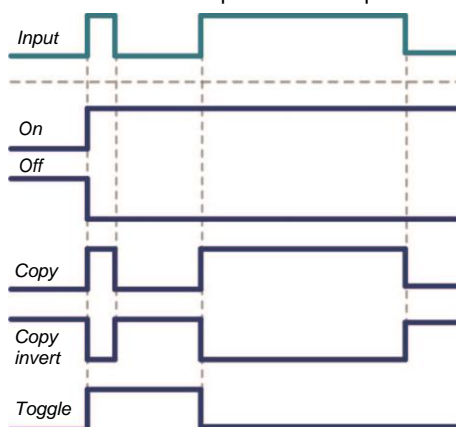
Off, On, Copy,  
Copy Invert,  
Toggle

- On: status changes to On at first input signal.
- Off: status changes to Off at first input signal.
- Copy: status follows input signal.
- Copy invert: status follows opposite of input.
- Toggle: status changes at 1<sup>st</sup> signal and back at the 2<sup>nd</sup>.

## Events sources

Event source	Condition	Comments
Disabled	(no event programmed)	
Battery Safety	Battery Safety event occurred and the safety relay is triggered to disconnect the battery from loads and charger.	See page 33 for what to do if the battery was switched-off.
Stop charge	Battery voltage > 14.5V/29V (12V/24V battery), or voltage or temperature of one of the individual cells is too high.	Strongly recommended event!
Charging	Battery charging current > 1A	Indicates that the battery is being charged
Capacity low	State of Charge < <i>Capacity low</i>	See <i>Configuration tab - Event levels</i> for adjustment of the threshold level
Capacity very low	State of Charge < <i>Capacity very low</i>	See <i>Configuration tab - Event levels</i> for adjustment of the threshold level See the related step of the installation procedure.
Battery full	State of Charge > <i>Battery full</i> .	See <i>Configuration tab - Event levels</i> for adjustment of the threshold level
Battery > 20%	State of Charge > 19.5 %	
Battery > 40%	State of Charge > 39.5 %	
Battery > 60%	State of Charge > 59.5 %	Can be used to control the LEDs on a MasterBus display for example

Event source	Condition	Comments
Battery > 80%	State of Charge > 79.5 %	
Battery 100%	State of Charge > 99.5 %	
High temperature	Internal temperature of the MLI Ultra is too high	See <i>Configuration tab - Event levels</i> for adjustment of the threshold level
Low temperature	Internal temperature of the MLI Ultra is too low	See <i>Configuration tab - Event levels</i> for adjustment of the threshold level
Voltage low	Battery or cell voltage is too low.	See <i>Configuration tab - Event levels</i> for adjustment of the threshold level
Last time 100%	Last time the MLI Ultra was fully charged	See <i>Configuration tab - Event levels</i> for adjustment of the threshold level
Switch open	<i>Switch open</i> event occurred	
Switch close	<i>Switch close</i> event occurred	
Over current	Battery over current event occurred	

### Event commands

When the MLI Ultra is configured as an *event target* by another device, this device can initiate an *event command* and an *event action* to be performed by the MLI Ultra.

Event command	Meaning
Switch close	The battery switch will be closed.
Switch open	The battery switch will be opened.
Aux. relay close	Closure of relay wire pair 4&5 of the auxiliary cable.
Aux. relay open	Opening of relay wire pair 4&5 of the auxiliary cable.
Heater on	Turn on the heater of the MLI Ultra (provided that the temperature of the MLI Ultra is below 0°C [32°F]).

### Stop Charge event

Before the battery reaches the limits of the operating specifications, the Stop Charge event is triggered. When configured, this event forces the Mastervolt charger to switch off and resume after 10 minutes. The settings depend on the used charger because different chargers have different state options. Check the manual of the used charger for how to switch the charging state.



#### WARNING!

If multiple charging devices are used to charge the battery (for instance both an AC powered charger and an alternator) then the Stop charge event must be configured for each charging device. In case of a battery bank, this must be done for each battery.

The Stop charge event can also be configured by setting DIP switch 3 ON. In this case, all connected Mastervolt chargers will stop charging when a 'Stop Charge'-condition is met. If a Mastervolt charger is added to the MasterBus network later in time, the Stop Charge event will automatically be configured for the new charger.

Examples of Stop charge events:

Event # source	Event # target	Event # command	Event # data
Stop charge	Alpha Pro III	Suspend charging	Copy
Stop charge	ChargeMaster	State	Copy invert
Stop charge	ChargeMaster Plus	Suspend charging	Copy
Stop charge	CombiMaster	Charger	Copy invert
Stop charge	Mac Plus	Standby	Copy
Stop charge	Mass charger	On/Standby	Copy invert
Stop charge	Mass Combi Pro/Ultra	Charger	Copy invert
Stop charge	SCM-60 MPPT	On/Off	Copy invert

### Configuration in a CZone network

Either do the configuration while connected to the network or use a prepared configuration file (.zcf). Ensure that a Dipswitch is assigned.



For detailed information on the configuration, please refer to the CZone® Configuration Tool Instruction manual, and section Configuration in a MasterBus network on page 16, which describes the parameters as shown in MasterAdjust.

**Precondition:** This section assumes that a CZone system is already configured and the CZone Configuration Tool is open.

1. In the CZone Configuration Tool, from the Modules tab, click the **Add** button.
2. Enter an understandable **Module Name**.
3. From the **Module Type** drop-down list, select **Battery (BAT)**.
4. Each device on a CZone network has a unique CZone address; the **Dipswitch**. This number must match the physical DIP switch settings. When connected to the system: either select one from the drop-down list or edit graphically.
5. From the **Battery Type** drop-down list, select the required model.
6. Option: click the **Advanced Settings** button to configure advanced options.
7. **NMEA2000 Instances** are used to differentiate between multiple monitoring sources.
8. To optimize the battery cycle life, the **Depth of Discharge Remaining (DoD)** is set to 80%.



#### CAUTION!

Changing the DoD to 100% will decrease the cycle life.

9. Tick **Show Battery Temperature** to enable temperature monitoring.
10. Click **OK** to return to the Module Modification window and then click the **Alarm/Switch Settings** button.
11. Set the required alarm levels and Alarm Severities.  
Battery level 1, 2 and 3 can be used for State of Charge switching.
12. Click **OK** to close the Battery Alarm/Switch Settings window.

13. Click **OK** to close the Module Modification window.

The following steps configure the safety behavior. For example, a *Stop Charge* switch that stops a generator and/or battery charger. Or a *Battery safety* switch that pauses the charging process of an alternator.

**Note:** This must be done for all MLI Ultra units and for all charging devices.

14. Click on the **Circuits** tab and **Add** a new circuit (bottom left).
15. Enter the **Circuit Name** (e.g. Stop Charge or Battery Safety) and click **OK**.
16. Click the **Add** button in the **Circuit Control** panel.
17. From the **Control Interface** drop-down list, select the required MLI Ultra unit.
18. From the **Control Input** drop-down list, select **Stop Charge**.
19. Click **OK**.

Return to step 16 until all MLI Ultra units have this switch configured.

20. Click the **Add** button in the **Circuit Loads** panel.
  21. From the **Load** drop-down list, select the required charger.
  22. Set the **State** to **Off**.
  23. Click the **Timer/Advanced Settings** button.
  24. 'Stop Charge' circuit switch only: from the **Control Type** drop-down list, select **Set Limit** and click **OK**.
  25. Click **OK** to close the Circuit Load Configuration window.
- Optionally, return to step 20 to do this for all chargers.
26. Return to step 14 to configure more circuits.
  27. Write the configuration to the network to use the new configuration.

## 6. BUILDING A BATTERY BANK

The MLI Ultra supports 12V, 24V, 36V and 48V systems.

### Requirements:

- Only create battery banks with batteries of the same type and capacity.
- The batteries have the same product code and software version. Do not mix with other models.
- Make sure that all batteries are fully charged before creating a battery bank to ensure balancing is optimized.
- Use properly sized fuses and wiring.
- Keep the cables between the batteries as short as possible.
- All battery-to-busbar cables should be of the same length.
- Install the batteries as close as possible to the charger.
- We recommend one charger for batteries that are connected in series.
- It is best practice to label the batteries (e.g. Primary, Replica1, Replica2).

### Series and parallel connections

**Note:** in the following drawing, the fuses are not depicted. Always use properly sized fuses in the positive cables of each battery.

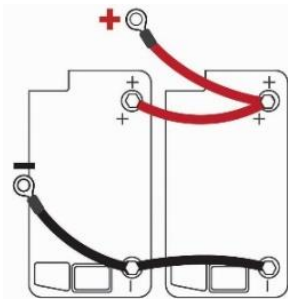

2 x 12V parallel = 12V / 200Ah  
2 x 24V parallel = 24V / 100Ah

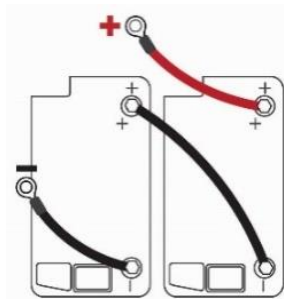

2 x 12V series = 24V / 100Ah  
2 x 24V series = 48V / 50Ah

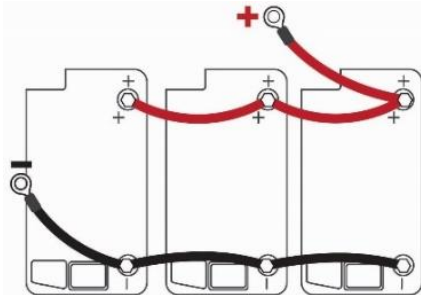

3 x 12V parallel = 12V / 300Ah  
3 x 24V parallel = 24V / 150Ah

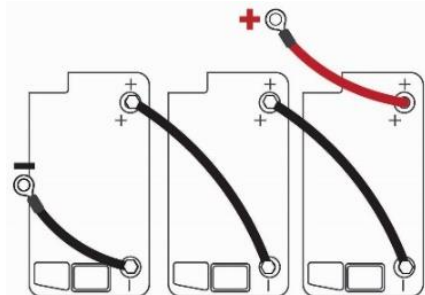

3 x 12V series = 36V / 100Ah



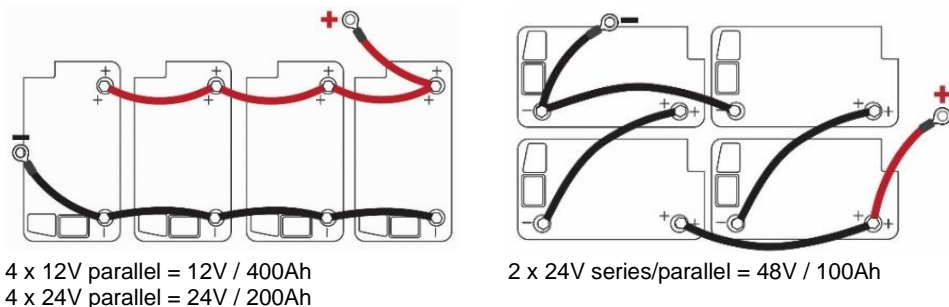

Figure 10: Simplified diagram for battery bank DC connections

### Configuration of a battery bank

Several batteries in series and/or parallel is called a cluster. A cluster can contain up to 24 devices in total (up to 48V). One MLI Ultra (it does not matter which one) is the Primary unit, the others are called replica units.

There are two ways to configure a cluster: using DIP switches or using a configuration tool. In a MasterBus network, a series OR a parallel connection can be configured with DIP switches. A combination of series and parallel connections must always be configured with a configuration tool, either MasterAdjust or the CZone Configuration Tool.

#### Battery bank configuration with DIP switches (MasterBus only)

All replica units must have DIP switches 4, 5 and 6 in this position: 001. Where 0 is OFF and 1 is ON. Their behavior is determined by the setting of the Primary unit. DIP switches cannot be used for series/parallel combinations. See section "How to change the DIP switch settings" on page 16 for how to access the DIP switches.

Model MLI 12/1250	DIP switch		
	4	5	6
Replica unit	0	0	1
Primary unit 12V system (all batteries in parallel)	0	1	0
Primary unit 24V system (2x batteries in series)	0	1	1
Primary unit 36V system (3x batteries in series)	1	0	0
Primary unit 48V system (4x batteries in series)	1	0	1

Model MLI 24/1250	DIP switch		
	4	5	6
Replica unit	0	0	1
Primary unit 24V system (all batteries in parallel)	0	1	1
Primary unit 48V system (2x batteries in series)	1	0	1

When all batteries are connected, the Primary unit will check the configuration.

If the cluster is incomplete or incorrect, LED B keeps blinking 3 times. Possible causes:

- Too many replica units
- Too many primary units
- Replica unit missing
- Primary unit missing
- Incorrect system voltage (e.g. 24V model set as 36V system)

**Examples:**

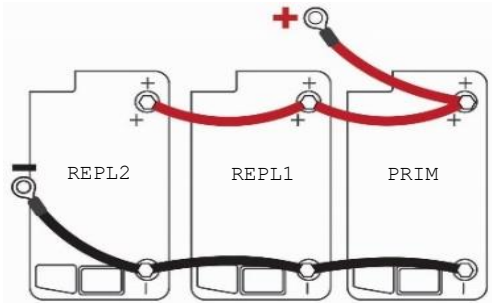

3 x 12V parallel (12V system)

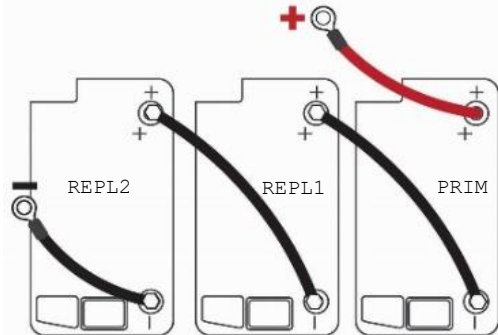
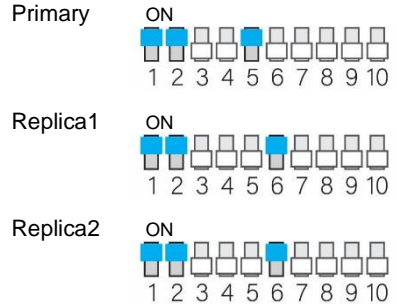

3 x 12V series (36V system)

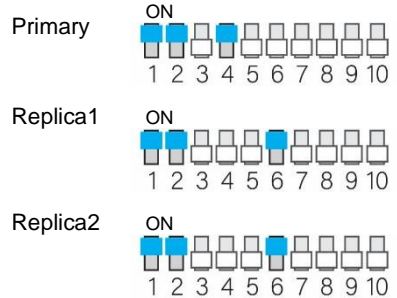

### Battery bank configuration with MasterAdjust

When all batteries are connected to MasterBus, open MasterAdjust. The MLI Ultra will be recognized by the MasterBus network automatically.

1. Right-click USB:MasterBus... and select **Login**.
2. Select **Installer** and enter the installer code.
3. Select the MLI Ultra that will act as Primary and go to the **Configuration** tab.
4. Enter the number of batteries in the **# series (S)** field.  
If there are no batteries in series, enter 1.
5. Enter the number of batteries in parallel in the **# parallel (P)** field.  
If there are no batteries in parallel, enter 1.
6. Click the **Confirm topology** button.

Notice the status of the cluster topology. It can be:

- Approved;
- Needs approval: the topology was not confirmed;
- Not activated: the topology still requires activation;
- Too many devices/Double device/Incomplete/Missing self: the proposed topology is not possible or other units need to be selected.

After confirmation, the cluster topology is defined and fields to select the other units will appear.

7. In the **S01** field, the Cluster **Primary battery** will be shown.
8. In the following fields, select the other replica batteries.
9. Click the **Activate** button.

Now, each battery will show its individual data in the monitoring tab while the Primary battery will show both the individual data and the data of the cluster.

Activation will fail if the battery is already in another cluster.

Cluster

Nr. in series  
2

Nr. in parallel  
2

Confirm topology

Cluster topology  
Needs approval

Confirm topology

Cluster status  
Missing self

Activate

To access the individual batteries, unfold the cluster (i.e. click the plus sign) in the left panel of MasterAdjust.

To identify the Primary battery, go to the configuration page of one of the batteries.

To remove a battery from a cluster, click the **Detach** button on the Configuration tab of the battery in question.

To breakdown a cluster, in the configuration of the Primary battery: set the cluster to 1 (series) by 1 (parallel) and click the **Confirm topology** button.

### Battery bank configuration with the CZone Configuration Tool

Preconditions: - a CZone system is already configured, including all batteries;  
- the CZone Configuration Tool opened the required configuration file.

1. In the CZone Configuration Tool, in the Modules tab, double-click the MLI Ultra that will act as Primary battery.
2. The Module Modifications window appears. Click the **Advanced Settings** button.
3. From the **Cluster Type** drop-down list, select **Cluster Primary**.
4. **Cluster DC Instance** is an NMEA2000 instance that is used to differentiate between multiple monitoring sources.
5. Enter a **Cluster Name**.
6. Click the **Configure Topology** button.  
The Configured Battery Cluster Topology window appears.
7. Enter the number of batteries in series (S). If there are no batteries in series, enter 1.
8. Enter the number of batteries in parallel (P). If there are no batteries in parallel, enter 1.
9. To activate voltage balancing of all cells in series, select ON from the Series Balancing drop-down list.
10. Click the **OK** button to return to the Advanced Settings window.
11. Click the **OK** button to return to the Module Modifications window and then click the **Alarm/Switch Settings** button.
12. The Battery Alarm/Switch Settings window appears. To copy these settings from the Primary battery to all secondary batteries, tick **Apply to cluster**.
13. Keep clicking **OK** until all dialog windows have disappeared.
14. Write the configuration to the network to use the new configuration.

To identify the Primary battery, go to the Meters tab. The battery with two DC instances is the Primary battery.

## 7. STORAGE AND CARE

If necessary, use a soft clean cloth to clean the MLI Ultra. Never use any liquids or acids.

The battery should be stored in a dry and well-ventilated environment. The rate of self-discharge is less than 3% per month. High or low ambient temperature affects the self-discharge rate of the batteries and natural aging.

If the battery will not be used for a period exceeding 3 months, we advise the following:

- If external AC power is available switch off all loads and switch on the charger. Apply a float voltage as specified in the following table.

Model	Float voltage setting
12V	13.5V
24V	27.0V

- If no external AC power is available:
  - Charge the battery to > 80% of its capacity before storage.
  - Long press the Battery switch-button to open the safety relay, see page 8.
  - Make sure MasterBus powering is not set to "Always on" (see Configuration tab in MasterAdjust).



### CAUTION!

In this setup the batteries can be kept at least 6 months without maintenance. However, it is highly recommended to charge the battery to over 80% of its capacity every 100 days.

## 8. TROUBLESHOOTING

To protect it from high/low temperature, high/low cell voltage, and over-current, the MLI Ultra 12/1250, 24/1250 automatically opens a built-in relay to disconnects it from the outside environment if thresholds are met. See chapter "SPECIFICATIONS" for the thresholds.

To close the safety relay, press the Battery switch-button.

Failure	Possible cause	What to do
No DC power available	A fuse has blown	Check all fuses and replace if necessary
	A cable or cable connection is defective	Check all cables and their connections. Replace if necessary.
	Crossing the threshold has triggered the safety relay.	Although the MLI Ultra is protected against too deep discharges, it will self-discharge during storage. If the MLI Ultra is deeply discharged, it will start the self-diagnosis to determine if it can or cannot be charged normally. If it cannot be charged normally and LED A is on, contact your Mastervolt dealer.
	Battery is switched-off (switch is open)	More than three auto switch-on attempts within 15 minutes will lead to a 15 minutes 'cool off' period. More than nine auto switch-on attempts within 60 minutes will stop the attempts. To re-enable auto switch-on, long press (for five seconds) the Battery switch-button.  If the battery was switched-off manually, long press (for five seconds) the Battery switch-button to switch-on again.
MasterBus display shows no MLI Ultra	The MasterView Easy has been configured to display selected devices only.	Check the option <i>All devices</i> or select the MLI Ultra to be displayed.
	Error in the wiring.	Check the MasterBus cables.
	No terminating device placed at the ends of the network.	MasterBus needs a terminating device on both ends of the network. Check if available.
	MasterBus network is configured as a ring network.	Ring networks are not allowed. Check the connections of the network.
	Battery is depleted.	Charge the battery.
Over-current alarm	Too heavy load on the battery.	Reduce load immediately.
LED A is red on	An unrecoverable error occurred.	Contact your Mastervolt dealer.
	One short blink, long pause: Low State of Charge	Charge the battery.

---

LED B is yellow blinking	Two short blinks, long pause: CZone identification in progress	No action required.
	Three short blinks, long pause: auto cluster configuration error	Check the DIP switch settings. See section "switches" on page 25.
	Four short blinks, long pause: auto recovery initiated	Wait for the auto recovery procedure to complete.
	Steady blinking: firmware update in progress	No action required.

---

## 9. SPECIFICATIONS

### Technical specifications

	MLI Ultra 12/1250	MLI Ultra 24/1250
<i>Part number</i>	66011250	66021250
<b>Electrical</b>		
Nominal capacity (Cn)	100 Ah	50 Ah
Nominal energy	1250 Wh	1250 Wh
Nominal voltage	12 V	24 V
Self-discharge	Less than 3% per month	
<b>Charging/discharging</b>		
Charge method	3-step+ (aka IUoUo)	
Bulk/absorption (max charge) voltage	14.25 V	28.5 V
Float voltage (end of charge)	13.5 V	27.0 V
Recommended charge current	50A (0.5C)	25A (0.5C)
Max continuous charge current	100A (1C)	50A (1C)
Max. continuous discharge current	200A (2C)**	100A (2C)
Max. discharge current (peak 10s)	500A (5C)	250A (5C)
Discharge cut-off voltage (> 0°C [32°F], <1C)	10V	20V
<b>Mechanical</b>		
BCI Group Size	Group 31 (footprint fits in group 49)	
Length (L)	330 mm [13"]	
Width (W)	173 mm [6.8"]	
Height (H)	210 mm [8.3"] excl. terminals and stud fuse, 228 mm [9"] incl. terminals	
Weight	15 kg [33 lbs.]	
Protection degree	IP65	
Chemistry	LiFePO4	
Case material	Plastic	
<b>Temperature</b>		
Operating temperature	-20 to 50°C [-4 to 122°F] *	
Nominal operating temp.	25°C / 77°F	
Storage temperature	-20 to 55°C [-13 to 131°F]	
Relative humidity	10 – 95% relative humidity, none condensing	



General	
Approvals	CE, E-mark, FCC, UN38.3 UL1642 (cellspack)
Cycle life	3000 cycles at 80% Depth of Discharge
Protection degree	IP65
Parallel configuration	Yes
Series configuration	Yes, up to 48V
Balancing mechanism	Passive
Integrated BMS	Yes
Integrated fuse	No
Integrated disconnect (safety) switch	Yes
MasterBus connectivity	Yes
Powering capabilities for MasterBus	Yes
CZone	Yes

\* Charging at temperatures below  $-5^{\circ}\text{C}$  /  $23^{\circ}\text{F}$  may result in battery not accepting charge current.  
Temperatures below  $5^{\circ}\text{C}$  /  $41^{\circ}\text{F}$  and above  $25^{\circ}\text{C}$  /  $77^{\circ}\text{F}$  may affect lifetime and cycle life.

\*\* Due to thermal protection, this high discharge current can be used for 3 minutes at or above an ambient temperature of  $25^{\circ}\text{C}$  [ $77^{\circ}\text{F}$ ].

### Battery switch – automatic behavior

CAUSE FOR AUTO SWITCH-OFF	CONDITIONS (for at least 30 seconds) FOR AUTO SWITCH-ON
<ul style="list-style-type: none"> <li>• Cell over-voltage</li> <li>• Cell under-voltage</li> <li>• Battery over-current</li> <li>• Cell over-temperature</li> </ul>	Cell voltages and temperatures are within safe operating range
<ul style="list-style-type: none"> <li>• Low SoC</li> </ul>	Charger is connected
<ul style="list-style-type: none"> <li>• Extreme over-temperature (<math>&gt; 85^{\circ}\text{C}</math> / <math>185^{\circ}\text{F}</math>)</li> <li>• BMS failure</li> </ul>	✘ Battery switched-off permanently

**Notes:**

- If DIP switch 6 is ON, then the auto switch-on feature is disabled.
- When the battery is switched-off manually, it also needs to be switched-on manually.

**Characteristics**

**Battery discharge characteristics and battery capacity at ambient temperature 25°C/77°F**

- 12/1250

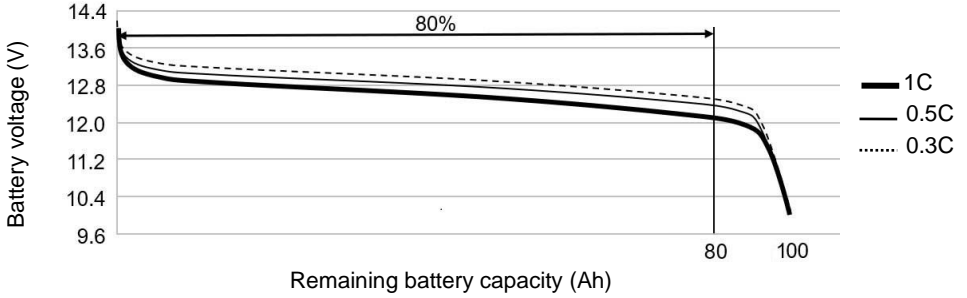

- 24/1250

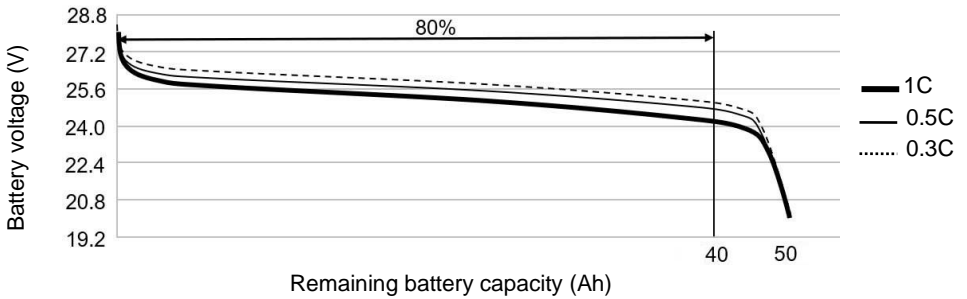

**Capacity retention over lifetime at ambient temperature 25°C/77°F**

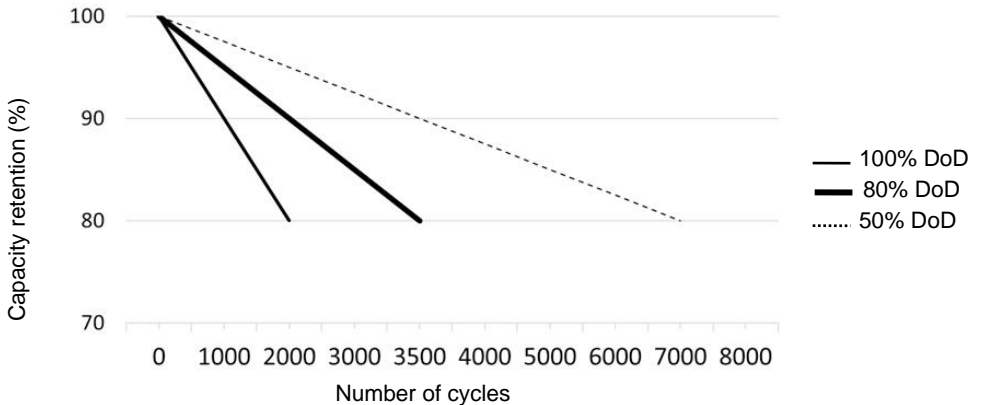

**Capacity retention at different cell temperatures**

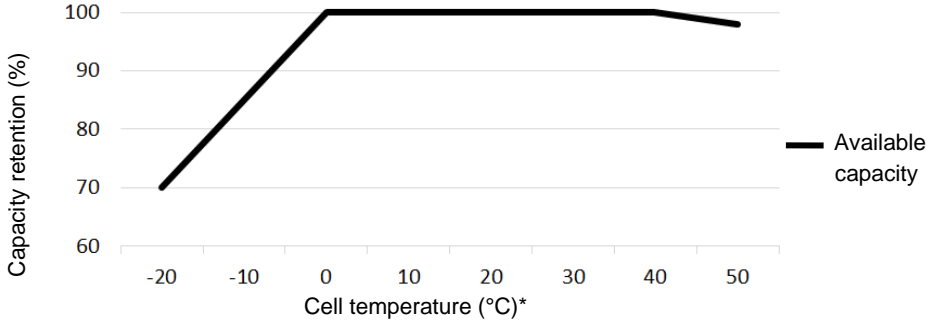

\* Cell temperatures are not necessarily equal to the ambient temperature of the battery!

**Cycle life retention at different ambient temperatures**

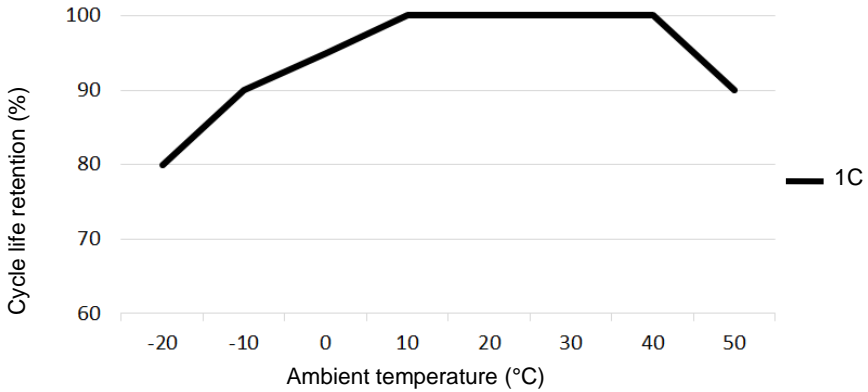

**Self-discharge in reflection to the storage temperature**

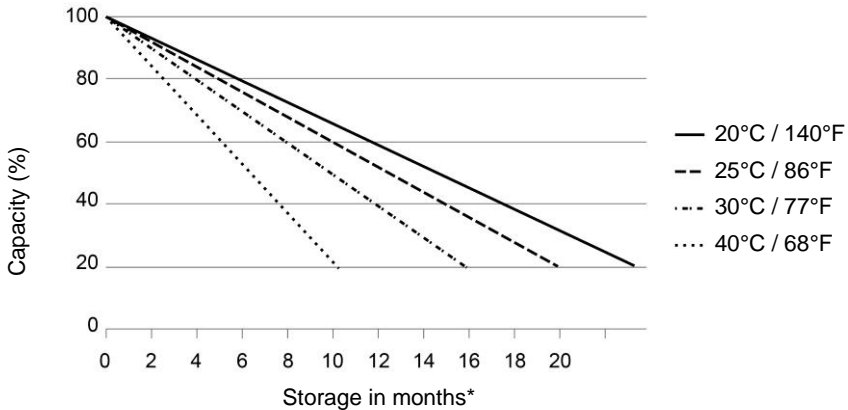

\* Provided that MasterBus powering is off and there is no communication to the BMS.



### **Europe, Middle East & Africa**

#### **Customer Service**

T: +31 (0) 20 34 22 100

E: [info.emea@OneASG.com](mailto:info.emea@OneASG.com)

#### **Technical Support**

T: +31 (0) 20 34 22 100

E: [ts.emea@OneASG.com](mailto:ts.emea@OneASG.com)

#### **Location & Shipping**

Advanced Systems Group EMEA

Snijdersbergweg 93

1105 AN Amsterdam

The Netherlands

### **Americas & Caribbean**

#### **Customer Service**

T: +1 800 307 6702, Option 1

E: [orderentry@OneASG.com](mailto:orderentry@OneASG.com)

#### **Technical Support**

T: +1 800 307 6702, Option 2

E: [tech.mastervolt@OneASG.com](mailto:tech.mastervolt@OneASG.com)

#### **Location & Shipping**

Advanced Systems Group US

N85 W12545 Westbrook Crossing

Menomonee Falls, WI 53051

United States

### **Asia Pacific**

#### **Customer Service**

T: +64 9 415 7261 Option 1

E: [sales.apac@OneASG.com](mailto:sales.apac@OneASG.com)

#### **Technical Support**

T: +64 9 415 7261 Option 3

E: [technical.apac@OneASG.com](mailto:technical.apac@OneASG.com)

#### **Location & Shipping**

Advanced Systems Group APAC

42 Apollo Drive

Rosedale, Auckland 0632

New Zealand