

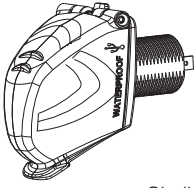

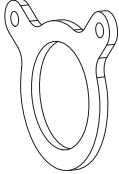
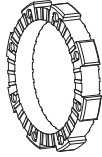

Parts List

 <p>Shell x1</p>	 <p>Gasket x1</p>	 <p>Lock Ring x1</p>	 <p>No. 4X16 Self tapping screw x2</p>
---	--	---	---

Tools Required

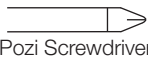
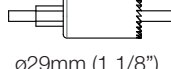
 <p>ø2.5mm (3/32") Drill Bit</p>	 <p>Pozi Screwdriver</p>
 <p>ø29mm (1 1/8") Hole Saw</p>	 <p>Silicone</p>

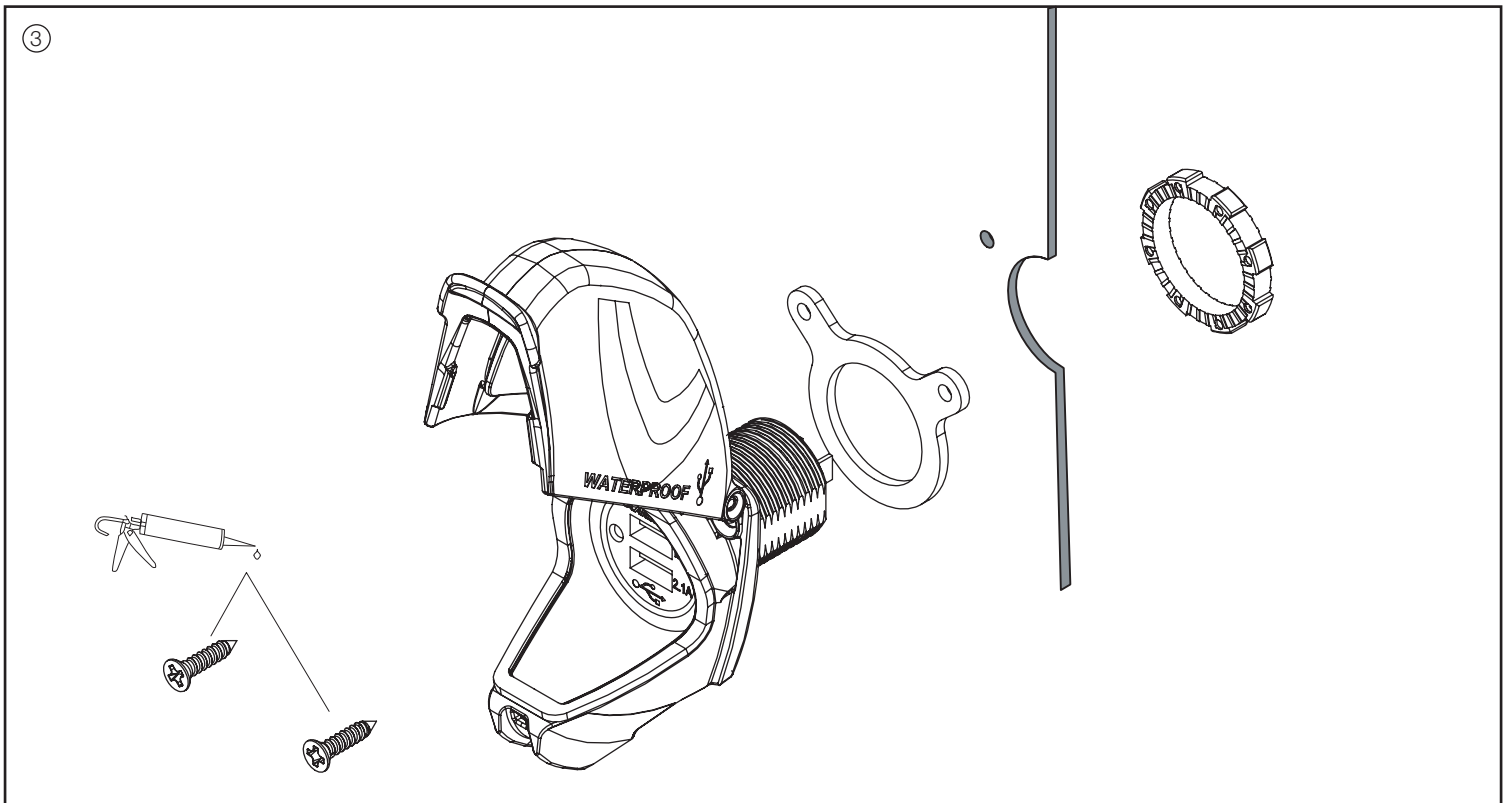
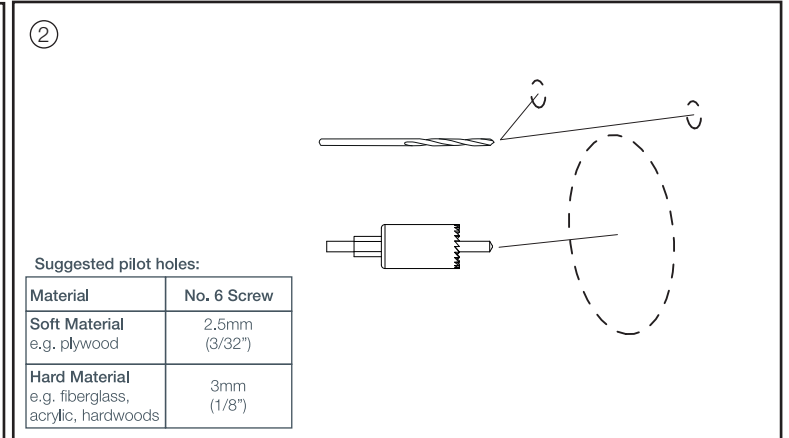
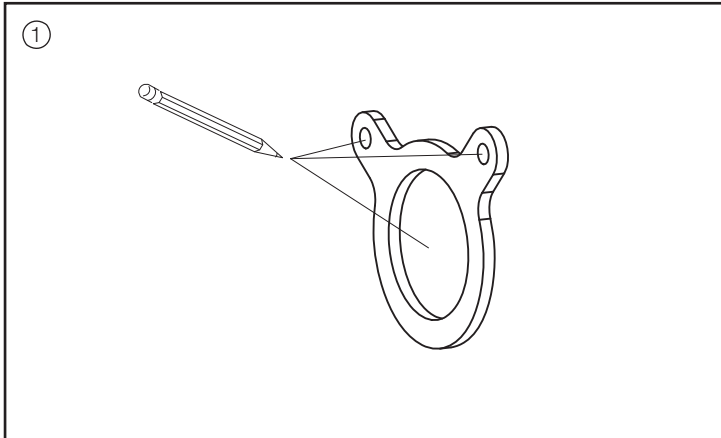

Share your installation with us.



UK & International
+44 (0)1392 531280
sales@scanstrut.com

For further installation
and warranty information
please visit:
www.scanstrut.com

USA
+1 860 308 1416
usasales@scanstrut.com