

## HOW TO ASSEMBLE A MASTERVISION PANEL

1. For best results, use Mastervision installation parts
2. Use connector bar 07-09-07810 and connector block 07-09-07820 to assemble the panel.
3. The mounting bolts used are M4x25
4. Secure the bolts with the supplied M4 nuts and O-rings.
5. To fasten the electrical panel in its frame or bulkhead use the stencil as supplied to cut the panelhole.
- 6.

Do not use connector blocks at the outside top or bottom edge. This is where the complete panel will be fastened to its frame or bulkhead.

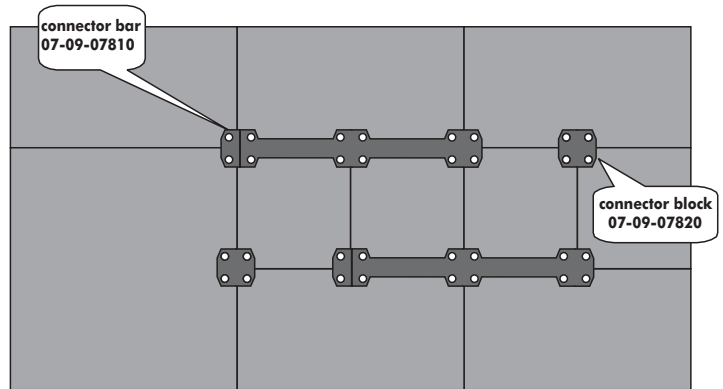

## HOW TO INSTALL THE BACKLIGHTING SYSTEM:

The Mastervision panels have a two-state backlight system for label illumination. The first state is a low intensity green light that illuminates the labels on the panel to enable label viewing in low light conditions, any time the circuit is switched ON or OFF. The second state is a higher intensity yellow DC LED (or orange neon lamp for AC) to indicate when a circuit is switched ON.

Power must be fed to all modules with backlight capability. This is achieved by linking all the modules together by their backlight connectors (see drawing). Verify the backlight AC or DC voltage on each module.

### Note:

The power supply voltages are equal on all backlight modules, indicator voltages are depending on the type of panel.

## 10/30V DC power supply for backlight

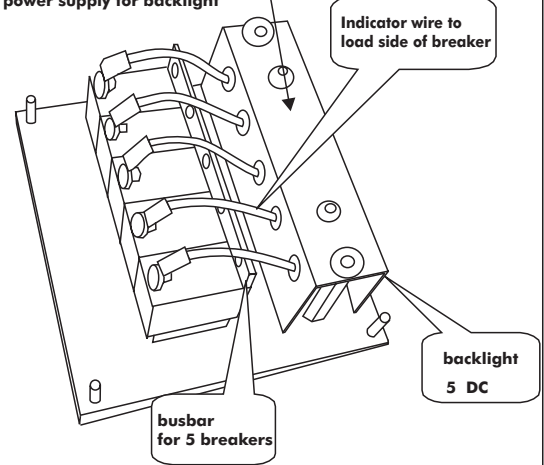

## HOW TO LABEL A BACKLIGHT

To place the labels on the backlight module remove the mounting bolts and turn the module around.

Place the label in the embossed square on the lens. Make sure that the label is placed correctly and the indicator led is uncovered.

Replace the backlight module in the original position.

### Warning:

When the module is placed correctly the indicator led is 1mm away from the transparent front lens.

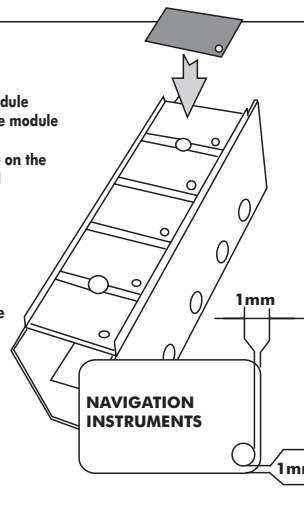

## DC MODULE

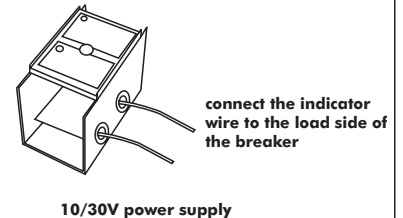

10/30V power supply

## AC MODULE

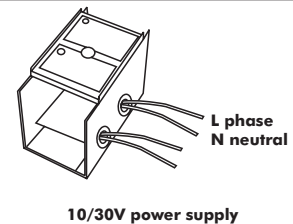

10/30V power supply

## CAUTION



1. Lethal voltages exist on your vessel. Make sure all shore power, onboard generating sources and batteries are disconnected before beginning installation of your electrical panel.
2. AC modules will have lethal voltages on the bus bars and terminals. Additional safety enclosures as the AC protection shield (part no. 07-09-04601-2-3) may be required in some installations.
3. Make sure all AC modules are bonded to the ship's AC ground bus. When grouping modules together to form your panel, a single ground may be used. Use an ohm meter to verify ground to all modules.

## GENERAL

1. Verify the modules you purchased are configured for the source voltage aboard your vessel / mobile. Refer to the backlight specification.
2. Installation of Mastervision panels should be completed by a person with a thorough knowledge of marine / mobile electrical systems.
3. Wiring to and from each module should conform to the local applicable standards and taking into consideration the safety guidelines and measures.

Mastervolt can accept no liability for damage due to the use of the panel or due to possible errors in the manual and the results thereof.

**INSTALLATION ACCESSORIES**

**BACKLIGHT MODULES**

- 07-09-04310 backlight module 5 labels 12/24V DC
- 07-09-04312 backlight module 2 labels 12/24V DC
- 07-09-04320 backlight module 5 labels 230V AC
- 07-09-04322 backlight module 2 labels 230V AC
- 07-09-04400 LED 12/24V 3mm flathead yellow (prewired) 10 each
- 07-09-04402 LED 12/24V 3mm flathead green (prewired) 10 each
- 07-09-04404 LED 12/24V 3mm flathead red (prewired) 10 each
- 07-09-04406 LED 12/24V 3mm flathead (4 x yellow/ 4 x green/ 2 x red)
- 07-09-04500 neon lamp 230V 6mm orange (prewired) 10 each

**CIRCUIT BREAKERS CARLINGSWITCH**

- 07-09-050xx circuit breaker type rocker AD 1 pole max 50A red
- 07-09-051xx circuit breaker type rocker AD 2 pole max 50A red
- 07-09-05091 circuit breaker type rocker AD 1 pole max 50A red with fingerguard
- 07-09-05093 circuit breaker type rocker AD 1 pole max 50A red push to reset
- 07-09-052xx circuit breaker type rocker CD 1 pole max 100A red
- 07-09-053xx circuit breaker type rocker CD 2 pole max 100A red
- 07-09-05301 circuit breaker type rocker CD 1 pole max 190A red (B-3-BS)
- 07-09-052xx circuit breaker type rocker MD 1 pole max 25A red

- 07-09-05600 panel hole plug A series rocker
- 07-09-05610 panel hole plug M series rocker

xx = breaker current value

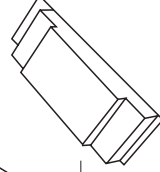
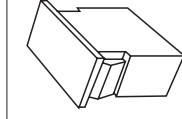
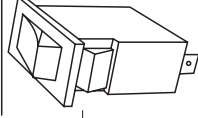
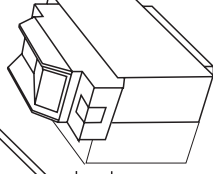
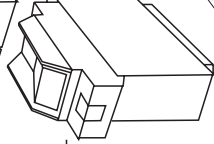
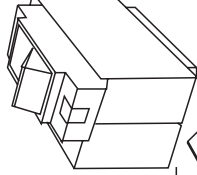
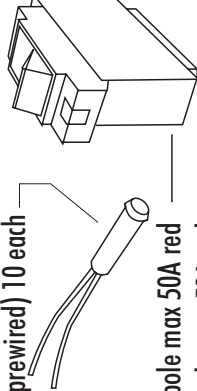
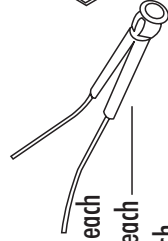
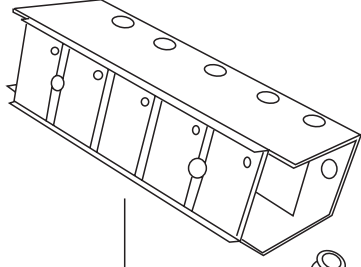

**PANEL SWITCHES**

- 07-09-07610 rockerswitch on-off 8A black
- 07-09-07620 rockerswitch on-off-on 8A black

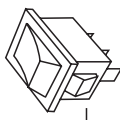

**INSTALLATION COMPONENTS**

- 07-09-07810 connector bar 145x20mm to connect 3 panels
- 07-09-07820 connector block 25x20mm to connect 2 panels
- 07-09-07840 bus bar to connect 2 breakers
- 07-09-07830 bus bar to connect 5 breakers

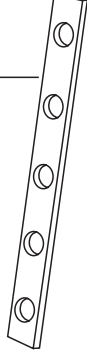
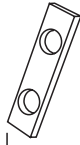

- 07-09-05700 terminal screws - hex. 10/32 - for breakers AD series (10 each)
- 07-09-05710 terminal screws - hex. 8/32 - for breakers MD series (10 each)

**LABELSHEETS**

- 07-09-07910 labelsheet 1 with 143 labels english
- 07-09-07920 labelsheet 2 with 143 labels dutch
- 07-09-07930 labelsheet 3 with 143 labels french
- 07-09-07940 labelsheet 4 with 143 labels german

main breaker	mass charger
outlets AC 220 V	panel lights

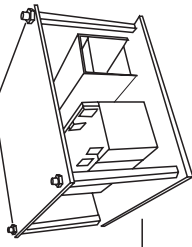

**AC PROTECTION SETS**

- 07-09-04601 AC protectionshield for panel 1
- 07-09-04602 AC protectionshield for panel 2
- 07-09-04603 AC protectionshield for panel 3

