

Generator Weights and Dimensions

	Without Sound Shield		With Sound Shield
	HX/KC*	RAD*	HX/KC*
Weight, kg (lb.)			
Wet	1127 (2485)	1159 (2555)	1250 (2755)
Dry	1091 (2405)	1123 (2475)	1213 (2675)
Length, mm (in.)	1657 (65.24)	1992 (78.43)	1754 (69.06)
Width, mm (in.)	753 (29.65)	890 (35.05)	831 (32.72)
Height, mm (in.)	999 (39.33)	1477 (58.15)	1032 (40.62)

* HX/KC = Heat Exchanger/Keel Cooled Model, RAD = Radiator Model
Above dimension excludes exhaust outlet. Refer to appropriate ADV for detailed dimensions.

Marine Generator Set

Generator Features

- Engine is Environmental Protection Agency (EPA) Tier III compliant (60 Hz model only)
- The unique Fast-Response® X excitation system delivers excellent voltage response and short-circuit capability using a rare-earth permanent magnet-excited alternator
- The brushless, rotating-field alternator has broadrange reconnectability
- Remote control connector
- Class H insulation
- Reconnectable voltage
- One- or three-phase reconnectable alternator
- Voltage regulation of ±0.5%
- Frequency regulation of 0.5%
- Heat exchanger cooled configuration includes a wet exhaust bend
- Keel cooled configuration includes a dry exhaust bend

Optional Agency Type Approvals

- Det Norske Veritas- Germanischer Lloyd (DNV- GL)
 - China Classification Society (CCS)
 - Lloyd's Register
 - Bureau Veritas (BV)
 - American Bureau of Shipping (ABS)
- Agency requirements:
- Extra senders, exhaust blankets, and double wall fuel lines with leak alarm
 - 3 separate Type Approval documents for engine, alternator, and Decision-Maker® 3500 controller



Generator Ratings (Prime)

Model	Heat Exchanger/Keel Cooled Models				Radiator Models		
	Generator (Alternator)	Voltage	Hz	Ph	Amps	Rated kW/kVA	Amps
80EOZDJ (4R9X)	120/208	60	3	278	80.0/100.0	278	80.0/100.0
	120/240	60	3	241	80.0/100.0	241	80.0/100.0
	127/220	60	3	262	80.0/100.0	262	80.0/100.0
	139/240	60	3	241	80.0/100.0	241	80.0/100.0
	277/480	60	3	120	80.0/100.0	120	80.0/100.0
70EFOZDJ (4R9X)	110/190	50	3	266	70.0/88.0	266	70.0/88.0
	110/220	50	3	230	70.0/88.0	230	70.0/88.0
	120/208	50	3	243	70.0/88.0	243	70.0/88.0
	220/380	50	3	133	70.0/88.0	133	70.0/88.0
	230/400	50	3	126	70.0/88.0	126	70.0/88.0
	240/416	50	3	121	70.0/88.0	121	70.0/88.0

RATINGS: Ratings per ISO 3046, ISO 8528-1, and Kohler ISO rating guideline 2.14. Obtain technical information bulletin (TIB-101) on ratings guidelines for complete ratings definitions. Availability is subject to change without notice. Kohler Co. reserves the right to change the design or specifications without notice and without any obligation or liability whatsoever. Contact your local Kohler generator set distributor for availability.
10% overload capacity one hour in twelve hours.

Application Data

Engine

Engine Specifications	60 Hz	50 Hz
Type	Inline, 4-cycle	
Number of cylinders	4	
Firing order	1-3-4-2	
Aspiration	Turbocharged and aftercooled	
Displacement, L (cu. in.)	4.48 (273)	
Bore and stroke, mm (in.)	107 x 127 (4.21 x 5.00)	
Compression ratio	16.7:1	
Combustion system	Direct injection	
Rated rpm	1800	1500
Maximum power at rated rpm, HP	148	120
Cylinder block material	Cast iron	
Cylinder head material	Cast iron	
Piston rings	2 compression/1 oil	
Crankshaft material	Forged steel	
Connecting rod material	Forged steel	
Governor type	Electronic isochronous	

Engine Electrical

Engine Electrical System	60 Hz	50 Hz
Battery, voltage	12- or 24-volt spec isolated ground, standard	
Battery, charging (12 volt)	75 amp	
Battery, charging (24 volt)	50 amp	
Battery, recommendation (min., 12 volt)	925 CCA	
Starter motor	Gear-reduction type	

Cooling

Cooling System	60 Hz	50 Hz
Capacity, L (U.S. qt.) (approx.), HX/KC* RAD*	17 (18) 34 (36)	
Cooling type, HX* RAD*	Heat exchanger Radiator	
Seawater pump type, HX/KC*	John Deere gear driven	
Seawater pump suction lift, maximum, m (ft.), HX/KC*	3.0 (10.0)	
Heat rejected to jacket water at rated kW, kW (Btu/min.)	123 (7001)	103 (5863)
Engine water pump flow, Lpm (gpm)	155 (40.9)	136 (36)
Seawater pump flow, Lpm (gpm), HX/KC*	189 (50)	155 (41)

Fuel

Fuel System	60 Hz	50 Hz
Fuel recommendation	Diesel fuel specified to EN 590 or ASTM D975	
Fuel shutoff solenoid	Electric	
Fuel injection system	High Pressure Common Rail (HPCR)	
Fuel pump priming	Self priming	
Maximum recommended fuel lift, m (ft.)	2.4 (7.9)	

* **HX** = Heat Exchanger, **KC** = Keel Cooled, **RAD** = Radiator Model

Lubrication

Lubricating System	60 Hz	50 Hz
Oil pan capacity with filter, L (U.S. qt.)	18 (19)	
Type	Pressure	

Operation Requirements

Air Requirements	60 Hz	50 Hz
Engine combustion air requirements, m ³ /min. (cfm)	8.5 (301)	5.9 (209)
Max. air intake restriction, kPa (in. H ₂ O)	6.25 (25)	6.25 (25)
Cooling air required for generator set at 50°C (122°F) ambient, m ³ /min. (cfm)		
HX/KC*	24.35 (860)	21.10 (745)
RAD*	218.0 (7700)	181.9 (6425)
Exhaust flow, m ³ /min. (cfm)	19.4 (685)	14.7 (519)
Exhaust temp., °C (°F)	434 (813)	488 (910)
Max. allowed exhaust backpressure, kPa (in. H ₂ O)	7.5 (30)	7.5 (30)

Fuel Consumption	60 Hz	50 Hz
Diesel, Lph (gph) at % load		
100%	24.22 (6.40)	21.65 (5.72)
75%	18.88 (4.99)	16.58 (4.38)
50%	13.55 (3.58)	11.54 (3.05)
25%	8.21 (2.17)	6.51 (1.72)

Engine Features

- One-side serviceability of fuel system, lubrication system, and air cleaner
- Low oil pressure cutout
- High water temperature cutout
- Loss of coolant cutout
- Overcrank cutout
- Belt guard
- Optional digital gauge
- Disposable oil filter
- Extended oil drain
- PTO options: 12- or 24-volt electric clutch

Controller Features

- A graphical display and pushbutton/rotary selector dial provide easy, local data access.
- Measurements are selectable in metric or English units.
- The controller supports Modbus® protocol with serial bus (RS-485) or Ethernet networks.
- Scrolling display shows critical data at a glance.
- Graphical display of power metering (kW, kVA, V, I, PF, and VAR).
- Integrated hybrid voltage regulator.
- Built-in alternator thermal overload protection.

Modbus® is a registered trademark of Schneider Electric.

Decision-Maker® 3500 Paralleling Controller



Provides advanced control, system monitoring, and system diagnostics for optimum performance and compatibility. The Decision-Maker® 3500 controller uses a patented hybrid voltage regulator and unique software logic to manage alternator thermal overload protection features normally requiring additional hardware. Additional features include:

- **AC Output Voltage Regulator Adjustment.** The voltage adjustment provides a maximum adjustment of $\pm 10\%$ of the system voltage.
- **Alarm Silence.** The controller can be set up to silence the alarm horn only when in the AUTO mode for NFPA-110 application or Always for user convenience.
- **Alternator Protection.** The controller provides generator set overload and short circuit protection matched to each alternator for the particular voltage/phase configuration.
- **Automatic Restart.** The controller automatic restart feature initiates the start routine and re crank after a failed start attempt.
- **Cyclic Cranking.** The controller has programmable cyclic cranking.
- **ECM Diagnostics.** The controller displays engine ECM fault code descriptions to help in engine troubleshooting.
- **Engine Start Aid.** The configurable starting aid feature provides customized control for an optional engine starting aid.
- **Event Logging.** The controller keeps a record (up to 1000 entries) for warning and shutdown faults. This fault information becomes a stored record of system events and can be reset.
- **Historical Data Logging.** Total number of successful starts of the generator is recorded and displayed.
- **Integrated Hybrid Voltage Regulator.** The voltage regulator provides $\pm 0.5\%$ no-load to full-load RMS voltage regulation with three-phase sensing.
- **Lamp Test.** Press the alarm silence/lamp test button to verify functionality of the indicator lights.
- **LCD Display.** Adjustable contrast for improving visibility.
- **Measurement Units.** The controller provides selection of English or metric displays.
- **Power Metering.** Controller graphical display provides voltage, current, power factor, kW, kVA, and kVAR.
- **Programming Access (USB).** Provides software upgrades and diagnostics with PC software tools.
- **Remote Reset.** The remote reset function supports acknowledging and resetting faults and allows restarting of the generator set without going to the master control switch off/reset position.
- **Run Time Hourmeter.** The generator set run time is displayed.
- **Time Delay Engine Cooldown (TDEC).** The TDEC provides a time delay before the generator set shuts down.
- **Time Delay Engine Start (TDES).** The TDES provides a time delay before the generator set starts.
- **Voltage Selection Menu.** This menu provides the capability to switch the generator output voltage. NOTE: Generator set output leads may require reconnection.
- **Paralleling Functions:**
 - Bus sensing
 - First on logic
 - Synchronizing
 - Communication based isochronous load sharing
 - Droop load sharing
 - External controlled load sharing via analog bias signals

Alternator Specifications

Alternator Specifications

Specifications	Alternator
Manufacturer	Kohler
Type	4-pole, rotating-field
Exciter type	Brushless, rare-earth permanent-magnet
Number of leads	12, reconnectable
Voltage regulator	Solid state, volts/Hz
Insulation: NEMA MG1	
Material	Class H
Temperature rise	115°C
Bearing: number, type	1, sealed
Coupling	Flexible disc
Amortisseur windings	Full
Voltage regulation, no load to full load	$\pm 0.5\%$
One-step load acceptance per NFPA 110	100% of rating
Peak motor starting kVA:	(35% dip for voltages below)
480 V, 400 V	4R9X (12 lead)
	385 (60 Hz), 296 (50 Hz)

Alternator Features

- NEMA MG1, IEEE, and ANSI standards compliance for temperature rise and motor starting.
- Capable of sustained line-to-neutral short circuit current of up to 300% of the rated current for up to 2 seconds. Capable of sustained short circuit current of up to 300% of the rated current for up to 10 seconds for 3 phase connections. (IEC 60092-301 short-circuit performance.)
- Sustained short-circuit current enabling downstream circuit breakers to trip without collapsing the alternator field.
- Self-ventilated and drip-proof construction.
- Vacuum-impregnated windings with epoxy varnish for dependability and long life.
- Superior voltage waveform from a two-thirds pitch stator and skewed rotor.

Optional Accessories

- Modular sound shield manufactured with 5052-H32 aluminum in powder-coated Matterhorn white
- Circuit breakers
- Remote digital display
- Remote monitoring, start/stop panel with wiring harness for connection to the generator controller
- Duplex fuel filter
- Siphon break
- Remote connection/extension harness
- Oil level indicator (high/low)
- Low coolant level indicator
- Electric front clutch power takeoff (PTO)
12- or 24- volt

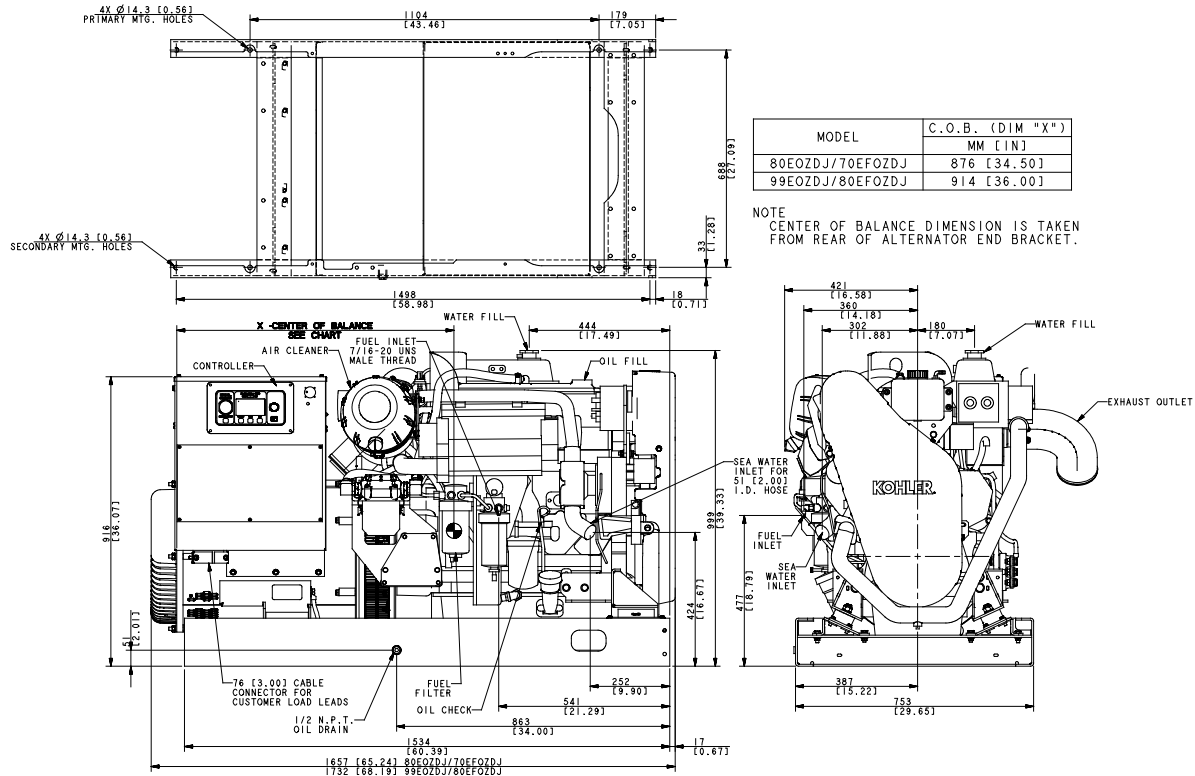

ADV-8506-C

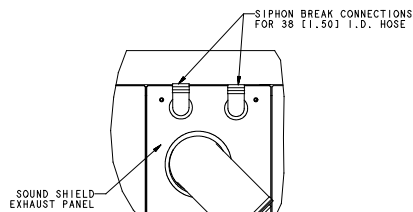

OPTIONAL SIPHON BREAK KIT SCALE 0.250

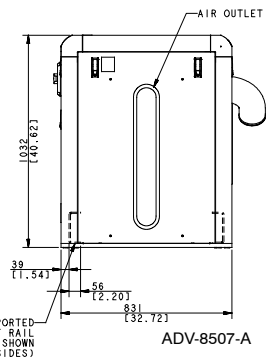
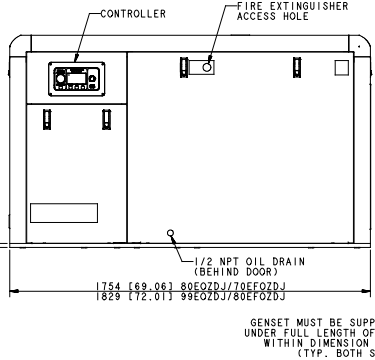
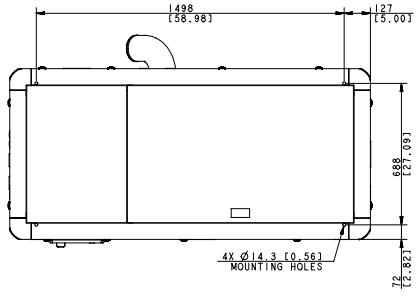
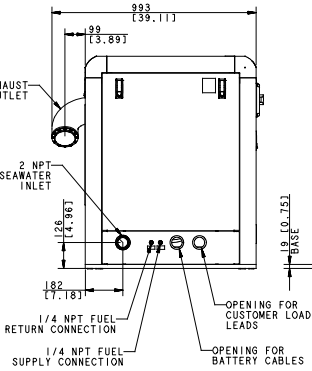
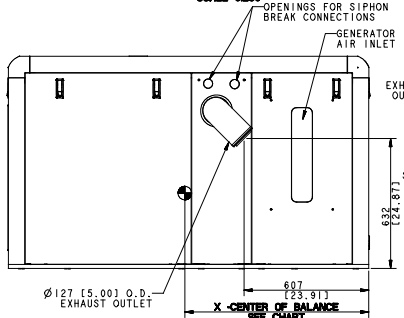

ADV-8507-A

DISTRIBUTED BY:

NOTE: Dimensions are shown in mm [in.].
 NOTE: This drawing is provided for reference only and is not intended for installation planning. Contact your local distributor for more detailed information.