



AUTOMATIC BILGE PUMP

Features

- Patented X-Air™ anti-airlock impellor
- Mechanical Float with microswitch
- Non Return Valve recommended for any installation

Certifications, Standards and Listings:

The Sahara Mk2 pumps meet or exceed the following U.S. and international standards

- Bilge pumps standards
 - ABYC H-22
 - ISO 8849
 - ISO 15083
- Ignition Protection Standards
 - ISO 8846 Marine
 - ABYC C-1500
 - U.S. Coast Guard Rule, 33CFR-183.410
- Marine Electrical Wiring Standards
 - ABYC E-11
 - ISO 10133
 - U.S. Coast Guard Rule, 33CFR-183.425
- Approvals: NMMA “As approved Listing”; CE; RCM; UKCA



Part No.	NMMA	CE	RCM	UKCA
5505 Series	TBC	✓	✓	✓
5507 Series	TBC	✓	✓	✓
5508 Series	TBC	✓	✓	✓
5511 Series	TBC	✓	✓	✓

Model No.	Rated Voltage (D.C.)	Fuse Size *	Hose Size (Internal Diameter)	NRV Included?	Wire Length	Bulk Packaging	Retail Packaging
S500	12-volt	2 Amp	¾" (19mm) and 1" (25mm)	Y	29 ½" (750mm)	5505-1	5505-7
			¾" (19mm) barb outlet	N		5505-2	n/a
S800	12-volt	5 Amp	¾" (19mm) and 1" (25mm)	Y		5508-1	5508-7
			¾" (19mm) barb outlet	N		5508-2	n/a
S800	24-volt	3 Amp	¾" (19mm) and 1" (25mm)	Y		5509-1	5509-7
			¾" (19mm) barb outlet	N		5509-2	n/a
S1200	12-volt	6 Amp	1" (25mm) and 1-1/8" (28mm)	Y		5512-1	5512-7
			1-1/8" (28mm) barb outlet	N		5512-2	n/a
S1200	24-volt	3 Amp	1" (25mm) and 1-1/8" (28mm)	Y		5513-1	5513-7
			1-1/8" (28mm) barb outlet	N		5513-2	n/a

Materials ABS – pump body and float, PBT (GF) Impeller, SS316 – Motor Shaft, nitrile seals.

Activation Depth	1-3/4" (50mm)
Deactivation Depth	¾" (19mm)
Minimum water level capability using override wire	500 – 12mm (½") 800/1200 – 6mm (¼")
IP Rating	IP68



* - recommend using automotive blade type fuses

AUTOMATIC BILGE PUMP

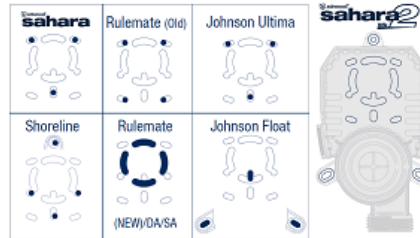
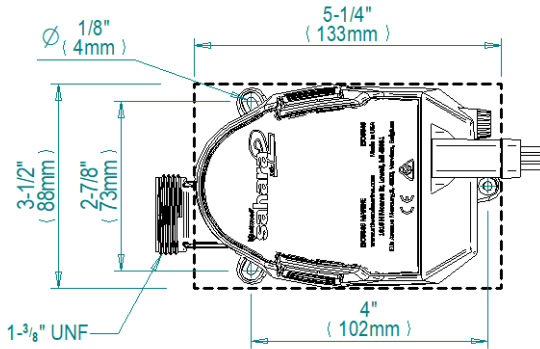

Sahara M k2 M mounting options

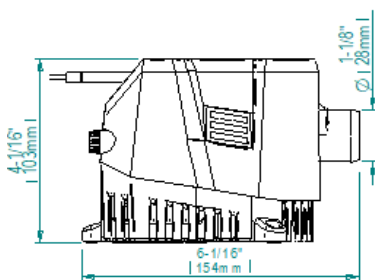

Sahara M k2 1200 Barb

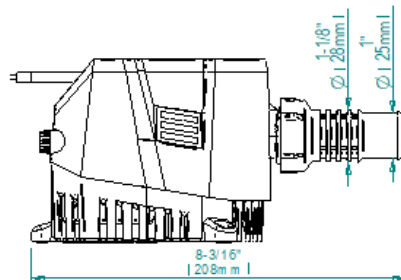

Sahara M k2 1200 with Straight

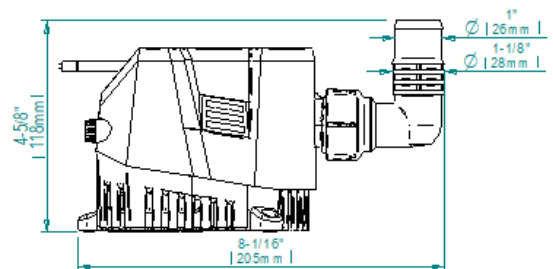

Sahara M k2 1200 with elbow

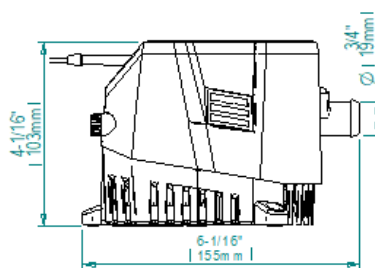

Sahara M k2 500/800 Barb

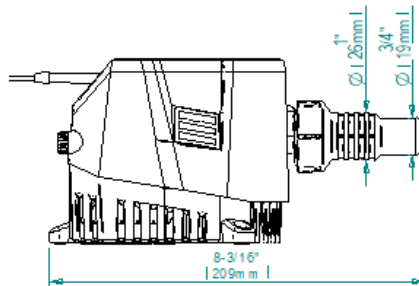

Sahara M k2 500/800 with Straight

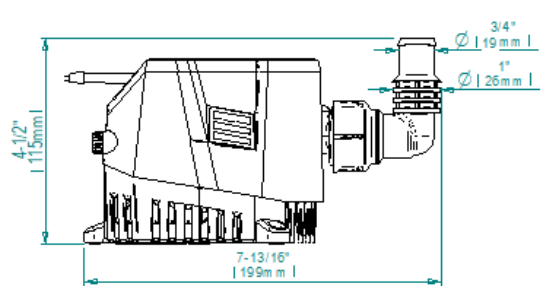

Sahara M k2 500/800 with elbow

