



Translation of the original operating instructions

Travel - Travel XP



Table of contents

1 Introduction	6
1.1 General information about the manual	6
1.2 Version and validity	6
1.3 Digital operating manual	6
2 Explanation of symbols	7
2.1 Layout of warning notices	8
2.2 About this operating manual	9
3 Safety	10
3.1 Intended use	10
3.2 Foreseeable misuse:	10
3.3 Safety features	11
3.3.1 Motor safety features	11
3.3.2 Battery safety features	11
3.4 General	12
4 Product description	14
4.1 Serial number and type plate	14
4.1.1 Type plate	14
4.1.2 Motor identification	14
4.1.3 Battery identification	14
4.1.4 Propeller identification	15
4.2 Controls and components	16
4.2.1 Travel	16
4.2.2 Travel remote	17
4.2.3 Display and buttons	18
4.3 Scope of supply	18
4.3.1 Motor	18
4.3.2 Battery	20
4.4 Equipment registration	20
5 Technical information	21
5.1 Selection of the correct shaft length	21
5.2 Technical characteristics	21
5.2.1 Transom bracket	21
5.2.2 Travel	22
5.2.3 Travel Remote	23
5.2.4 Battery	23
5.3 Operating conditions	24
5.3.1 Operating conditions for operation	24
5.3.2 Operating conditions for charging	24
5.3.3 Operating conditions for storage	24

5.4 Technical data	24
5.4.1 Data and dimensions	24
5.4.2 Protection class according to DIN EN 60529	25
5.5 Information about conformity	26
5.5.1 Declaration of Conformity	26
5.6 Patents	26
6 Installation and fitting on the boat	27
6.1 Fitting the propeller	27
6.2 Fitting the fin	28
6.3 Fitting the motor to the boat	29
6.3.1 Requirements for fitting to boat	29
6.3.2 Fitting the motor	29
6.4 Installing Remote Adapter Kit	30
6.4.1 Installing the frame plate	30
6.4.2 Attaching the data cable	31
6.4.3 Fitting the cover	31
6.4.4 Installing the steering tube	31
6.5 Fitting the steering plate	32
6.6 Connecting the remote steering	33
6.7 Fitting the accelerator	34
6.7.1 Fitting the accelerator to the boat	34
6.7.2 Lay accelerator data cable and connect to motor	34
6.8 Fitting long tiller arm	35
6.8.1 Remove/install tiller handle	35
6.8.2 Calibrating the tiller	37
7 Operation	38
7.1 Software update	38
7.2 Operation in emergency situations	38
7.3 Transom bracket	39
7.3.1 Steering lock	39
7.3.2 Motor tilt device	40
7.3.3 Shallow water positions	40
7.3.4 Tips for trimming the motor	41
7.3.5 Trimming the motor	42
7.3.6 Steering brake	43
7.4 Tiller	43
7.4.1 Tiller lock and resistance	43
7.5 On-board computer	44
7.5.1 Operation and membrane keyboard	44
7.5.2 Main screens	44

7.5.3	Brightness	45
7.5.4	Messages	46
7.5.5	Bluetooth and Bluetooth password	46
7.5.6	Settings	47
7.6	Battery and charger	48
7.6.1	Charging the battery	48
7.6.2	Battery status LED	49
7.6.3	Inserting the battery into the motor and removing it	50
7.7	Before setting off	51
7.8	On return	52
7.9	Driving	53
8	Storage and transport	54
8.1	Towing the boat with the motor fitted	54
8.2	Transport and shipping	54
8.3	Storage of the battery	54
9	Care, maintenance and repair	56
9.1	Maintenance and service intervals	56
9.2	Care	56
9.2.1	Cleaning	56
9.2.2	Corrosion protection	57
9.3	Maintenance and repair	57
9.3.1	Anodes	58
9.3.2	Replacing the propeller shaft anode	59
9.3.3	Replacing the transom bracket anode	59
9.3.4	Replacing the transom bracket ring anode	60
9.3.5	Propeller	60
9.3.6	Removing the propeller	60
9.3.7	Fitting the propeller	60
9.3.8	Replacing the fin	61
9.3.9	Lubricating the remote steering	62
9.3.10	Lubricating the hybrid plug	62
9.3.11	Plug connectors	62
10	Errors and troubleshooting	63
10.1	Error notifications and messages	63
10.2	Faults and errors	64
11	Accessories and replacement parts	65
12	Copyright	66
13	General guarantee conditions	67
14	Disposal and the environment	68

Foreword

Dear valued customer,

Thank you for choosing emission-free boating with Torqeedo. Your new electric propulsion system has been carefully designed, ethically manufactured and conscientiously tested with great care and attention to ensure that you are completely satisfied.

Please take some time to read this operating manual carefully so that you can use your system properly and enjoy it for a long time to come. If you have any questions or concerns, please contact us or your local service centre. You will find all the contact details online at [Torqeedo.com](https://www.torqeedo.com).

At Torqeedo, we create the pleasure of powerful movement on the water - with respect for our human and natural environment.

We are delighted that you are joining us on this mission and would like to welcome you on board.

Your Torqeedo Team

EN

1 Introduction

1.1 General information about the manual



Follow these instructions for proper and safe use. Keep for future reference

1.2 Version and validity

This operating manual is valid for the following Torqeedo motors:

Motor type	Steering	Shaft length	Item number
Travel S	Tiller	(S) 62.5cm	1160-00
Travel L	Tiller	(L) 75.0cm	1161-00
Travel XP S	Tiller	(S) 62.5cm	1162-00
Travel XP L	Tiller	(L) 75.0cm	1163-00
Travel XP S R	Remote	(S) 62.5cm	1164-00
Travel XP L R	Remote	(L) 75.0cm	1165-00

Battery type	Capacity	Compatible with	Item number
Travel battery	See type plate	Travel / Travel XP	1166-00
Travel XP battery	See type plate	Travel / Travel XP	1167-00

1.3 Digital operating manual



You can also download the current version of the operating manual as a PDF from our homepage. www.torqeedo.com

Make the most of our range of purely digital operating manuals! They include a lot of additional information about your product. You can access them via the app or on our homepage or you can scan the code.

2 Explanation of symbols

The following symbols, warnings and mandatory signs can be found in this manual and on your product.

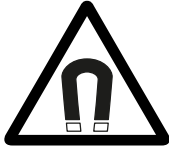

Magnetic field



Attention: fire hazard



Read the instructions carefully



Do not tread on or place under load



Attention: hot surface



Attention: electric shock



Attention: Danger from rotating parts



Do not dispose in household waste



Recyclable



Caution: risk of crushing



Attention magnetic field, data carriers can be deleted



People with pacemakers or other medical implants must keep a distance of at least 50 cm from the system

2.1 Layout of warning notices

Warning notices are presented in this manual in a standard format and with standard symbols. Observe the instructions. The hazard classes defined below are used in accordance with the probability of occurrence and the severity of the consequence.

Warnings:



DANGER

Immediate hazard with high risk. Death or serious bodily injury may result if the risk is not avoided.



WARNING

Possible hazard with moderate risk. Death or serious bodily injury may result if the risk is not avoided.



CAUTION

Hazard with low risk. Minor or moderate bodily injury may result if the risk is not avoided.

Warnings:

DANGER! Observe instructions! Immediate hazard with high risk. Death or serious bodily injury may result if the risk is not avoided.

WARNING! Observe instructions! Possible hazard with moderate risk. Death or serious bodily injury may result if the risk is not avoided.

CAUTION! Observe instructions! Hazard with low risk. Minor or moderate bodily injury may result if the risk is not avoided.

Notes:

NOTICE! Instructions, which must be observed to avoid material damage.

Tips:

TIP! User tips and other useful information.

2.2 About this operating manual

Handling instructions

Handling instructions to be completed are presented as a list. The order of the steps must be followed.

Example:

- a) Step
- b) Step

Results

Results of a handling instruction are presented as follows:

Example:

- a) Step
 - ⇒ Interim result
 - ⇒ Result

Enumerations

Enumerations that have no compulsory order are shown as a list of bullet points.

Example:

- Item 1
- Item 2

3 Safety

3.1 Intended use

Intended use:

The Travel and Travel XP motors, in conjunction with the battery types offered, are suitable for inflatable boats, dinghies and daysailers. The motors are designed for operation in sea water and fresh water, as well as in bodies of water without chemicals. They are fitted to an attachment point (transom) on a boat which is designed for the output of the motor used.

Intended use also includes:

- Fitting the system to the attachment points provided at the stern of the boat and compliance with the prescribed torques.
- Operating the system on bodies of water with sufficient depth.
- Observing all the instructions in this manual.
- Complying with the maintenance and service intervals.
- Using only original replacement parts and original accessories.

3.2 Foreseeable misuse:

Foreseeable misuse:

Any use other than or exceeding the use specified under "Intended use" is considered unintended use. The operator bears sole responsibility for damage resulting from unintended use, and the manufacturer accepts no liability whatsoever.

Among other things, the following is considered unintended use:

- Underwater deployment of the system.
- Operation in waters to which chemicals are added.
- Use of the system outside of marine craft.
- Use of the system at attachment points in the boat other than those at the stern.
- Modifications to the product that are not described in this manual.
- Operation of the propeller outside water.

3.3 Safety features

3.3.1 Motor safety features

Safety features	Function
Emergency stop magnetic chip	Causes the motor to shut off immediately. The propeller comes to a standstill, the system remains switched on.
Electronic protection against uncontrolled start-up	Prevents uncontrolled start-up of the system after switching on. To drive, the accelerator lever/tiller must first be moved to the neutral position and the emergency stop magnetic chip must be put in place.
Tiller / accelerator	Ensures that the system can only be started in neutral to prevent uncontrolled start-up of the system:
Overheating protection by means of the battery management system (BMS)	Automatically reduces the power of the electronics or the motor to prevent overheating.
Overcurrent protection by means of the battery management system (BMS)	Automatically reduces the power if excess current is detected in the electronics or the motor.
Motor protection	Protects the motor from thermal and mechanical damage if the propeller is blocked, e.g. by ground contact or lines caught up in it.
Broken cable protection	Immediate shut-off of the motor in the event of damage or short-circuit of a connection cable.

3.3.2 Battery safety features

Safety features	Function
Fuse	A fuse in the battery prevents overcurrent and/or short-circuit in the event of a defect.
Overheating protection by means of the battery management system (BMS)	Automatically reduces the power of the electronics or battery to prevent overheating.
Overcurrent protection by means of the battery management system (BMS)	Automatically reduces the power if excess current is detected in the battery.
Broken cable protection	Immediate shut-off of the motor in the event of damage or short-circuit of a connection cable.
Battery management system (BMS)	The BMS monitors all parameters during operation, charging and storage and switches off the components affected if necessary.

3.4 General

- Be sure to read and observe the safety and warning instructions in this manual!
- Read the manual carefully before putting the system into operation.
- Observe local laws and regulations and obtain any certificates of competence required.

Failure to observe these instructions may result in personal injury or material damage. Torqeedo cannot accept any liability for damage caused by actions that contradict responsible use or these instructions.

Basics

Local safety and accident prevention regulations must also be observed when operating the system.

The system has been designed and manufactured with the utmost care and attention in terms of convenience, user-friendliness and safety, and thoroughly tested before delivery.

Nevertheless, if the system is not used as intended, danger to life and limb of the user or third parties and extensive material damage may occur.

Before use

The system may only be operated by persons with the appropriate qualifications and who demonstrate the required physical and mental aptitude. Observe the applicable national regulations.

Instruction in the operation and safety regulations of the system is provided by the boat builder or by the dealer or seller.

As the boat's operator, you are responsible for the safety of the persons on board and for all marine craft and persons in your vicinity. Be sure to observe the basic rules of boating conduct and read this manual thoroughly.

Particular caution is required when people are in the water. Stop the motor and do not use it if there are people close by in the water.

Observe the boat manufacturer's instructions in relation to the permissible motorisation of your boat. Do not exceed the specified load and power limits.

Check the condition and all functions of the system (including the emergency stop) at low power before every journey.

Familiarise yourself with all the controls of the system. Above all, you must be able to stop the system quickly when necessary.

General safety information

- Observe the safety regulations.
- Depending on the size of the boat, always have the necessary safety equipment ready (anchor, paddle, means of communication, auxiliary drive if necessary).
- Check the system for mechanical damage before starting out.
- Only operate a system that is in perfect working order.
- Familiarise yourself with the area you are traveling through before setting off, as the range shown on the onboard computer does not take account of wind, current or direction of travel.
- Allow a sufficient buffer for the required range.
- Find out about the area you intend to travel through before you set off and observe the forecast weather and sea conditions.
- Consider the effect of your boat on the range under the environmental conditions expected.
- Attach the emergency stop magnetic chip cord to the skipper's wrist or lifejacket.
- Keep away from the propeller.
- Watch out for people in the water.
- Switch off the Torqeedo system if people are in the immediate vicinity of the propeller.
- While driving, make sure that there is no danger of the propeller touching the ground.
- Do not touch any motor or battery components during or immediately after operation.

- Secure the boat to the landing stage or berth so that it cannot break free when you are not using the boat or if you are adjusting the settings on the menu.
- There must always be one person on the boat at the time of calibration.
- The emergency stop magnetic chip can erase magnetic data carriers.
- Keep the emergency stop magnetic chip away from magnetic data carriers.
- Only use original Torqeedo spare sets.
- Only use Torqeedo chargers.
- Always unroll cable drums completely.
- Only use charging cables that are undamaged and suitable for outdoor use.
- Do not carry out any independent repair work on the Torqeedo system.
- Always switch off the Torqeedo system via the on/off button during installation and disassembly work and disassemble the battery.
- Do not wear loose clothing or jewellery near the drive shaft or propeller. Tie up loose, long hair.
- Do not carry out any maintenance or cleaning work on the drive shaft or propeller while the Torqeedo system is switched on.
- Only operate the propeller under water.
- Battery terminals must be clean and corrosion-free.
- When working on the propeller, always switch off the system via the main battery switch and remove the emergency stop magnetic chip.
- Do not use the Torqeedo system if the battery, cables, housings or other components are damaged and inform Torqeedo Service.
- Switch off the Torqeedo system immediately at the main battery switch or remove the battery from the motor in case of overheating or smoke.
- Do not store any flammable objects near the Torqeedo system.
- Avoid strong mechanical forces on the batteries and cables of the Torqeedo system.
- Never touch frayed or severed cables or obviously defective components.
- If a defect is detected, switch off the Torqeedo system immediately at the main battery switch and do not touch any metal parts.

4 Product description

4.1 Serial number and type plate

4.1.1 Type plate

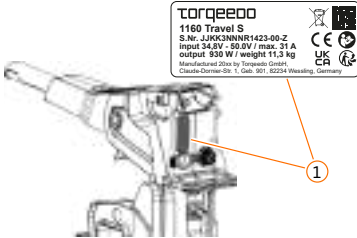

(1) Position of the type plate on the motor

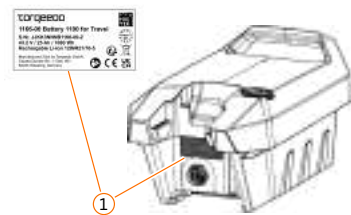

(1) Position of the type plate on the battery

4.1.2 Motor identification

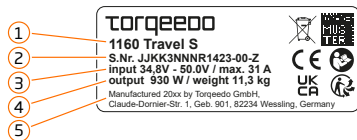

Motor type plate

1. Item number and motor type
2. Serial number
3. Nominal input voltage/max. input current
4. Nom. shaft output power/weight
5. Address

4.1.3 Battery identification



Battery type plate

1. Item number and battery type
2. Serial number
3. Nominal voltage / Capacity in Ah / Capacity in Wh / Cell type
4. Address
5. Time for inspection or disposal of the battery.

4.1.4 Propeller identification

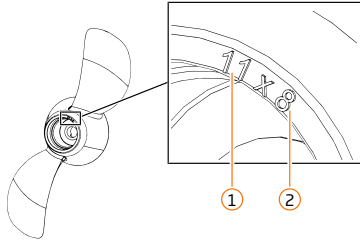

1. Diameter (inches)
2. Pitch (inches)

Propeller types

Abbreviation	Propeller type
WDL	Propeller resistant to fouling
WDR	Wide range, universal propeller

EN

4.2 Controls and components

4.2.1 Travel

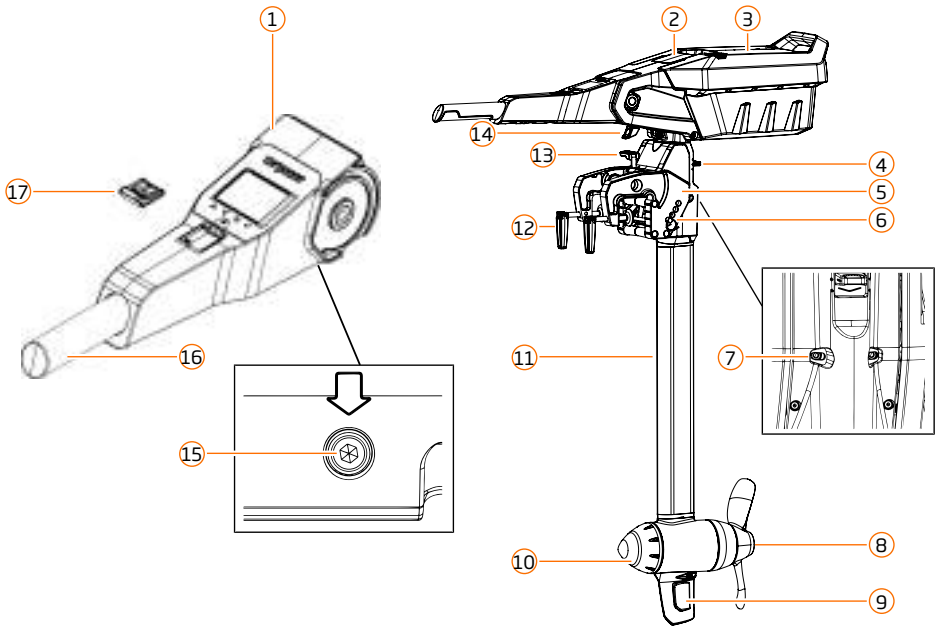

- | | |
|----|----------------------------------|
| 1 | Tiller with display |
| 2 | Battery unlocking |
| 3 | Battery status LED |
| 4 | Steering lock |
| 5 | Transom bracket |
| 6 | Trimming device with 4 positions |
| 7 | Steering resistance setting |
| 8 | Propeller |
| 9 | Removable tiller |
| 10 | Pylon |
| 11 | Shaft |
| 12 | Transom fixing clamping screws |
| 13 | Trim-tilt lever and Auto kick-up |
| 14 | Tiller lock |
| 15 | Tiller resistance setting |
| 16 | Tiller rotary handle |
| 17 | Emergency stop magnetic chip |

4.2.2 Travel remote

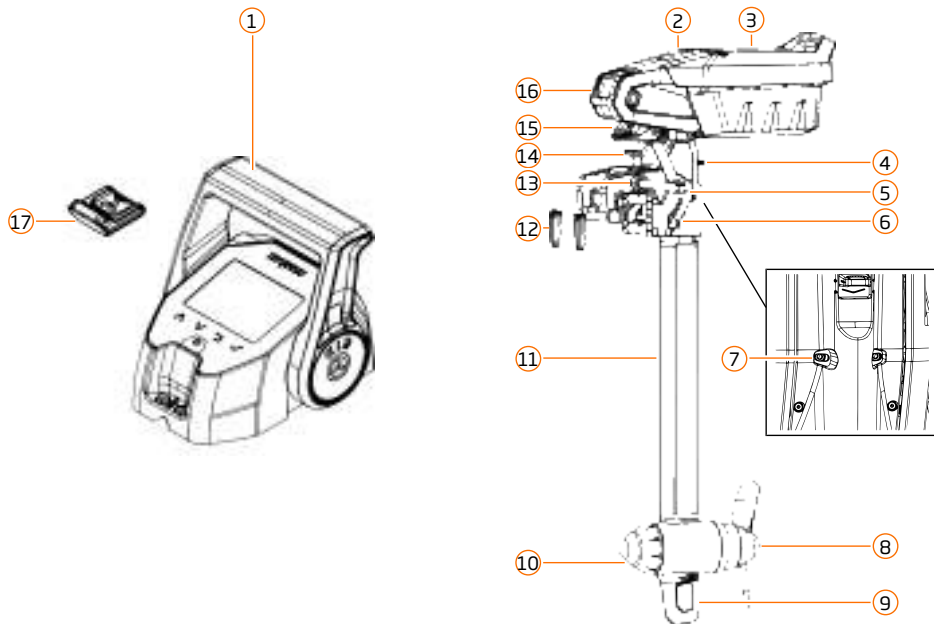

1	Accelerator with display
2	Battery unlocking
3	Battery status LED
4	Steering lock
5	Transom bracket
6	Trimming device with 4 positions
7	Steering resistance setting
8	Propeller
9	Removable tiller
10	Pylon
11	Shaft
12	Transom fixing clamping screws
13	Connecting tube for remote steering
14	Trim-tilt lever and Auto kick-up
15	Connecting rod for remote steering
16	Shaft head cover
17	Emergency stop magnetic chip

4.2.3 Display and buttons

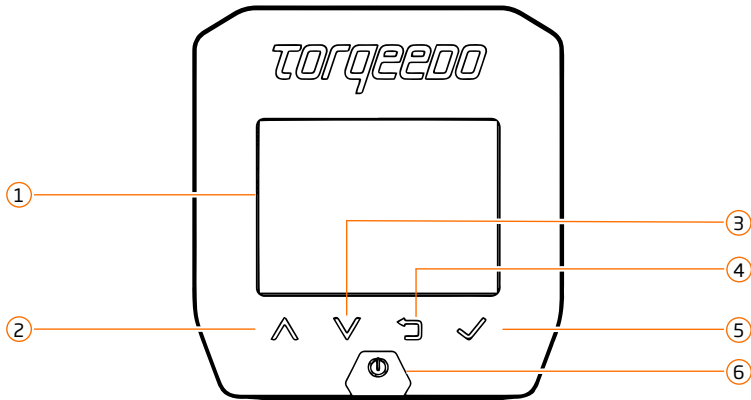

The display and buttons for the tiller and accelerator have the same configuration.

- | | |
|---|------------------------|
| 1 | Display |
| 2 | Scroll up |
| 3 | Scroll down |
| 4 | Back |
| 5 | Confirm / Next |
| 6 | Switch on / Switch off |

4.3 Scope of supply

4.3.1 Motor

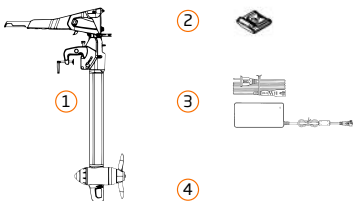

Scope of supply for Travel and Travel XP

1	1x	Motor
2	1x	Emergency stop magnetic chip
3	1x	180W charger
	1x	Operating manual

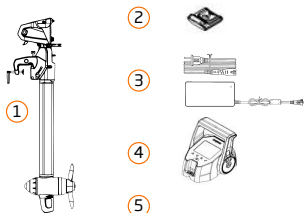

Scope of supply for Travel XP Remote

1	1x	Motor
2	1x	Emergency stop magnetic chip
3	1x	180W charger
4	1x	TorqLink accelerator
	1x	Operating manual

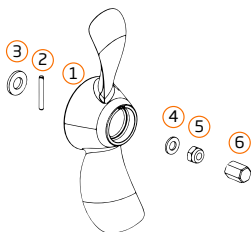

Scope of supply for Travel, Travel XP, Travel XP Remote

1	1x	Propeller Travel - 10x6.5 WDR Travel XP - 11x8 WDR
2	1x	Drive pin
3	1x	Axial pressure disc M14 A4
4	1x	Washer M10 A4
5	1x	Fixing nut M10 A4
6	1x	Shaft anode for motor shaft

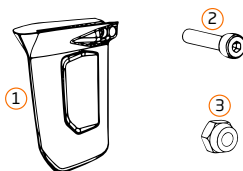

Scope of supply for Travel, Travel XP, Travel XP Remote

1	1x	Fin
2	1x	Screw M4x20A4
3	1x	Nut M4-A4

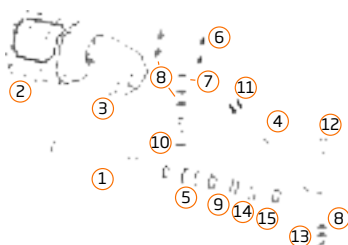

Scope of supply for Travel XP Remote Adapter Kit

1	1x	Steering tube
2	1x	Cover
3	1x	Frame plate
4	1x	Steering plate
5	1x	Bearing bush 22x24x25
6	2x	Screw M10x12-A4
7	1x	Nut M10-A4
8	6x	Washer M10-A4
9	2x	Washer M22-A2
10	1x	Screw M10x25-A4
11	2x	Plastic screw 50x14-A4
12	1x	Locking pin 9.5x22mm
13	1x	Splint 3x25
14	1x	Spring ring A4
15	1x	Nut M22-A4
16	1x	Cable tie

4.3.2 Battery

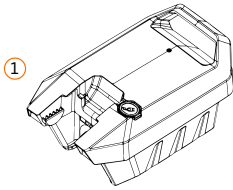

Scope of supply for Travel and Travel XP

1	1x	Travel battery
1	1x	Travel XP battery

4.4 Equipment registration

<https://www.torqeedo.com/service-center>

①



New Product Registration

②



Register your product! There are lots of advantages for you!



Traceability is obligatory for boat drives

As with all boat drives, the Product Safety Act and the Machinery Directive apply to Torqeedo products. These make it obligatory to take measures that allow products and components to be traced in the direction of both suppliers and customers. If any safety information is issued in relation to your Torqeedo product in future, registration will help us to contact you.



Better theft protection: Traceability of serial numbers can help

With the serial number of your product, we can identify your Torqeedo product as your property for any maintenance work, repairs or complaints. We might also be able to help in returning your property to you. All over the world, of course. (Unfortunately, it is not possible to locate stolen outboard motors using the integrated GPS receiver, as the device only receives position data and does not have a transmission function.)



Simply better information

As soon as there are any changes or innovations that affect your product (in development or production, for example), we can contact you individually - if you wish - and make sure that you have all the essential news immediately.

5 Technical information

5.1 Selection of the correct shaft length



TIP! When it comes to selecting the right shaft length, a quick look in the manual for your boat is usually sufficient. The manufacturer often specifies the height of the transom or offers a recommendation for selecting the shaft length.

If you cannot find any information about choosing the shaft length in the manual for your boat, you can proceed as follows:

Measure dimension (A) on your boat and choose the corresponding shaft length.

Dimension (A) is the distance between the upper edge of the motor transom (1) and the lowest point of the keel (2).

①

②

A

Dimension (A)	Recommended shaft length
38cm / 15"	S
51cm / 20"	L

EN

5.2 Technical characteristics

5.2.1 Transom bracket

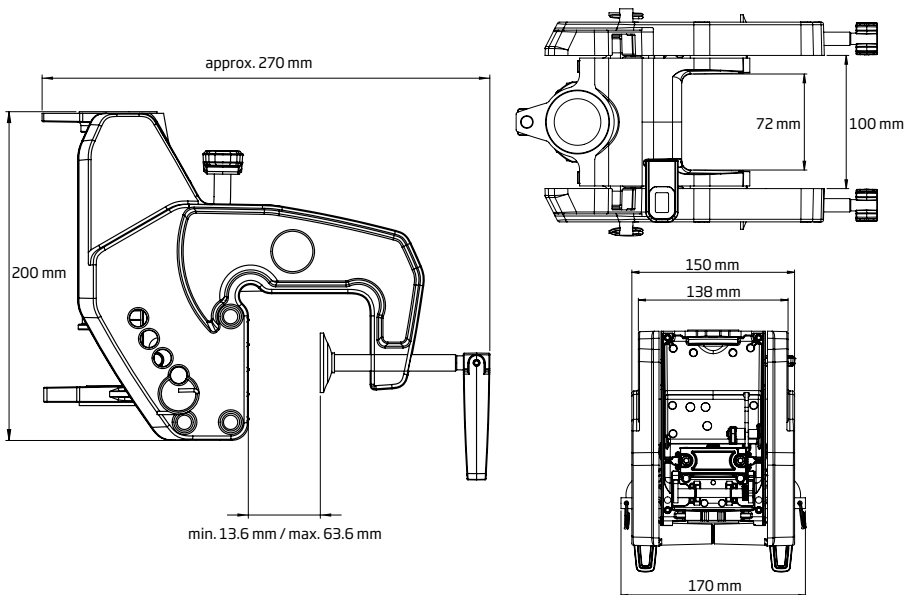

5.2.2 Travel
Travel and Travel XP

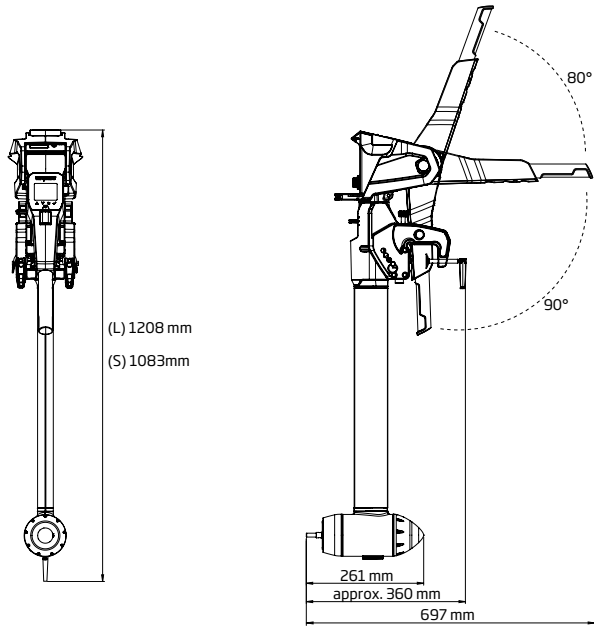

Tiller handle

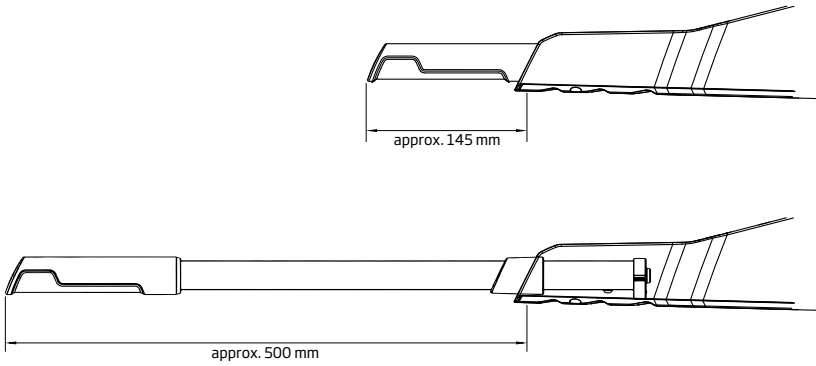

5.2.3 Travel Remote

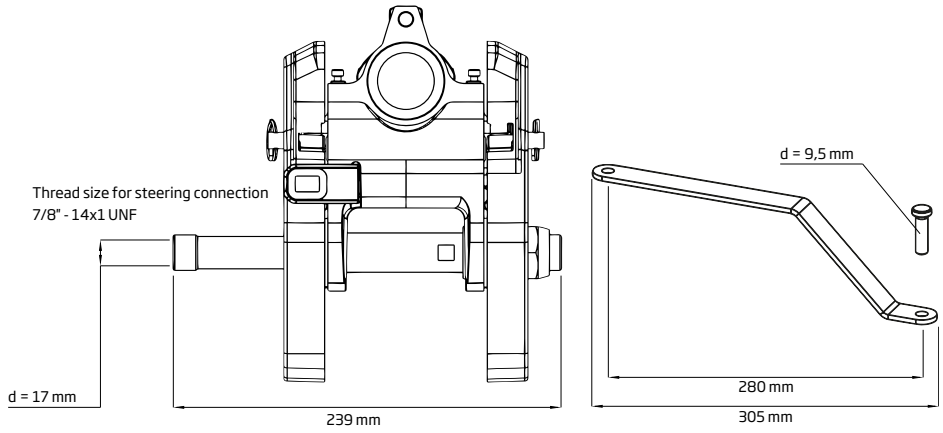

5.2.4 Battery

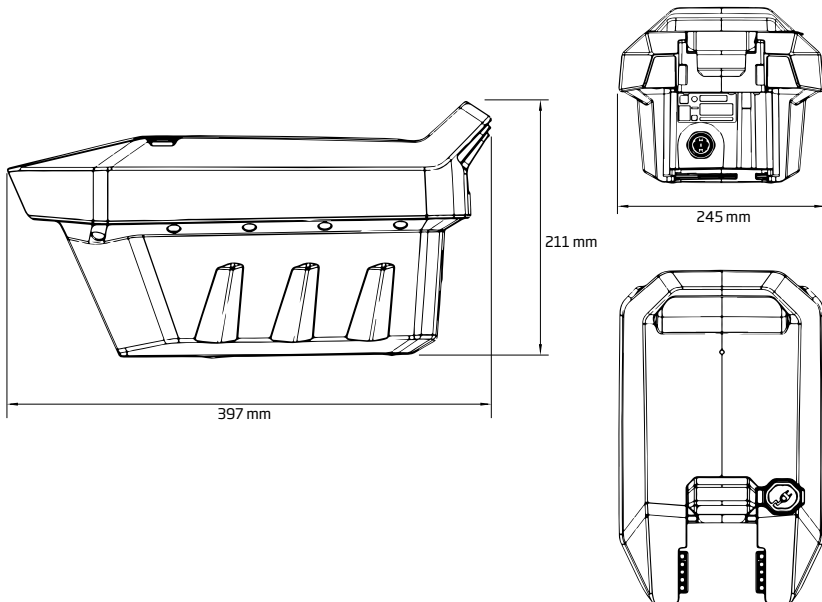

5.3 Operating conditions

5.3.1 Operating conditions for operation

Motor and battery	Travel and Travel XP
Water temperature	-5 °C - +35 °C / 23 °F - 95 °F
Air temperature	-10 °C - +45 °C / 14 °F - 113 °F

5.3.2 Operating conditions for charging

Battery and charger	Travel 1100 and Travel 1600 batteries
Temperature	0 °C - +45 °C / 32 °F - 113 °F

5.3.3 Operating conditions for storage

Motor, battery and accessories	Travel and Travel XP
Storage temperature	-20 °C - +55 °C / -4 °F - +131 °F
Battery charge status	50% SOC

5.4 Technical data

5.4.1 Data and dimensions

Motor	Travel
Continuous input power	1100 W
Nominal shaft power	930 W
Nominal voltage	44 V
Current strength	max. 27.5 A
Motor weight	11.6 kg (S) / 12.0 kg (L)
Recommended battery	Travel Battery
Alternative battery	Travel Battery XP
Shaft length	62.5 cm (S) / 75.0 cm (L)
Standard propeller	Propeller 10x6.5 WDR
Propeller speed	max. 1400 rpm
Operation	Tiller
Steering angle	360 ° / +/- 60 ° / 0 ° fixed
Motor tilt device	Tilt lock / Auto tilt up
Motor tilt angle	max. 90°, 2 positions
Motor trim device	4 positions
Shallow water positions	min. 2, max. 4 (depending on trim position)
Stepless forwards/reverse motion	Yes
GPS / WiFi frequencies	1575.42 MHz / 2412 MHz - 2484 MHz

Motor	Travel XP and Travel XP R
Continuous input power	1600 W
Nominal shaft power	1400 W
Nominal voltage	44 V
Current strength	max. 40.0 A
Motor weight	12.6 kg (S) / 13.0 kg (L)
Recommended battery	Travel Battery XP
Alternative battery	Travel Battery (reduced motor output)
Shaft length	62.5 cm (S) / 75.0 cm (L)
Standard propeller	Propeller 11x8 WDR
Propeller speed	max. 1400 rpm
Operation	Tiller / accelerator
Steering angle	360 ° / +/- 60 ° / 0 ° fixed
Motor tilt device	Tilt lock / Auto tilt up
Motor tilt angle	max. 90°, 2 positions
Motor trim device	4 positions
Shallow water positions	min. 2, max. 4 (depending on trim position)
Stepless forwards/reverse motion	Yes
GPS / WiFi frequencies	1575.42 MHz / 2412 MHz - 2484 MHz

Battery	Travel Battery	Travel Battery XP
Capacity	See type plate	See type plate
Weight	8.6 kg	9.6 kg

Charger unit	180 W charger unit for Travel
Input voltage	100 VAC - 240 VAC
Output voltage	32 VDC
For indoor use only	

5.4.2 Protection class according to DIN EN 60529

Protection class	Components
IP67	Travel, Travel XP, Travel XP Remote
IP67	Travel and Travel XP tiller
IP67	TorqLink accelerator
IP67	Travel Battery, Travel Battery XP
-	Charger unit, for indoor use only
IP67	12V charger cable
IP67	Solar charger cable

5.5 Information about conformity

5.5.1 Declaration of Conformity



Your Torqeedo product has been designed and manufactured with the utmost care and attention to convenience, user-friendliness and safety, and thoroughly tested before delivery. It also meets all the requirements of EU standards. You will find the EU Declaration of Conformity for your product in the Support section of our homepage.

5.6 Patents



The product(s) is/are protected by one or more patents. You will find a list of those patents here:

www.torqeedo.com/us/en-us/technology-and-environment/patents.html

6 Installation and fitting on the boat



WARNING

Rotating components!

These can cause serious cuts.

- Remove the emergency stop magnetic chip and take the battery out of the motor before carrying out any work or inspections on the propeller.
- Make sure that the motor is secured to prevent re-activation when working on it.

EN



CAUTION

Risk of crushing due to uncontrolled tilting of the motor.

This can result in minor or moderate bodily injuries.

- Do not reach into the tilting area of the motor during tilting or trimming.
- Tilt or trim the motor only when it is firmly fitted to a boat.
- Put the steering lock to the 0° position before tilting or trimming to prevent uncontrolled rotation.

6.1 Fitting the propeller

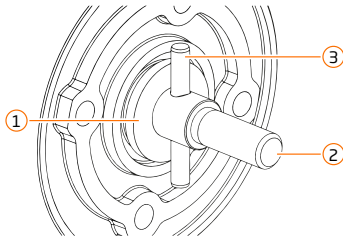

- Position the large axial pressure disc (1) on the motor shaft (2).
- Insert the drive pin (3); ensure that the drive pin is in the centre.

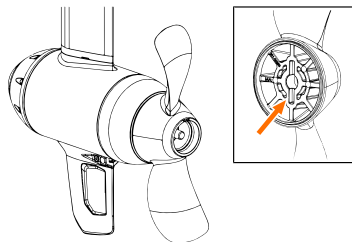

- CAUTION! Risk of cuts!** Wear safety gloves.
- Position the propeller on the motor shaft and push it onto the drive pin.
- Ensure that the drive pin slides into the groove in the propeller (arrow) provided for it.
- Check that the propeller engages on the drive pin.

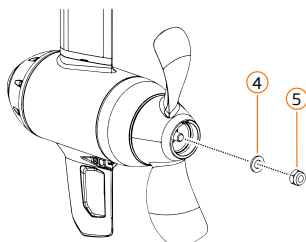

- Position the small washer (4) on the motor shaft.
- NOTICE! Component damage due to thread locking varnish.** Do not use locking varnishes or additives.
- Screw the lock nut (5) onto the motor shaft and tighten it.
- Check that the propeller is moving freely.

NOTICE! Do not apply any thread locking varnish!

- Nut for propeller on motor shaft
Nut M10 A4; SW17; 11 Nm

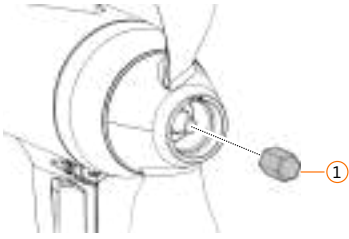

Installing the galvanic anode

- a) Install the galvanic anode (1).

NOTICE! Do not apply any thread locking varnish!

Shaft anode on motor shaft

- Shaft anode; AF 17; 7 Nm

6.2 Fitting the fin

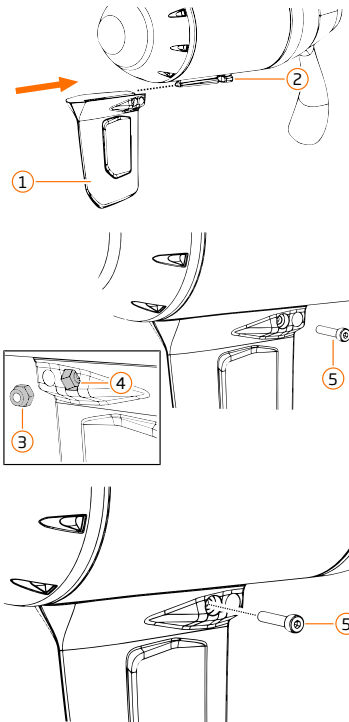

Installation

- a) Push the fin (1) onto the pylon (2).

- b) Insert the nut (3) into the pocket on the fin (4) provided for it.

- c) Insert the screw (5).

- d) Tighten the screw (5).

- Fin on pylon
Cylinder head screw M4x20 A4; Hex socket #3
Nut M4 A4; in fin pocket

6.3 Fitting the motor to the boat

6.3.1 Requirements for fitting to boat

NOTICE! Observe the following points to ensure safe and correct installation of your Torqeedo system:

- Ensure that the boat on which the Torqeedo system is to be installed is secure.
- Boats standing on a trailer must be secured to prevent tipping.
- The boat and all components must be disconnected from electrical power sources.
- The boat, the transom bracket and the condition of the transom bracket must be suitable for operation of the Torqeedo system; observe the manufacturer's specifications for the maximum permissible power (kW) and the maximum permissible weight.
- Use suitable hoisting gear to lift heavy components.

EN

6.3.2 Fitting the motor

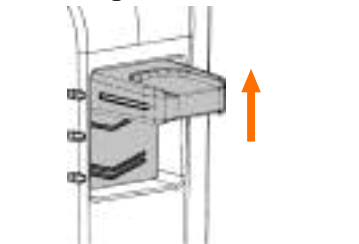

- a) **CAUTION! Risk of crushing!** Do not install the motor with the battery in place.
- a) Ensure that the steering lock switch is in the 0° position to prevent the motor from rotating during installation.



- b) Put the trim-tilt lever into the lock position to prevent the motor from tilting up during installation.



- c) Open the clamp bolts sufficiently wide to allow positioning of the motor on the stern transom of the boat.
- d) Move the tiller into horizontal position until it locks in place.
- e) Position the motor on the transom of the boat.

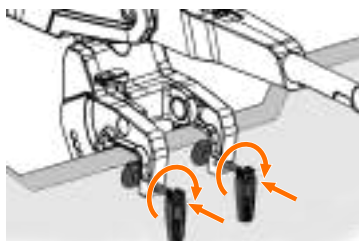

- f) Tighten the transom clamp bolts so that the transom bracket is on the transom and the motor can still be moved.

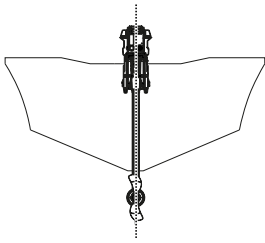

g) Align the motor with the centre line of the boat.

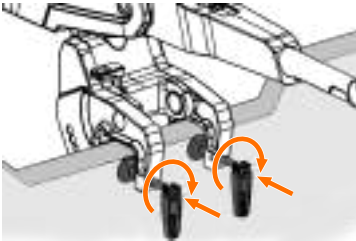

h) Tighten the transom clamp bolts firmly.

i) Make sure that the propeller can rotate freely in any motor position.

a) **WARNING! Ensure that the transom clamp bolts are tightened to prevent the motor from coming away when driving!**

6.4 Installing Remote Adapter Kit

When the Remote Adapter Kit is installed, you can connect a remote steering system to your Torqeedo motor or convert your existing Travel motor with tiller control.

If you have a tiller-controlled motor, you must first dismantle the tiller.

You will find all the information you need to select the right remote steering system for your Travel in the Technical Information.

TIP! With the Remote Adapter Kit, you can connect the remote steering to the motor from both sides. Connection from the right is described here. If you want to fit the remote steering to the left of the motor, you must install the steering tube from the other side.

6.4.1 Installing the frame plate

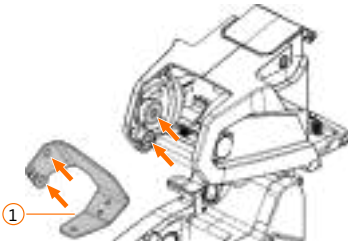

a) Position the frame plate (1) of the Remote Adapter in the shaft head so that the fixing holes are over the corresponding surfaces (arrows).

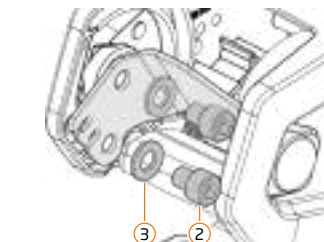

b) Fit the screws (2) and washers (3).

Remote Adapter frame plate on right of shaft head

- Cylinder head screw M10x12; Hex socket #8; 30 Nm

6.4.2 Attaching the data cable

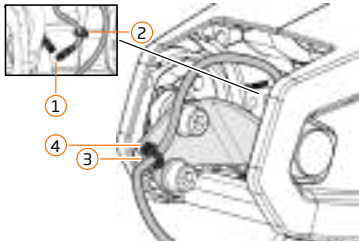

- Connect the plug (1) on the data cable to the motor.
- Attach the fitting clip (2) on the data cable to the appropriate point.
- Position the data cable on the strain relief (3) and fix it with a cable tie (4).

6.4.3 Fitting the cover

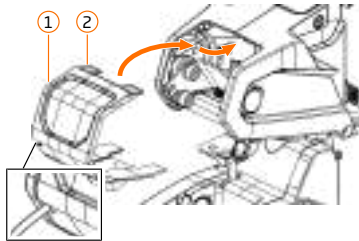

- Position the cover (1) with the lugs (2) in the shaft head and guide the data cable into the groove provided for it as you do so (magnifying glass).

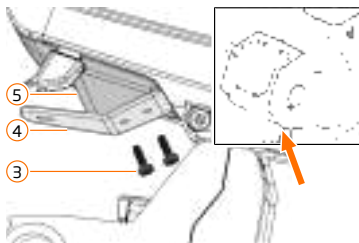

- Insert the screws (3) through the frame plate (4) and screw them into the cover (5).
- NOTICE! Self-tapping screws.** The thread has to be cut on initial fitting. Make sure that the screws are straight as you screw them in.

Cover on frame plate

- Plastic screw PT-50x14; Hex socket #4

6.4.4 Installing the steering tube

TIP! With the Remote Adapter Kit, you can connect the remote steering to the motor from both sides. Connection from the right is described here. If you want to fit the remote steering to the left of the motor, you must install the steering tube from the other side.

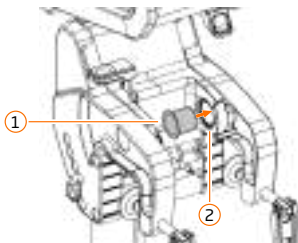

- Insert the bearing bushing (1) into the left transom bracket (2).

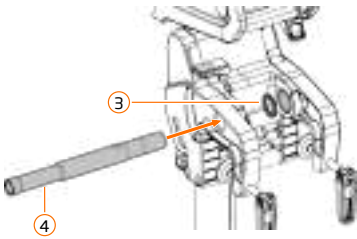

- b) Position the washer (3) over the bushing and guide the steering tube (4) carefully from right to left into the transom bracket with the large thread first.

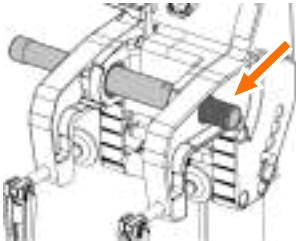

- c) **TIP!** Lubricate the thread of the steering tube with a little universal grease.

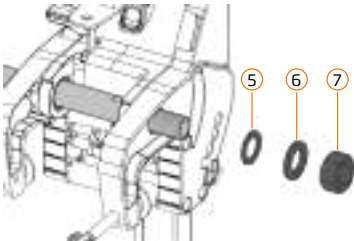

- d) First position the washer (5) over the steering tube, then the locking ring (6) and screw the nut (7) on.

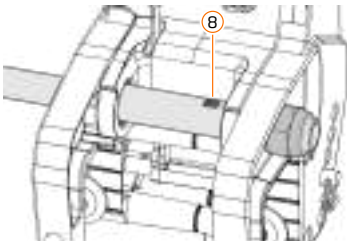

- e) Hold the steering tube by the AF 22 spanner surface (8) and tighten the nut.
 f) **NOTICE! Potential damage to components!** Do not hold the steering tube with pliers.
 g) **NOTICE! Potential damage to components!** Tighten the nut only to the specified torque.

Remote Adapter steering tube on transom bracket

- Nut M22 A4; AF 32; 22 Nm

6.5 Fitting the steering plate

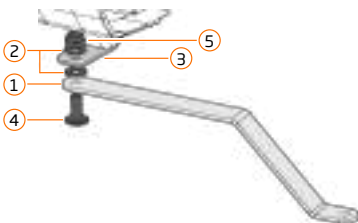

- a) Position the steering plate (1) with the washers (2) on the frame plate (3).
 b) Fit the screw (4) and washer (5).



- c) Loosen the nut by a 1/4 turn after installation.
- d) **NOTICE! Heavy steering!** Check that the steering plate moves freely, loosen the nut by a further 1/4 turn if necessary.

6.6 Connecting the remote steering

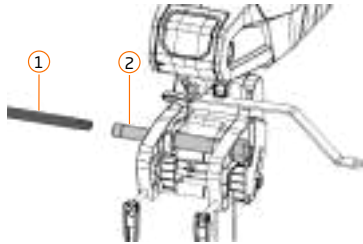

- a) Guide the remote steering (1) into the steering tube (2).
- b) Tighten the nut on the remote steering (3).

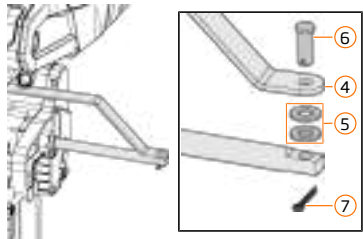

- c) Position the steering plate (4) with the washers (5) on the remote steering and insert the bolt (6).
- d) Insert the locking pin (7) into the bolt and secure it by bending one end up slightly.

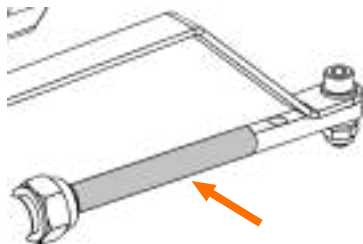

- a) Lubricate the surface of your remote steering (arrow), use a salt water-resistant lubricant if you intend to use the motor in sea water.

6.7 Fitting the accelerator

6.7.1 Fitting the accelerator to the boat

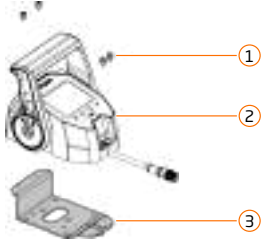

- a) Choose a suitable position for your accelerator.
- b) Remove the screws (1) and separate the accelerator (2) from the fixing plate (3).

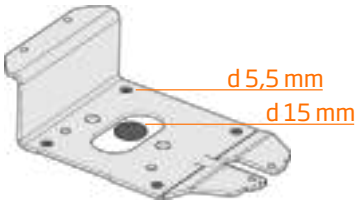

- c) Use the fixing plate as a template to drill the 4x 5.5 mm holes for fitting.
- d) **TIP!** You can lay the data cable either along the front or the bottom.
- e) If you lay the cable along the bottom, you also have to drill the 15 mm hole.
- f) Fit the fixing plate with suitable M5 screws (not supplied). We recommend using sea-water-resistant A4 screws.

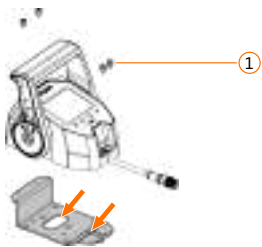

- g) Lay the data cable either under or along the front of the accelerator (arrow) as you prefer.
- h) Position the accelerator on the fixing plate and install the screws (1).

6.7.2 Lay accelerator data cable and connect to motor.

Requirements for laying data cables

Fix the data cable every 400 mm. In places where fixing is not possible, abrasion protection must be fitted to protect the cable sleeve.

Do not group or lay the data cable with cables that carry current or antenna cables; maintain a distance of at least 100 mm to avoid interference.

Observe the minimum bending radius of 64 mm when laying data cables.

Protect connectors and contacts from dirt before fitting.

Do not twist or pull on data cables.

Do not lay the data cable in areas that are always wet, such as bilges.

Lay data cables so that they are not subject to abrasion and do not pass over any sharp edges; fit abrasion protection as necessary.

Ensure that the plug connectors are not under tension or loads.

- a) Connect the accelerator data cable to the extension cable supplied.
- b) Lay the data cable in your boat: observe the requirements for laying data cables.
- c) Connect the data cable to the motor data cable.

6.8 Fitting long tiller arm



CAUTION

Incorrect calibration of the tiller as a result of installation or removal of the tiller handle

Feels different when moving forwards and backwards.

- Use the correct torque.
- Always calibrate after working on the tiller handle.

EN

6.8.1 Remove/install tiller handle

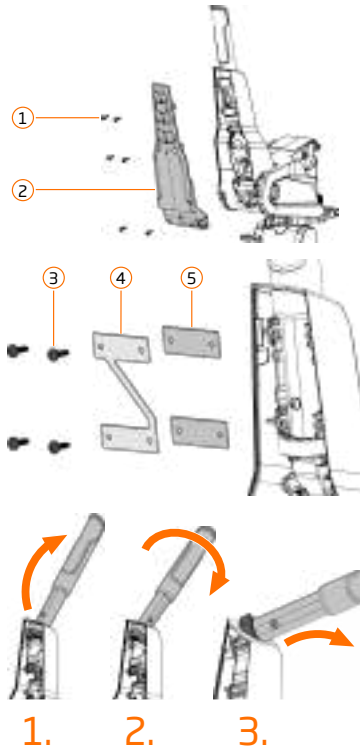

Removing

- Switch off the system and remove the battery.
- Fold the tiller upwards.
- Remove the screws (1) and take off the lower shell of the tiller (2).
- Remove the screws (3) and take off the pressure plate (4) and the pressure pieces (5).
- Remove the tiller handle by carefully threading the tiller handle out of the tiller housing.

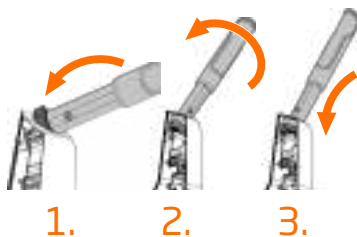

Installation

- Carefully insert the tiller handle into the tiller housing.

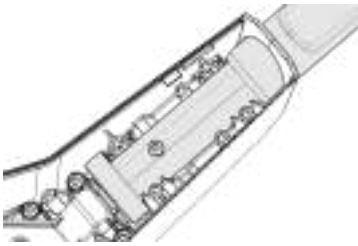

b) Position the tiller handle in the tiller housing.

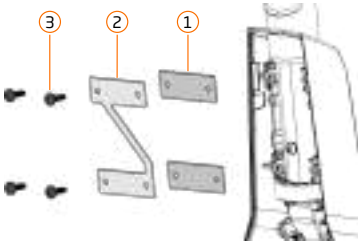

c) Position the pressure pieces (1) with the pressure plate (2) and install the screws (3).

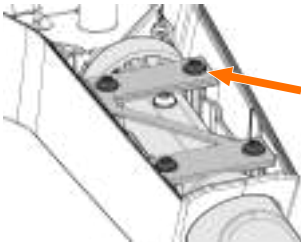

d) Screw in the screws until the pressure plate is aligned (arrow), and then tighten the screws.

NOTICE! Component damage! Tighten the screws to the specified torque.

- Tiller handle pressure plate on upper tiller shell
Plastic screw 4x16 A4, hex socket #20, max. 1.3 Nm

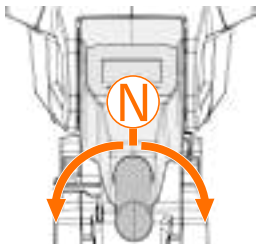

Function check

a) Check the feel of the tiller handle.

- ⇒ It must be possible to turn the tiller handle in both directions, in the neutral position, the tiller handle must engage.

Install lower shell of the tiller

a) Position the bottom shell of the tiller (4) on the tiller housing and install the screws (5).

- Lower tiller shell on upper tiller shell
Plastic screw 4x16 A4, hex socket #20, 1.3 Nm

CAUTION! Incorrect calibration of the tiller! Perform a calibration of the tiller.

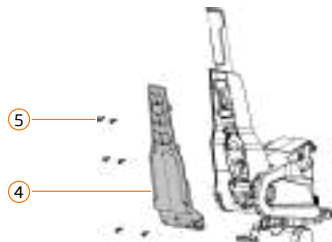

6.8.2 Calibrating the tiller

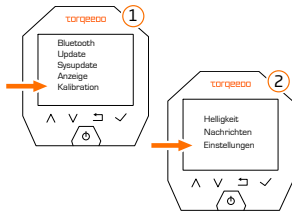

- a) Open the *Calibration* menu (1) - (2).
- b) Follow the instructions on the display.

Main menu - Settings - Calibration

7 Operation

Important information before initial use!

- Before initial use, carry out a software update for all system components.
- Read this manual carefully and make sure you understand it, especially the sections on safety and operation of the product.
- Ensure that the motor and its components are correctly assembled and fitted.

7.1 Software update



An important part of your product is the software. It ensures the correct function of your product and contributes significantly to efficiency, safety and driving behaviour.

Your Torqeedo Team is continually working on improving your system and offers you free software updates for your Torqeedo products for a long period after your purchase.

Keep your system up-to-date and check that you always have the latest version of the software.

You will find the latest software and information about the update process on our homepage.

7.2 Operation in emergency situations

You can stop your Torqeedo motor in several ways in an emergency. The system has appropriate safety features for this purpose. Depending on the model, the system has either an emergency stop magnetic chip on the tiller or on the accelerator. Please note that the type of stop impacts the restart.

Option 1

- a) Move the accelerator lever/tiller to the neutral position to stop the motor.
- ⇒ To continue travelling, you can simply select forward or reverse again.

Option 2

- a) Pull off the emergency stop magnetic chip to stop the motor.
- ⇒ To continue travelling, put the accelerator/tiller into neutral and replace the emergency stop magnetic chip.

Option 3

- a) Switch the motor off with the on/off switch.
- ⇒ The motor switches off.
WARNING! Inability to manoeuvre! The consequence of switching off with the on/off switch is that the system has to be restarted before it can be used again.

Option 4

- a) Pull the battery out.
- ⇒ The motor switches off.
DANGER! Inability to manoeuvre because of damage to components! Pulling out the battery during operation can damage components and thus make it impossible to manoeuvre.

NOTE! Do not use the emergency stop magnetic chip to switch off the system normally, but only if there is an emergency situation.

Battery

The battery of your Torqeedo motor is waterproof in accordance with IP67. This means that it is protected against water penetration at a depth of 1 metre for 30 minutes.

DANGER! Risk of injury! If the battery is at a depth of more than 1 metre or in water for longer than 30 minutes (e.g. if the boat is in an accident), you must comply with the following instructions to avoid personal injury and prevent possible contamination of the environment.

- Do not take any action to bring the battery up to the surface.
- Tell the emergency services that the motor has a lithium battery of protection class IP67.
- Contact Torqeedo to clarify what to do next.

EN

7.3 Transom bracket

7.3.1 Steering lock

Your Torqeedo Travel has an integrated steering lock which allows steering of your motor in three different steering stop positions.

Possible steering lock positions

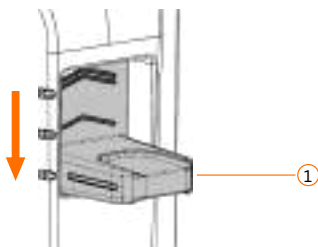

360°

- Set the switch to bottom position (1) to put the steering lock in the 360° position.
- Use this position for maximum manoeuvrability.
TIP! The 360° position is ideal for inserting or removing the battery. Simply rotate the motor 180° and you can access the battery easily.
- WARNING! Inability to manoeuvre!** Depending on the type of remote steering used, the control mechanism may jam. Do not use the 360° position if you are operating your motor with a remote steering system.

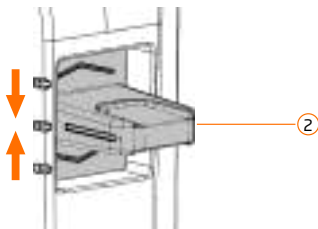

120°

- Set the switch to centre position (2) to put the steering lock in the 120° position.
- Use this position to restrict the steering angle.
NOTE! Use this position if you are operating the motor with a remote steering system.
- TIP!** If you stop frequently and release the tiller, the motor will not turn more than 60° in any direction and the tiller will always remain in reach.

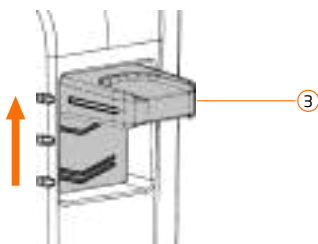

0°

- Set the switch to top position (3) to put the steering lock in the 0° position.
- Use this position to lock the steering to move in a straight line.
TIP! If you set the steering lock to the 0° position to tilt the motor out of the water for a brief stop, the motor will stay straight and take up the smallest space in the boat.

- c) **WARNING! Inability to manoeuvre!** Do not use the 0° position if you are operating your motor with a remote steering system.

7.3.2 Motor tilt device

You can adjust the behaviour of the tilt device on your Torqeedo Travel.

Tilt lock device

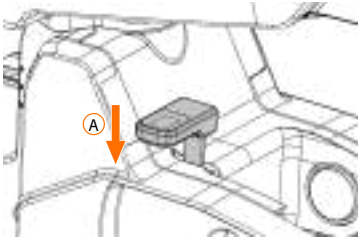

- **Tilt lock is active** when the tilt lock lever is in bottom position (A).
The motor will not tilt upwards, this setting is the default setting for operating the motor.
Use this position in water of sufficient depth and when you want to stop your boat.

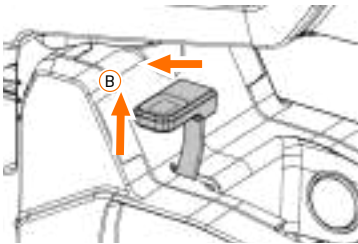

- **Auto tilt up is active** when the tilt lock lever is in top position (B).
The motor tilts upwards.
Use this position if you are moving through shallow water or if you intend to use a shallow water setting.

DANGER! Risk of accident due to restricted manoeuvrability!
Stopping is not possible when using Auto tilt up! Check your boat speed when approaching people, objects and obstacles. Drive slowly!

DANGER! Risk of injury! If you stop in Auto tilt up, the propeller may come out of the water - keep your distance!

Tilting the motor

- a) **CAUTION! Risk of crushing!** Put the steering lock to the 0° position before tilting to prevent uncontrolled rotation of the motor. Do not reach into the tilting area of the motor during tilting.
- b) Pull the tilt lock lever fully upwards and keep it in this position.
- c) Tilt the motor to the required position and move the tilt lock lever back to the lower position.

Activating Auto tilt up

- a) Pull the tilt lock lever fully upwards and then push it back until the lever locks in place.
- ⇒ Auto tilt up is active

Tilt lock

- a) Lift the tilt lock lever slightly and push it forwards until it can be moved down again.
 - b) Move the tilt lock lever back to the lower position.
- ⇒ Tilt lock is active

7.3.3 Shallow water positions

You can choose between up to 4 shallow water settings on your Torqeedo Travel.

The number of shallow water settings depends on the trim position selected.

The shallow water settings allow you to use your motor in shallow waters, e.g. for docking or fishing.

When operating with a shallow water setting, Auto tilt up is always active to prevent damage if you touch the ground.

Please note that a hard stop is not possible with the Auto tilt up function, as the motor then comes out of the water. Drive carefully and look ahead.

Adjusting and closing shallow water setting

a) Put the tilt mechanism into the Auto tilt up position.

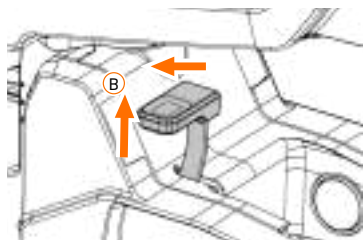

b) Raise the motor until you reach the shallow water setting you require. You can hear when you reach a shallow water setting by the click when the position is reached.

c) Lower the motor and it will lock in position.



d) Tilt the motor fully down to end operation in the shallow water setting.

DANGER! Risk of accident due to restricted manoeuvrability! Stopping is not possible when using Auto tilt up! Check your boat speed when approaching people, objects and obstacles. Drive slowly!

DANGER! Risk of injury! If you stop in Auto tilt up, the propeller may come out of the water - keep your distance!

7.3.4 Tips for trimming the motor

TIP! The optimum trimming position depends on the load on the boat. Make the most of the Torqeedo system's performance and efficiency by adjusting the trimming setting to the load.

Test run

Carry out a test run and observe the behaviour of your boat.

- The bow of the boat rises too high out of the water when moving
- Steering becomes unsteady
- Poor course retention

Move the trim rod downwards.

- The bow of the boat sinks too far down when moving

- The maximum speed decreases.

Move the trim rod upwards.

Optimum trim is achieved when

- the motor shaft is perpendicular to the water surface while driving
- and the waterline of the boat is parallel to the water surface.

7.3.5 Trimming the motor



CAUTION

Risk of crushing due to uncontrolled tilting of the motor.

This can result in minor or moderate bodily injuries.

- Do not reach into the tilting area of the motor during tilting or trimming.
- Tilt or trim the motor only when it is firmly fitted to a boat.
- Put the steering lock to the 0° position before tilting or trimming to prevent uncontrolled rotation.

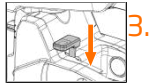
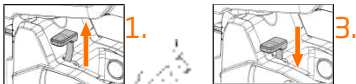

- Move the motor to the lowest shallow water position and move the tilt lock lever back to the "Lock" position.

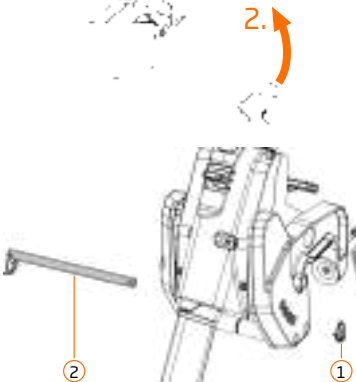

- Remove the ring splint (1).
- The motor engages on the trim rod (2). Lift the motor slightly to make it easy to pull the trim rod out of the transom bracket.
TIP! Use a safety line to avoid losing the ring splint and trim rod.

- Pull the trim rod out of the transom bracket.
- Tilt the motor upwards until you can insert the trim rod in the trim position you require and push it in.
- Fit the ring splint.

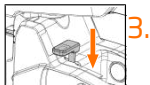

- Tilt the motor down again and put the tilt lock lever into the position required.

7.3.6 Steering brake

You can adjust the steering resistance of your Torqeedo Travel to your preferred setting.

All you need to adjust the setting is a size #4 Allen key.

The steering brake allows you to set the feel and steering behaviour of your motor.

If you are operating your motor with a remote steering system, we recommend setting the steering resistance to the lowest possible value.

Make adjustments to the steering brake only when the motor is fitted to the boat.

NOTICE! Potential damage to components! Do not use the steering brake to lock the motor. If you wish to lock the motor in position, use the 0° steering lock instead.

INFORMATION! Your motor is supplied with the steering brake in its default setting. If you are operating your motor with a remote steering system, we recommend adjusting the setting on installation.

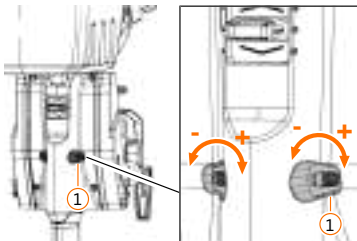

Setting the steering brake

- Use a size #4 Allen key.
- Turn the two screws on the steering brake (1) evenly anticlockwise to increase the steering resistance.
- Turn the two screws on the steering brake anticlockwise to reduce the resistance.
- NOTICE! Potential damage to components!** Unscrew the two screws only to the point at which you cannot feel any resistance from the steering. Do not unscrew the screws completely under any circumstances, as you will not be able to screw them back in again.

7.4 Tiller

7.4.1 Tiller lock and resistance

With the tiller lock, you can lock the tiller in the default position for operation or fold it down for storage or a period out of use.

The tiller can also be adjusted upwards, thereby allowing it to be used when you are standing, for example.

With the setting screw for the tiller resistance, you can adjust the behaviour of the tiller in returning to the default position. For example, you can adjust the resistance so that the tiller remains in position when it is adjusted upwards or set it so that it returns to the default position automatically.

You need a size #4 Allen key to adjust the setting.

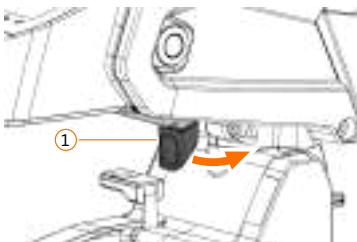

Using the tiller lock

- Move the lever (1) to fold the tiller down.
- Move the tiller up until it locks in default position.

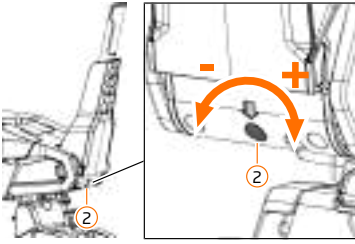

Setting the tiller resistance

- Move the tiller up.
- Use a size #4 Allen key.
- Turn the setting screw (2) clockwise to increase the resistance.
- Turn the setting screw anticlockwise to reduce the resistance.
- NOTICE! Potential damage to components!** Unscrew the setting screw only to the point at which you cannot feel any resistance. Do not unscrew the screw completely under any circumstances, as you will not be able to screw it back in again without opening the tiller housing.

7.5 On-board computer

7.5.1 Operation and membrane keyboard

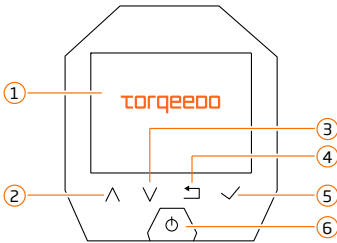

- Display
- Scroll up
- Scroll down
- Back
- Confirm / Next
- Switch on / Switch off

7.5.2 Main screens

You will find all the data that is important for your trip on the display of your Torqeedo Travel. You can choose between 3 variants and the charging screen and adapt them to your needs, e.g. by changing the measurement units.

When the battery charge is low, warnings are displayed on the main screen. The colour of the warnings and the "Battery charge" display depend on the SOC.

- SOC > 10% no warnings.
- SOC < 10% is displayed by a yellow warning
- SOC < 3% is displayed by a red warning

If there are important or critical pieces of information or error messages, the warnings are shown directly on the display. Follow the system prompts to ensure system and operational safety.

Main screen 1

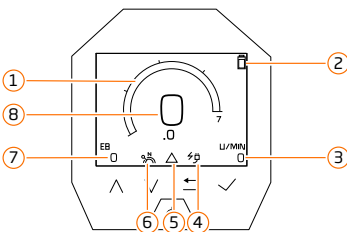

- Current speed (SOG)
- Battery charge (SOC)
- Revolutions per minute
- Charge display
- Error messages
- Neutral position
- Current output of the motor in watts
- Current speed (SOG)

Main screen 2

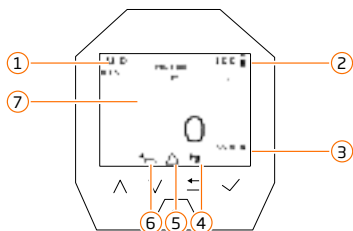

1. Current speed (SOG)
2. Battery charge (SOC)
3. Revolutions per minute
4. Charge display
5. Error messages
6. Neutral position
7. Current output of the motor in watts

Main screen 3

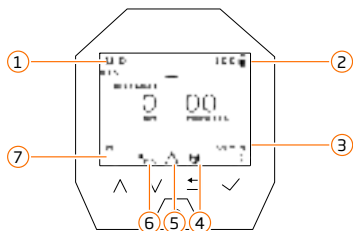

1. Current speed (SOG)
2. Battery charge (SOC)
3. Revolutions per minute
4. Charge display
5. Error messages
6. Neutral position
7. Current output of the motor in watts

Charge screen

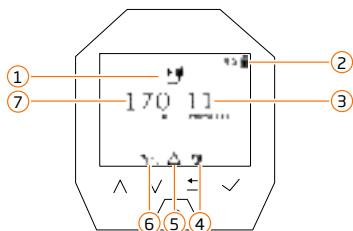

1. Charge screen display
2. Battery charge (SOC)
3. Time until charging complete
4. Charge display
5. Error messages
6. Neutral position (visible only when the motor is switched on)
7. Current charging power in watts

7.5.3 Brightness

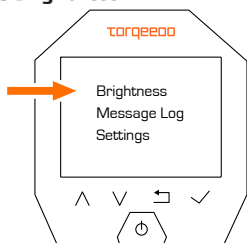

a) Navigate to the menu.

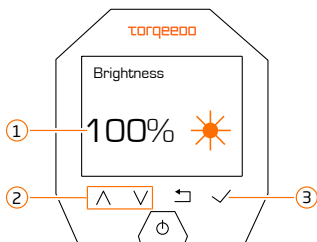

- ✓ The brightness (1) is displayed.
- a) Use the buttons (2) to adjust the brightness.
- b) Select the button (3) to confirm your input.

7.5.4 Messages

All current messages and errors are displayed on the Messages menu.

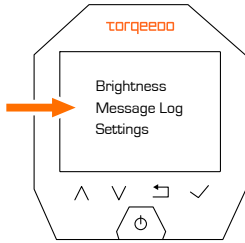

a) Navigate to the menu.

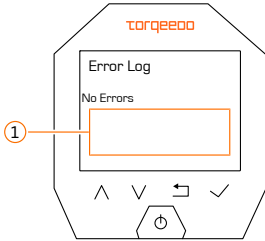

Current messages and errors are displayed in the area (1).

7.5.5 Bluetooth and Bluetooth password

On the Bluetooth menu, you can switch Bluetooth on and off and change your Bluetooth password.

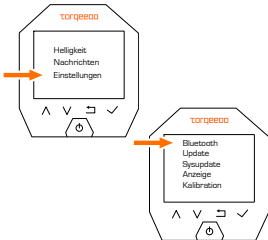

Switching Bluetooth on / off

a) Navigate to the menu.

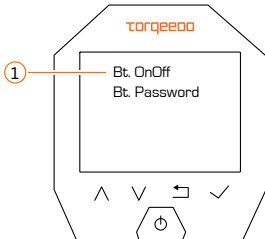

a) Select (1) to switch Bluetooth on or off.

b) Restart the motor.

⇒ The setting required becomes active on restart.

Viewing and changing the password

- a) Navigate to the menu.

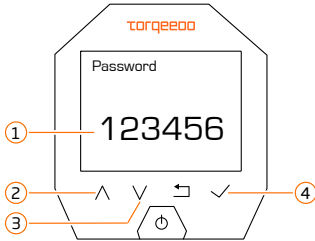
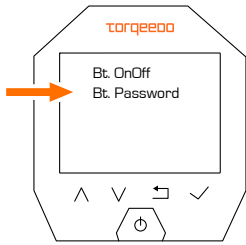

The current Bluetooth device password (1) is displayed.

- a) Use the button (2) to change the numerical value of the highlighted digits.
- b) Use the button (3) to change to switch to the next digit.
- c) Select the button (4) to save the new Bluetooth password.

7.5.6 Settings

TIP! The software for your motor is continuously under development; you will find the latest version on our homepage.

The following section describes the items on the *Settings* menu.

- | | |
|-------------|---|
| Bluetooth | <ul style="list-style-type: none"> • Switching Bluetooth on and off • Choosing a Bluetooth password • Viewing the Bluetooth password |
| Sysupdate | <ul style="list-style-type: none"> • Carrying out a system update |
| Display | <ul style="list-style-type: none"> • Changing units • Adjusting presentation of maximum output • Adjusting presentation of maximum speed |
| Calibration | <ul style="list-style-type: none"> • Setting and calibrating forward and reverse |
| Info | <ul style="list-style-type: none"> • Serial number • Software version • GPS status |
| Status | <ul style="list-style-type: none"> • Access information about system status (mode for Torqeedo service partners) |
| Language | <ul style="list-style-type: none"> • Select language |

7.6 Battery and charger

The battery of your Torqeedo Travel has a battery management system (BMS). While the battery cells store the energy, the BMS ensures that the battery cells remain in equilibrium. The BMS continuously monitors the charging process during charging and throughout the discharge process in operation. The BMS also monitors other parameters of the battery, such as its temperature. Based on these parameters, it controls the charging and discharge processes to achieve maximum power, safety and lifetime for your battery.

In addition, the BMS has a derating program which adapts your system to the system status during use. For example, the system lowers the maximum available output if certain charge states or temperatures are reached, in order to provide you with maximum range and safety.

The battery status LED indicates the status of the battery. You can see the status and charge level of the battery at a glance from it. Any errors and faults that occur are also indicated by it.

7.6.1 Charging the battery

The battery of your Torqeedo Travel can be charged in several ways. The following section describes the use of the standard charger; however, connection to the battery is the same for any charger, charging cable or solar panel that Torqeedo offers for your product.

You also have the option to charge the battery during operation to increase its range. Please note, however, that the standard charger is intended for indoor use only. Use a charging option that is designed for the environmental conditions that may affect it, e.g.:

- 12V charging cable, 7011-00
- Solar charging cable, 7008-00

These cables meet the necessary protection class and safety requirements for charging your battery reliably in a maritime environment.

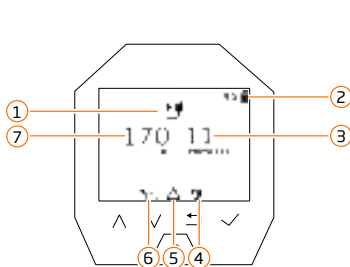

Charge screen

1. Charge screen display
2. Battery charge (SOC)
3. Time until charging complete
4. Charge display
5. Error messages
6. Neutral position (visible only when the motor is switched on)
7. Current charging power in watts

Behaviour of the motor and charging screen

- **Motor on** when starting the charging process, the motor remains on at the end of charging.
- **Motor off** when starting the charging process, the motor switches off at the end of charging.
- **Motor is switched on during the charging process**, the motor remains on at the end of charging.
- **Motor is switched off during the charging process**, the motor switches off at the end of charging.

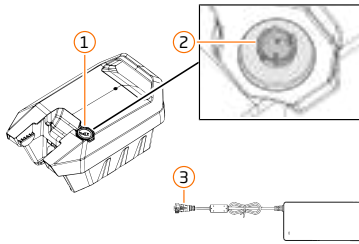

Connecting the charger

- DANGER! Potential injury due to improper use!** Only use the standard charger supplied indoors and on a heat-resistant surface.
- Remove the sealing cap (1) on the charging connection (2).
- Position the charging plug (3) of the charging cable over the charging connection so that the markings align.
- Push the charging plug in and rotate it 45° until it locks.
 - ⇒ The charging process starts, the battery status LED begins to indicate the charge level.

Charging during operation

- NOTICE! Battery charging not possible!** Follow the sequence of steps for connecting the charger.
- First insert the battery into the motor.
- Then connect the charger.
 - ⇒ The charging process starts, the battery status LED begins to indicate the charge level.

7.6.2 Battery status LED

The battery of your Torqeedo Travel has a battery status LED.

You can see the status and charge level of the battery at a glance from it. Any errors and faults that occur are also indicated by it.

The current status is displayed and described by:

- The colour of the battery status LED
- Its behaviour - steady light, flashing, pulsing
- Speed of flashing and speed of pulsing

The charge level of your battery is given as the SOC (state of charge).

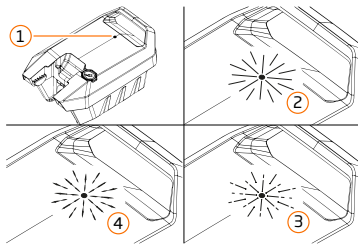

- Battery status LED - off
- Illuminated
- Flashing
- Pulsing

Driving

Display	Status
Green light on	> 75% SOC
Green light flashing	75% SOC
Green light flashing	50% SOC
Yellow light on	25% SOC
Yellow light flashing	10% SOC
Red light flashing	0% SOC

Charging

Display	Status
Green light pulsing	> 25% SOC
Yellow light pulsing	25% SOC
Red light pulsing	10% SOC

Storage / Standby

Display	Status
Off	Storage

Error / Fault

Display	Status
Red light on	Defect
Red light flashing	Error

Service

Display	Status
White light on	NOTICE! Do not disconnect battery!

7.6.3 Inserting the battery into the motor and removing it

Your Torqeedo Travel can be made ready for a trip very quickly. The battery makes contact itself when it is inserted into the motor and is ready to use when you switch on.

Charge the battery before every use in order to achieve maximum range.

The charge status of the battery is shown on the display; when you start the motor, it can take a few seconds for the system to determine the charge status and display it.

Your motor has a sealing cap to seal the hybrid plug against the weather when it is not in use. The hybrid plug is the plug connection that connects your motor to the battery; on the one hand it supplies power to the motor, on the other it facilitates the data communication between the motor and the battery.

Inserting the battery into the motor



WARNING

Risk of injury due to damaged battery housing and escaping electrolytes!

Chemical reactions, risk of fire and caustic burns can result.

- Check the housing and battery guides for damage, breaks or deformation before every use.
- Do not use or charge the battery if you see any damage during your check.
- Contact Torqeedo and notify Torqeedo Service about the damage.

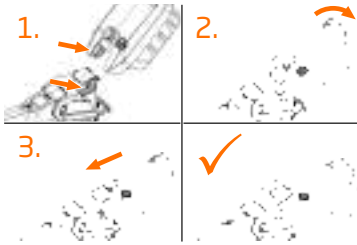

- a) **TIP!** Put the steering lock into the 360° position and turn the motor so that you can access the battery easily and safely.
 - b) Position the battery at an angle, insert it into the corresponding guides (arrow) and allow it to tilt down carefully.
 - c) Push the battery forward until it locks in place.
- ⇒ You can now switch the motor on.

Removing the battery from the motor

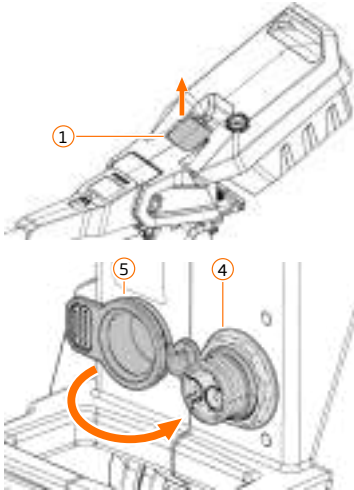

- a) Switch the motor off.
- b) **TIP!** Put the steering lock into the 360° position and turn the motor so that you can access the battery easily and safely.
- c) Pull the handle on the battery unlocking mechanism (3) upwards and push the battery back.
- d) Lift the battery by the battery handle and take it out.
- e) Seal the hybrid plug (4) with the sealing cap (5) to prevent penetration of water and dust.

7.7 Before setting off



Observe the following points every time you use your Torqeedo system to ensure a safe trip.

- Familiarise yourself with the travel area before setting off, as the range shown on the onboard computer does not take into account wind, current and direction of travel, and plan a sufficient buffer for the required range.
- If there is visible damage to components or cables, the system must not be switched on.
- Ensure that everyone on board is wearing a lifejacket.
- Always have the necessary safety equipment ready (anchor, paddle, means of communication, etc.).
- Attach the emergency stop magnetic pin lanyard to the skipper's wrist or lifejacket before setting off.
- The battery charge must be checked at all times while on the move.
- Only apply the emergency stop magnetic chip when there is no one in the water (e.g. after bathing breaks), or remove it immediately if people fall into the water to stop the drive.

- Also observe all information in the “Safety” and “Before use” sections.
- Ensure that you have the latest version of the software at regular intervals and carry out an update if necessary.

7.8 On return



Observe the following points after every use of your Torqeedo system.

- Set the tiller handle to the neutral position.
- Remove the emergency stop magnetic chip and keep it safe so that only authorised persons have access to it.
- **NOTICE! Flat battery!** Switch the motor off.
- Seal the hybrid plug with the sealing cap to prevent penetration of water.
- Charge the battery after a trip if the charge level is below the recommended value.
- Tilt the motor out of the water. **TIP!** For the best protection against UV radiation and other weather, it is advisable to disassemble the motor if it is not to be used for an extended period and to store it in a safe place.
- Flush out the motor with fresh water if you have used it in salt or brackish water.

7.9 Driving

Your Torqeedo system is designed for maximum convenience in operation. Its use is intuitive and you can move forwards and backwards simply by pushing the tiller handle or accelerator lever in the corresponding direction.

The emergency stop magnetic chip fulfils an important safety function. It stops the motor immediately in an emergency or if you fall overboard. You should therefore ensure that the emergency stop magnetic chip is attached to the skipper's wrist or life jacket before setting off.

To adjust the system better to your needs, you can set the direction of rotation for forward and reverse travel.

Before setting off for the first time, familiarise yourself with the direction of rotation; if necessary, you can set / calibrate this yourself on the menu.

EN



WARNING

Risk of injury due to damaged battery housing and escaping electrolytes!

Chemical reactions, risk of fire and caustic burns can result.

- Check the housing and battery guides for damage, breaks or deformation before every use.
- Do not use or charge the battery if you see any damage during your check.
- Contact Torqeedo and notify Torqeedo Service about the damage.



WARNING

Motor may come loose when driving if fixing is defective!

This can cause serious injuries.

- Before setting off, always ensure that the toggle screws on the motor fitting are tightened correctly.
- WARNING! Inability to manoeuvre!** Make adjustments only if you and your boat are safely in harbour.
- Switch the Torqeedo system on.
- Set the tiller / accelerator lever to the neutral position.
- Put the emergency stop magnetic chip in place, make sure the emergency stop magnetic chip is connected to the skipper.
- Turn the tiller / accelerator lever in the appropriate direction.

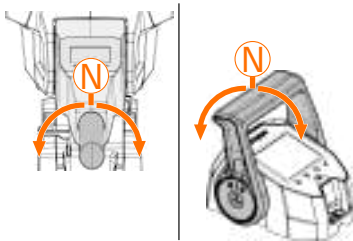

DANGER! Risk of accident due to restricted manoeuvrability!

Stopping is not possible when using Auto tilt up! Check your boat speed when approaching people, objects and obstacles. Drive slowly!

DANGER! Risk of injury! If you stop in Auto tilt up, the propeller may come out of the water - keep your distance!

NOTICE! Component damage due to high mechanical load!

Tilt your motor out of the water if it is not the means of propulsion (e.g. under sail).

8 Storage and transport

8.1 Towing the boat with the motor fitted



NOTICE

Towing the boat on a trailer with the motor fitted is not permitted

The motor must not be fitted to the transom when towing on a trailer and positioning on a slipway.

- a) Disassemble the motor.

8.2 Transport and shipping

Ensure that you meet local regulations when transporting or shipping the motor, battery or other components. If you wish to transport your motor by plane, check the specific regulations with the airline in advance - specifically those that apply to transporting batteries.

TIP! With the Torqeedo bag set (item no. 7009-00), you can transport and store your Torqeedo motor conveniently.

Observe the following points to avoid injury and to protect your Torqeedo motor from damage during transport.

Transporting the motor

CAUTION! Potential injury! Do not hold the motor by the propeller.

- Disconnect the battery from the motor to transport it.
- Clean the motor.
- Move the tiller down to the park position as necessary.
- Put the tilt mechanism into the tilt lock position.
- Put the steering lock in the 0° position.

TIP! Keep the original packaging so that you can ship the motor or battery safely (e.g. for service or repair purposes).

Transporting the battery

DANGER! Potential risk of injury! Do not send or transport damaged batteries; contact Torqeedo to confirm how to proceed.

- Charge or discharge the battery to a charge level of 50% SOC.
- Observe the local regulations for the transport of batteries that apply to you.
- Ensure that the battery cannot be damaged during transport.

8.3 Storage of the battery

The battery of your Torqeedo Travel is equipped with the latest technology. To maintain the efficiency and service life at the highest level reliably and permanently, you simply have to follow a few easy steps when using and storing the battery.



DANGER

Risk of fire due to overheating of the battery!

This can result in burns.

- a) Do not store batteries in hot conditions, e.g. in a vehicle in summer.
- b) Ensure you comply with the operating and storage specifications.

- Store your battery at the optimal temperature: +5 °C - +15 °C / 41 °F - 59 °F
- Charge or discharge the battery to a charge level of 50% SOC.
- Only charge the battery from 50% SOC to 100% SOC immediately before use.
- Charge the battery after a trip and do not store it at a low charge level.
- Check the charge status every 3 months and charge the battery up as necessary.

EN

9 Care, maintenance and repair

Qualification of the user

Repairs and maintenance not described in this operating manual may only be carried out by qualified and certified technicians from Torqeedo Service or a Torqeedo service partner. Servicing must be carried out at the specified intervals or after the specified operating hours by Torqeedo Service or by a Torqeedo service partner. Failure to carry out or document the prescribed maintenance intervals invalidates the warranty and guarantee. Make sure that the maintenance carried out is documented.

9.1 Maintenance and service intervals

Before each use	Visual inspection of the entire system for damage
After each use	Rinse the motor with fresh water
Monthly	Treat all contacts with contact spray
Every 3 months	Check battery charge status and charge up as necessary
Every 6 months or after 100 operating hours	Visual inspection of the galvanic anodes, replace as necessary (in sets)
Every 5 years	Replacement of the shaft sealing rings and O-rings of the pylon by a Torqeedo service partner

9.2 Care



WARNING

Rotating components!

These can cause serious cuts.

- Remove the emergency stop magnetic chip and take the battery out of the motor before carrying out any work or inspections on the propeller.
- Make sure that the motor is secured to prevent re-activation when working on it.

9.2.1 Cleaning

NOTICE! Component damage due to excessive water pressure! Do not clean the motor with high-pressure cleaners.

Cleaning after each trip

- Rinse the motor with fresh water after each use if you have used it in salt water.

Cleaning the system components

- Rinse the motor with fresh water before cleaning.
- Clean the motor only with PH-neutral plastic cleaners and follow the manufacturer's instructions for use.
- Clean other components only with PH-neutral plastic cleaners and follow the manufacturer's instructions for use.
- Do not apply excessive pressure to the display.
- Dispose of cleaning agents in an environmentally friendly way.

9.2.2 Corrosion protection

The materials selected have a high degree of corrosion resistance. Most of the materials used are classified as “sea water resistant”, as is usual for maritime products in the leisure sector, not as “sea waterproof”.

Follow the points below for optimum protection of your Torqeedo system against corrosion:

- Tilt the motor upwards to take it out of the water.
- Flush out the motor with fresh water if you have used it in salt or brackish water.
- Check the galvanic anodes regularly and replace as necessary.
- Store the motor only in dry conditions.
- Regularly maintain all electrical contacts and plug connections.
- Observe the points in the sections “Maintenance, care and repair” and “Service intervals”.

EN

9.3 Maintenance and repair



WARNING

Rotating components!

These can cause serious cuts.

- a) Remove the emergency stop magnetic chip and take the battery out of the motor before carrying out any work or inspections on the propeller.
- b) Make sure that the motor is secured to prevent re-activation when working on it.



CAUTION

Risk of crushing due to uncontrolled tilting of the motor.

This can result in minor or moderate bodily injuries.

- a) Do not reach into the tilting area of the motor during tilting or trimming.
- b) Tilt or trim the motor only when it is firmly fitted to a boat.
- c) Put the steering lock to the 0° position before tilting or trimming to prevent uncontrolled rotation.

9.3.1 Anodes

Your Torqeedo Travel motor has 4 anodes, 3 on the transom bracket and one shaft anode on the motor shaft of the pylon.

The anodes are an important part of the corrosion protection concept for your motor. The specially selected material allows the anodes to protect your motor by sacrificing themselves. You can recognise that this process is taking place by the fact that the anodes dissolve; this process is entirely normal and not a cause for concern. In order to ensure ongoing protection of your motor, you must replace the anodes from time to time. You can identify an anode that needs replacing by the fact that 50% - 75% of the original material has dissolved.

Check the anodes regularly and replace them as necessary.

Replace the anodes in your motor in good time to prevent corrosion.

General information about replacing anodes

- Anodes must have an electrical connection to the component that you want to protect. Do not therefore use thread locking varnish or similar, as this can impair the electrical connection or, in the worst case, interrupt it.
- Do not replace the fixing screws: they are made of aluminium and play an important part in ensuring that the anode has good electrical contact with the component to be protected.
- The contact surface for the anode must be clean, dry and free of oxidation before a new anode is fitted.
- Always replace the anodes as a set.
- Check whether the anodes need replacing every 6 months or every 100 operating hours.
- Make a note of the replacement of the anodes in your boat's log book.

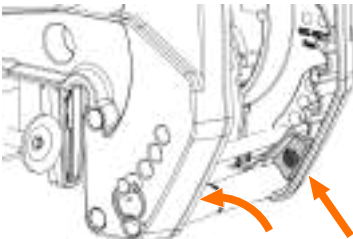

Position of the anodes on the transom bracket

(Arrow) Anodes on the jaws of the transom bracket.

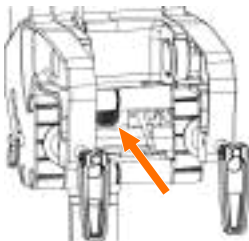

(Arrow) Anode on the swing arm of the transom bracket.

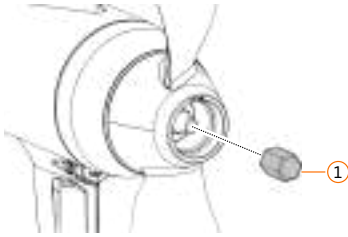

Position of the anode on the pylon

(1) Shaft anode on the motor shaft.

9.3.2 Replacing the propeller shaft anode

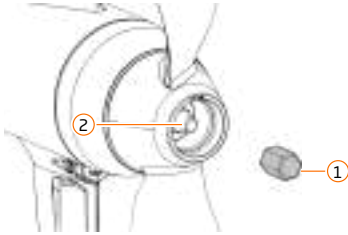

- a) Remove the anode (1).
- b) Clean the motor shaft (2).
- c) Fit the new anode.

NOTICE! Do not apply any thread locking varnish!

Shaft anode on motor shaft

- Shaft anode; AF 17; 7 Nm

9.3.3 Replacing the transom bracket anode

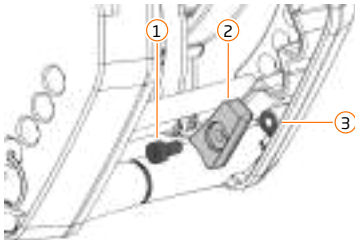

- a) Set the motor to the top tilt position.
- b) Remove the screw (1) and take out the anode (2).
- c) Clean the contact surface (3).
- d) Position the new anode on the contact surface and fit the screw.

- **NOTICE! Do not apply any thread locking varnish!**
- **NOTICE! Aluminium screw! Do not replace screw!**
- **NOTICE! Clean thread**
- **NOTICE! Clean contact surfaces**
- **NOTICE! Check condition of the anode, replace if necessary**

Anode on the transom bracket jaws

- Aluminium screw M5x10 AL; hexagon socket # 4; 2.8 Nm

9.3.4 Replacing the transom bracket ring anode

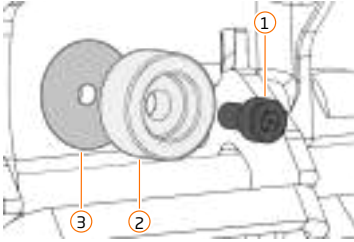

- Set the motor to the top tilt position.
- Remove the screw (1) and take out the anode (2).
- Clean the contact surface (3).
- Position the new anode on the contact surface and fit the screw.

- NOTICE! Do not apply any thread locking varnish!**
- NOTICE! Aluminium screw! Do not replace screw!**
- NOTICE! Clean thread**
- NOTICE! Clean contact surfaces**
- NOTICE! Check condition of the ring anode, replace if necessary**

Anode on the transom bracket

- Aluminium screw M5x10 AL; hexagon socket # 4; 2.8 Nm

9.3.5 Propeller

9.3.6 Removing the propeller

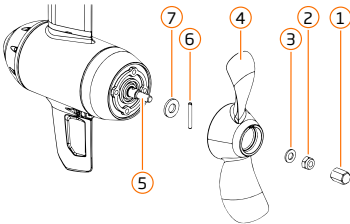

- CAUTION! Risk of cuts!** Wear safety gloves.
- Remove the shaft anode (1).
- Remove the nut (2) and washer (3).
- Pull the propeller (4) off the motor shaft (5).
- Pull the drive pin (6) and the axial pressure disc (7) from the motor shaft and keep them safe.
- Check the motor shaft for foreign bodies, e.g. fishing line, etc.

9.3.7 Fitting the propeller

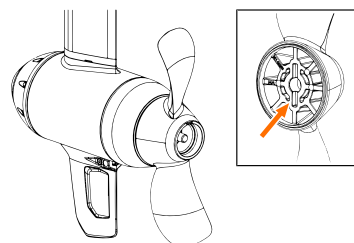
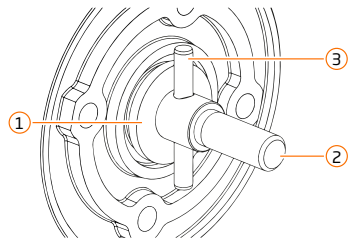

- Position the large axial pressure disc (1) on the motor shaft (2).
- Insert the drive pin (3); ensure that the drive pin is in the centre.
- CAUTION! Risk of cuts!** Wear safety gloves.
- Position the propeller on the motor shaft and push it onto the drive pin.
- Ensure that the drive pin slides into the groove in the propeller (arrow) provided for it.
- Check that the propeller engages on the drive pin.

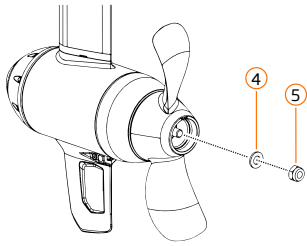

- g) Position the small washer (4) on the motor shaft.
- h) **NOTICE! Component damage due to thread locking varnish.** Do not use locking varnishes or additives.
- i) Screw the lock nut (5) onto the motor shaft and tighten it.
- j) Check that the propeller is moving freely.

NOTICE! Do not apply any thread locking varnish!

- Nut for propeller on motor shaft
Nut M10 A4; SW17; 11 Nm

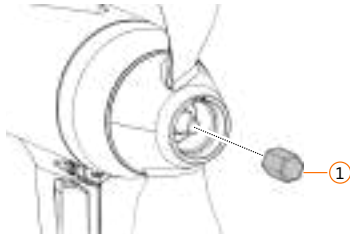

Installing the galvanic anode

- a) Install the galvanic anode (1).

NOTICE! Do not apply any thread locking varnish!

Shaft anode on motor shaft

- Shaft anode; AF 17; 7 Nm

9.3.8 Replacing the fin

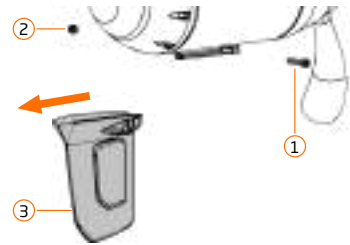

Disassembly

- a) Remove the screw (1).
- b) Remove the nut (2).
- c) Pull the fin (3) off the pylon.

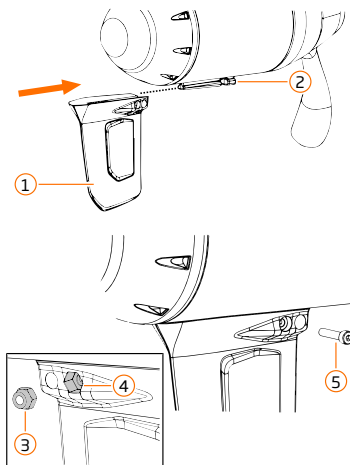

Installation

- a) Push the fin (1) onto the pylon (2).
- b) Insert the nut (3) into the pocket on the fin (4) provided for it.
- c) Insert the screw (5).

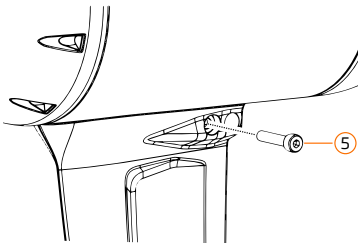

- d) Tighten the screw (5).
- Fin on pylon
Cylinder head screw M4x20 A4; Hex socket #3
Nut M4 A4; in fin pocket

9.3.9 Lubricating the remote steering

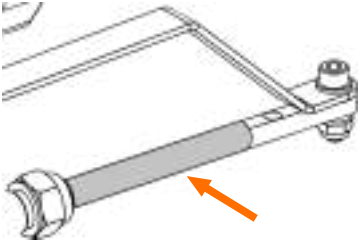

- a) Lubricate the surface of your remote steering (arrow), use a salt water-resistant lubricant if you intend to use the motor in sea water.

9.3.10 Lubricating the hybrid plug

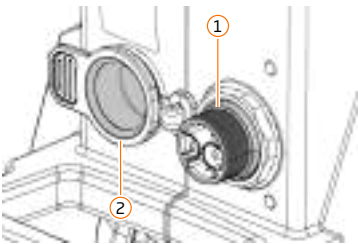

- a) **NOTICE! Component damage!** Only use silicone grease.
- b) **NOTICE! Operation impaired!** Only lubricate the specified points. Do not put silicone grease in the plug, as excess pressure can result when the battery is inserted, which will impair the contact connection.
- c) Only lubricate the motor hybrid plug, the silicone grease will be transferred to the battery hybrid plug when the battery is inserted.
- d) Clean the sealing surface of the hybrid plug (1) and the surface of the sealing cap (2).
- e) Apply the silicone grease to the surface (1) of the motor hybrid plug.

9.3.11 Plug connectors

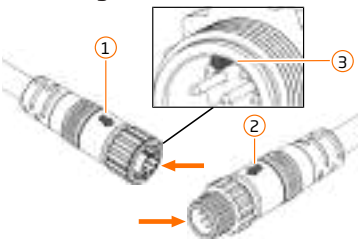

- a) Disconnect the plug connector of the data cable.
- b) Treat the contacts (arrows) with contact spray.
- c) Connect the data cable, ensure that the markings (1) and (2) are in line and the lug (3) slides into the counterpart.
- d) Screw the plug connector carefully in place.

10 Errors and troubleshooting



WARNING

Rotating components!

These can cause serious cuts.

- a) Remove the emergency stop magnetic chip and take the battery out of the motor before carrying out any work or inspections on the propeller.
- b) Make sure that the motor is secured to prevent re-activation when working on it.

EN

10.1 Error notifications and messages

Error	Cause	Possible remedy
E21	Faulty calibration of tiller	Carry out calibration
E22	Magnetic sensor defective	
E23	Value range wrong	
E30	Motor communication error	Check the plug connector of the data cable.
E32	Tiller communication error	Clean the contacts with contact spray.
E33	General communication error	If necessary, get in touch with Torqeedo Service. Restart the motor.
E41	Incorrect charge voltage	Disconnect charger and do not use again.
E42		Contact Torqeedo Service.
E43	Discharge the battery	Charging the battery
E45	Battery overcurrent	Restart the motor. The battery has switched off because the power consumption is too high. Check that the propeller is moving freely. Contact Torqeedo Service.
E46	Battery too hot/cold Maximum power reduced	Allow battery to cool down/warm up.
E48	Charging temperature error	Allow battery to cool down/warm up, charging continues when cell temperature is in operating range.
E70	Battery too hot/cold. Charging not possible	

Get in touch with Torqeedo Service if error codes are not executed.

10.2 Faults and errors

Error	Cause	Possible remedy
The motor cannot be switched on	Hybrid plug contacts are damp	Blow off the hybrid plug. During storage, ensure that the protective cap is fitted to the hybrid plug
Battery does not charge when driving	Connection sequence not observed	First insert the battery in the motor and connect the solar panel or charger
Battery cannot be inserted	Protective cap on hybrid plug not fitted	Remove the protective cap from the hybrid plug
The motor is difficult to steer	Steering resistance setting is too high	You can set the steering resistance individually, see "Setting the steering resistance" section
Display is not responding	Software error	Remove battery, re-insert and restart motor
Bluetooth connection not possible	Software error	Restart the motor
Battery is not charging	Battery is overheating	Let the battery cool down
Propeller will not turn or only turns with difficulty	Foreign bodies, e.g. fishing line	Remove fishing line
	Fitting error, axial pressure disc missing	Fit the propeller correctly

11 Accessories and replacement parts



You will find accessories and replacement parts for your Torqeedo product on our homepage.

12 Copyright

These instructions and the texts, drawings, pictures and other illustrations contained in them are protected by copyright. Reproductions of any kind and in any form - including excerpts - and the exploitation and/or publication of the contents are not permitted without the written agreement of the manufacturer.

Non-compliance will result in compensation claims. Further claims remain reserved.

Torqueedo reserves the right to change this document without prior notice. Torqueedo has made considerable efforts to ensure that these instructions are free from errors and omissions.

13 General guarantee conditions

Warranty and liability

The statutory warranty is 24 months and covers all components of the Torqeedo system.

The warranty period starts from the day of delivery of the Torqeedo system to the end customer.

Scope of guarantee

Torqeedo GmbH, Claude-Dornier-Str. 1, Campus Ost / Geb. 901, 82234 Wessling, guarantees the end customer of a Torqeedo system that the product is free from defects in material and workmanship during the period of cover specified below. Torqeedo shall exempt the end customer from the costs of remedying a defect in material or workmanship. This exemption obligation does not apply to any incidental costs caused by a warranty claim or any other financial disadvantages (e.g. costs for towing, telecommunication, food, accommodation, lost use, lost time, etc.).

The guarantee ends two years after the date of delivery of the product to the end customer. Products that are used – even temporarily – for commercial or official purposes are excluded from the two-year warranty. The statutory warranty applies in these cases. Warranty claims expire six months after discovery of a defect.

It is at Torqeedo's discretion to determine whether defective parts are repaired or replaced. Distributors and dealers who carry out repair work on Torqeedo motors have no authority to make legally binding declarations on behalf of Torqeedo. Wear parts and routine maintenance are excluded from the warranty.

Torqeedo is entitled to refuse warranty claims if

- the warranty has not been properly submitted (in particular, contacting us before sending in the defective goods, submitting a fully completed warranty form and proof of purchase, refer to the warranty process).
- there has been improper handling of the product.
- the safety, handling and care instructions in the manual have not been followed.
- prescribed maintenance intervals were not observed and documented.
- the purchased item has been converted, modified or equipped with parts or accessories in any way that is not part of the equipment expressly approved or recommended by Torqeedo.
- previous maintenance or repairs have not been carried out by companies authorised by Torqeedo or parts other than original spare parts have been used. This applies unless the end customer can prove that the facts justifying the rejection of the warranty claim did not cause the defect.

In addition to the claims arising from this warranty, the end customer has statutory warranty claims based on the purchase contract with the respective dealer, which are not restricted by this warranty.

Warranty process

Compliance with the warranty process described below is a prerequisite for the fulfilment of warranty claims.

For the smooth processing of warranty claims, we ask you to take the following instructions into account:

Please contact Torqeedo Service in the event of a complaint. They will give you an RMA number if necessary.

In order for Torqeedo Service to process your complaint, please have your service check folder, your proof of purchase and a completed warranty form to hand.

When transporting products to Torqeedo Service, please note that improper transport is not covered by the warranty or guarantee.

If you have any queries about the warranty process, please contact us using the details on the back page.

14 Disposal and the environment



Torqueedo motors are manufactured in accordance with the WEEE Directive 2012/19/EU. This directive regulates the disposal of electrical and electronic equipment for sustainable protection of the environment. In accordance with regional regulations, you can hand in the motor at a collection point. From there, it is sent for proper disposal.

Disposal of waste electrical and electronic equipment

For customers in EU countries

The product is subject to European Directive 2012/19/EU on Waste Electrical and Electronic Equipment (WEEE) and the corresponding national legislation. The WEEE Directive forms the basis for EU-wide treatment of waste electrical and electronic equipment. The product is marked with the symbol of a crossed-out waste bin, see above. Waste electrical and electronic equipment must not be disposed of with normal waste, otherwise harmful substances may be released into the environment that have adverse health effects on humans, animals and plants and accumulate in the food chain and in the environment. In addition, valuable raw materials are lost in this way. Please therefore dispose of your old equipment in an environmentally friendly way by separate collection or contact your Torqueedo Service or your boat builder in this connection.

For customers in other countries

The product is subject to European Directive 2012/19/EU on waste electrical and electronic equipment. We recommend that the system is not disposed of with the normal waste, but by separate collection in an environmentally friendly way. National legislation may also require you to do so. Please therefore ensure proper disposal of the system in accordance with the regulations in force in your country.

Disposal of batteries

Remove a spent battery immediately and follow the instructions below regarding special disposal of batteries and battery systems:

For customers in EU countries

Single use and rechargeable batteries are subject to European Directive 2006/66/EC on (waste) batteries and the corresponding national legislation. The Battery Directive forms the basis for EU-wide treatment of single use and rechargeable batteries. Our batteries are marked with the symbol of a crossed-out waste bin. Below this symbol is the name of any harmful substances they contain. Used batteries must not be disposed of with the normal waste, as harmful substances may be released into the environment that have adverse health effects on humans, animals and plants and accumulate in the food chain and in the environment. In addition, valuable raw materials are lost in this way. Please only dispose of your old batteries via specific collection points, your dealer or the manufacture.

For customers in other countries

Batteries are subject to European Directive 2006/66/EC on (waste) batteries. The batteries are marked with the symbol of a crossed-out waste bin. Below this symbol is the name of any harmful substances they contain. We recommend that the batteries are not disposed of with the normal waste, but by separate collection. National legislation may also require you to do so. Please therefore ensure proper disposal of the batteries in accordance with the regulations in force in your region.

Support and service

Torqueedo companies

Germany

Torqueedo GmbH
Einsteinstrasse 901
82234 Wessling, Germany
info@torqeedo.com
T +49 - (0)8153 - 92 15 - 100

North America

Torqueedo Inc.
171 Erick Street, Unit A-1
Crystal Lake, IL 60014, USA
usa@torqeedo.com
T +1 - 815 - 444 88 06

EN