

# MASTERVOLT

THE POWER TO BE INDEPENDENT

## Mass Charger

**MASS 24/50-2; 24/50 3ph; 24/75; 24/75 (120V);  
24/100; 24/100 3ph; 48/25; 48/50**

FULLY AUTOMATIC BATTERY CHARGER



### USER AND INSTALLATION MANUAL

- Ⓔ**N** For the latest version of this manual, visit our website:
- Ⓔ**L** Ga om deze handleiding in andere talen te downloaden naar onze website:
- Ⓔ**E** Um diese Anleitung in anderen Sprachen herunterzuladen, besuchen Sie bitte unsere Website:
- Ⓔ**R** Pour télécharger ce manuel dans d'autres langues, consultez notre site Web :
- Ⓔ**S** Para descargar este manual en otros idiomas, visite nuestro sitio web:
- Ⓔ**T** Per scaricare questo manuale in altre lingue, visitare la pagina del prodotto sul nostro sito Web:

[www.mastervolt.com](http://www.mastervolt.com)

In case of any discrepancy in the interpretation of different language versions, the English version shall prevail.

## TABLE OF CONTENTS

<b>1 GENERAL INFORMATION</b> .....	<b>3</b>	3.12 Materials .....	9
1.1 Use of this manual .....	3	3.13 Connection .....	10
1.2 Validity of this manual .....	3	3.14 Installation step-by-step .....	11
1.3 Liability .....	3	3.15 Commissioning after installation .....	12
1.4 Identification label .....	3	3.15.1 General .....	12
1.5 Correct disposal of this product .....	3	3.15.2 MasterBus .....	12
<b>2 SAFETY INSTRUCTIONS</b> .....	<b>4</b>	3.16 Decommissioning .....	12
2.1 General .....	4	3.17 Storage and transportation .....	12
2.2 Explosive gases .....	4	<b>4 DIP SWITCH SETTINGS</b> .....	<b>13</b>
2.3 Warnings regarding the use of batteries .....	4	4.1 DIP switch operation .....	13
2.4 Warning regarding life support applications .....	5	4.2 DIP switch functions .....	13
2.5 Warranty .....	5	<b>5 OPERATION</b> .....	<b>14</b>
<b>3 INSTALLATION</b> .....	<b>6</b>	5.1 Introduction .....	14
3.1 Location .....	6	5.2 Switching on/off .....	14
3.2 Connections .....	6	5.3 The 3-step+ charge process .....	14
3.3 Wiring 6		5.4 Reset the Mass Charger .....	14
3.3.1 AC wiring .....	6	5.5 Equalize mode .....	14
3.3.2 AC safety grounding .....	6	5.6 LED indicators .....	14
3.3.3 DC wiring .....	7	<b>6 MASTERBUS</b> .....	<b>15</b>
3.3.4 Connection of main batteries .....	7	6.1 About MasterBus .....	15
3.4 Battery capacity .....	7	6.2 How to set up a MasterBus network .....	15
3.5 Battery isolator .....	7	6.3 MasterBus Settings .....	15
3.6 Connection of second battery (3A output) .....	7	6.4 Event based commands .....	17
3.7 Temperature sensor .....	7	<b>7 TROUBLE SHOOTING</b> .....	<b>18</b>
3.8 Voltage sense .....	8	<b>8 TECHNICAL DATA</b> .....	<b>19</b>
3.9 Alarm function .....	8	8.1 Specifications .....	19
3.9.1 Standard alarm mode .....	8	8.2 Dimensions .....	21
3.9.2 DC alarm mode .....	8	8.3 Characteristics .....	22
3.10 RJ12 splitter for enclosure C2 .....	8		
3.11 Overview connection compartment .....	9		

# 1 GENERAL INFORMATION

## 1.1 Use of this manual

This manual contains important safety and operating instructions for the safe and effective operation, maintenance and possible correction of minor malfunctions of the Mass Charger. It is therefore obligatory that every person who works on or with this product is completely familiar with the contents of this manual, and that he/she carefully follows the instructions and important safety instructions contained herein.

## 1.2 Validity of this manual

All the specifications, provisions and instructions contained in this manual apply solely to standard versions of the Mass Charger.

This manual is valid for the following models, in combination with firmware version 7.7.0 or higher:

Product code	Model	Enclosure type
40020506	Mass 24/50-2 230V/50-60Hz DNV-GL	C2
42020506	Mass 24/50-2 230V/50-60Hz	C2
40030506	Mass 24/50 400V 3 phase	C3
40020756	Mass 24/75 230V/50-60Hz DNV-GL	C3
42020756	Mass 24/75 230V/50-60Hz	C3
40120756	Mass 24/75 120V/60-50Hz DNV-GL	C3
42120756	Mass 24/75 120V/60-50Hz	C3
40021006	Mass 24/100 230V/50-60Hz DNV-GL	C3
42021006	Mass 24/100 230V/50-60Hz	C3
40031006	Mass 24/100 400V 3 phase	C3
40040256	Mass 48/25 230V/50-60Hz	C2
40040506	Mass 48/50 230V/50-60Hz	C3

These models are further mentioned as “Mass Charger”.

Mastervolt offers a wide range of products for your electrical installation. For an extensive overview of all our products, please visit our website [www.mastervolt.com](http://www.mastervolt.com).

## 1.3 Liability

Mastervolt can accept no liability for:

- Consequential damage due to use of the Mass Charger.
- Use that is inconsistent with the purpose of the product.
- Possible errors in the manuals and their results.

**Disclaimer:** Our products are subject to continual development and improvement. Therefore, additions or modifications to the products may cause changes to the technical data and functional specifications. No rights can be derived from this document. Please consult our most current Terms & Conditions of Sale.

## 1.4 Identification label

The following picture is only an example!

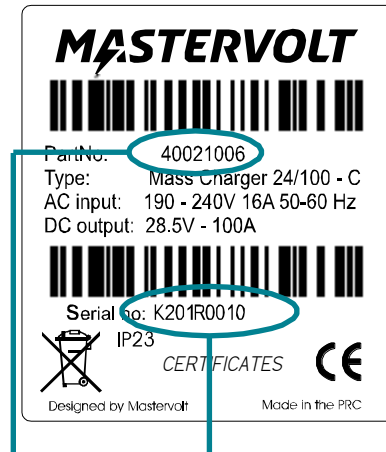

Part number    Serial number K201R0010 with device version “R”

Figure 1. Identification label

The identification label is located at the right-hand side of the Mass Charger. Important technical information required for service and maintenance can be derived from the identification label.



### CAUTION!

Never remove the identification label. This will void the warranty.

## 1.5 Correct disposal of this product



This product is designed and manufactured with high quality materials and components, which can be recycled and reused. Please be informed about the local separate collection system for electrical and electronic products. Please act according to your local rules and do not dispose of your old products with your normal household waste.

## 2 SAFETY INSTRUCTIONS

**Read the entire manual before using the Mass Charger.  
Keep this manual in a secure place.**



### **WARNING!**

This chapter describes important safety and operating instructions for use of a Mass Charger in residential, recreational vehicle (RV) and marine applications.

### **2.1 General**

- 1 To reduce the risk of electric shock – Do not expose Mass Charger to rain, snow, spray, moisture, excessive pollution and condensing circumstances. To reduce risk of fire hazard, do not cover or obstruct the ventilation openings. Do not install the Mass Charger in a non-ventilated room, overheating may result.
- 2 Use of an attachment or spare part not recommended or sold by Mastervolt may result in a risk of fire, electric shock, or injury to persons.
- 3 The Mass Charger is designed to be permanently connected to an AC and DC electrical system. Installation of, and work on the Mass Charger, may be carried out only by a qualified, authorised and trained technician or electrician, consistent with the locally applicable standards and regulations.
- 4 Make sure that all wiring is properly installed and in good electrical condition; and that wire size is large enough for AC current rating of the Mass Charger. Check the wiring on a regular base, at least once a year. Do not use the Mass Charger when the wiring is undersized or damaged.
- 5 Do not operate the Mass Charger if it has received a sharp blow, been dropped, or otherwise damaged in any way; take it to qualified personnel.
- 6 Except for the connection compartment (see section Overview connection compartment 3.11 on page 9), the Mass Charger may not be opened or disassembled. There are no serviceable parts inside the cabinet. Take it to qualified, authorized and trained service personnel when service or repair is required. Incorrect reassembly may result in a risk of electric shock or fire. Only qualified, electrician installers are authorized to open the connection compartment.
- 7 To reduce risk of electric shock, disconnect the Mass Charger from both AC and DC electrical system before attempting any maintenance or cleaning. Turning off controls will not reduce this risk.
- 8 The Mass Charger must be provided with an equipment-grounding conductor to the AC input ground terminal. Grounding and all other wiring must comply with local codes and ordinances.
- 9 Short circuiting or reversing polarity will lead to serious damage to batteries, Mass Charger, wiring as well as accessories. Fuses cannot prevent damage caused by reversed polarity and the warranty will be void.
- 10 In case of fire, you must use the fire extinguisher which is appropriate for electrical equipment.
- 11 If applied in a marine application in the United States, external connections to the Mass Charger shall comply with the United States Coast Guard Electrical Regulations (33CFR183, Sub part I).

### **2.2 Explosive gases**

- 1 **WARNING:** risk of explosive gases. Working in vicinity of a lead-acid battery is dangerous. Batteries generate explosive gases during normal battery operation. For this reason, it is of utmost importance that each time before using the Mass Charger, you read this manual and follow the instructions exactly.
- 2 To reduce risk of battery explosion, follow these instructions and those published by battery manufacturer and manufacturer of any equipment you intend to use in vicinity of the battery. Review cautionary marking on these products.
- 3 **DANGER:** To reduce the risk of explosion – Never use the Mass Charger in situations where there is danger of gas or dust explosion or an area in which ignition-protected equipment is required.

### **2.3 Warnings regarding the use of batteries**

- 1 Someone should be within range of your voice or close enough to come to your aid when you work near a lead-acid battery.
- 2 Have plenty of fresh water and soap nearby in case battery acid contacts skin, clothing, or eyes.
- 3 Wear complete eye protection and clothing protection. Avoid touching eyes while working near battery.
- 4 If battery acid contacts skin or clothing, wash immediately with soap and water. If acid enters eye, immediately flood eye with running cold water for at least 10 minutes and get medical attention immediately.
- 5 **NEVER** smoke or allow a spark or flame in vicinity of a battery or engine.
- 6 Do not short circuit batteries, as this may result in explosion and fire hazard! Be extra cautious to reduce risk of dropping a metal tool onto a battery. It might spark or short-circuit battery or other electrical part and may cause explosion.
- 7 Remove personal metal items such as rings, bracelets, necklaces, and watches when working with a battery.

A battery can produce a short-circuit current high enough to weld a ring or the like to metal, causing a severe burn.

- 8 Only use the Mass Charger for charging Lead-acid, NiCad and Li-ion batteries and the supply of users attached to these batteries, in permanent systems. Do not use the Mass Charger for charging dry-cell batteries that are commonly used with home appliances. These batteries may burst and cause injury to persons and damage to property.
- 9 NEVER charge a frozen battery.
- 10 Excessive battery discharge and/or high charging voltages can cause serious damage to batteries. Do not exceed the recommended limits of discharge level of your batteries.
- 11 If it is necessary to remove a battery, always remove the grounded terminal from the battery first. Make sure all accessories are off, so as not to cause an arc.
- 12 Be sure that the area around the battery is well ventilated while the battery is being charged. Refer to the recommendations of the battery manufacturer.
- 13 Batteries are heavy! It may become a projectile if it is involved in an accident! Ensure adequate and secure mounting and always use suitable handling equipment for transportation.
- 14 Study all battery manufacturer's specific precautions while charging and recommended rates of charge. Note that the Mass Charger charge specifications are based on Mastervolt batteries. Specifications for a given chemistry of a different manufacturer may vary. If connecting batteries of a different manufacturer,

make sure the manufacturer's recommendations are met.

#### **2.4 Warning regarding life support applications**

Mastervolt products are not designed to be used as component of medical equipment, unless negotiated in the form of a written agreement between customer and/or manufacturer and Mastervolt. Such agreement will require the equipment manufacturer either to contract additional reliability testing of the Mastervolt parts and/or to commit to undertake such testing as a part of the manufacturing process. In addition the manufacturer must agree to indemnify and not hold Mastervolt responsible for any claims arising from the use of the Mastervolt parts in the life support equipment.

#### **2.5 Warranty**

The Mastervolt product warranty covers the Mass Charger for the first two years after the purchase date, on the condition that the product is installed and used according to the instructions in this manual.

Installation or use that do not comply with these instructions may result in under performance, damage or failure of the product and may void this warranty. The warranty is limited to the cost of repair and/or replacement of the product. Costs of labor or shipping are not covered by this warranty.

### 3 INSTALLATION

During installation and commissioning of the Mass Charger, the important safety instructions are applicable at all times. See chapter 2 on page 4.

Please check the contents of the box before you start with the installation. The contents of the box need to be:

- the Mass battery charger;
- battery temperature sensor (incl. 6m cable);
- a MasterBus terminator;
- the user manual.

If one of these items is missing, please contact your Mastervolt dealer.

#### 3.1 Location

Choosing a location to install:

- Install the Mass Charger in a well-ventilated room protected against rain, snow, spray, vapour, bilge, moisture and dust.
- Ambient temperature: 0...60°C/32°F...140°F; (power derating above 40°C/104°F to decrease the internal heat sink temperature).
- Humidity: 0-95% non-condensing.
- Never use the Mass Charger at a location where there is danger of gas or dust explosions
- Mount the Mass Charger in such a way that obstruction of the airflow through the ventilation openings is prevented. No objects must be located within 10cm/4inch around the Mass Charger.
- Mount the Mass Charger vertically, with the connecting cables downwards.
- Do not install the Mass Charger in the same compartment as the batteries. Do not mount the Mass Charger straight above the batteries because of possible corrosive sulphur fumes.

#### 3.2 Connections

Before making the connection between the battery charger and the system, be sure that the AC and DC system are switched off. Remove the fuses to protect yourself against unexpected start up.

#### 3.3 Wiring



##### CAUTION!

The wire and fuse sizes stated in this manual are given as example only. Prescribed wire and fuse sizes may be different due to local applicable regulations and standards.

#### 3.3.1 AC wiring

Check if the voltage of your mains source or generator corresponds with the AC input voltage of the battery charger as mentioned on the type number plate. See section 1.4 on page 3.

It is important that the green/ yellow earth wire is  $\pm 1$  cm (0.4 inch) longer than the other wires. By accidentally pulling at the cable, the earth wire stays connected to the Mass Charger longer which offers additional safety.

For a safe installation the correct wire cross section must be applied. Do not use a cross section that is smaller than indicated. See the following table to select the appropriate cross section for the AC wiring (up to 6m/20ft length):

AC Current	Minimum cross section:	
6-12A	1.5mm <sup>2</sup>	14AWG
12-20A	2.5mm <sup>2</sup>	12AWG
20-32A	4.0mm <sup>2</sup>	10AWG

#### Connection of AC wiring and recommended colours

- 230V [120V] installations:

Wire colour	Meaning	Must be connected to:
Brown or black [black]	Phase	L1
Blue [white]	Neutral	N
Green/yellow [green]	Earth	PE/GND

- 400V installations (Mass 24/50 3ph & 24/100 3ph):

Wire colour	Meaning	Must be connected to:
Brown/black/grey	Phase	L1, L2, L3
Green/yellow	Earth	PE/GND

#### 3.3.2 AC safety grounding



##### WARNING!

The ground wire offers protection only if the cabinet of the Mass Charger is connected to the safety ground. Connect the ground terminal (PE/GND) to the hull or the chassis.



##### CAUTION!

For safe installation it is necessary to insert an RCD (Residual Current Device; earth leakage switch) in the AC input circuit of the Mass Charger.

### 3.3.3 DC wiring

Keep the cable connection between charger and batteries as short as possible. If available, use coloured battery cables. If this is not possible, mark the plus and the minus cables with coloured insulating tape (e.g. red for plus and blue/black for minus). Use the following diameters:

Mass Charger	Length <3 m	Length 3-6 m
Mass 24/50-2 MB	25mm <sup>2</sup>	35mm <sup>2</sup>
Mass 24/50 3ph MB	25mm <sup>2</sup>	35mm <sup>2</sup>
Mass 24/75 MB	25mm <sup>2</sup>	35mm <sup>2</sup>
Mass 24/75 (120V) MB	25mm <sup>2</sup>	35mm <sup>2</sup>
Mass 24/100 MB	35mm <sup>2</sup>	50mm <sup>2</sup>
Mass 24/100 3ph MB	35mm <sup>2</sup>	50mm <sup>2</sup>
Mass 48/25 MB	10mm <sup>2</sup>	16mm <sup>2</sup>
Mass 48/50 MB	25mm <sup>2</sup>	35mm <sup>2</sup>

### 3.3.4 Connection of main batteries

- 1 Pull the cables through the cable glands of the Mass Charger.
- 2 Crimp on ring terminals to the cable:
  - ring M6 for 24/50-2, 48/25;
  - ring M8 for 24/75, 24/75 (120V), 24/100, 48/50, 24/50 3ph and 24/100 3ph.
- 3 Connect the cables to the terminals of the Mass Charger. Pay attention to the polarity, positive on positive/negative on negative.
- 4 Integrate a suitable fuse (charger fuse) in the positive cable. When using a DC distribution with fuses, no additional fuse is necessary.
- 5 Cut the cables to length and crimp on the ring terminals. Connect the cable to the DC distribution or batteries.



#### CAUTION!

Reversing the positive and negative battery poles will severely damage the Mass Charger.

Lay the positive and negative cables next to each other to limit the electromagnetic field around the cables. The negative cable should be connected directly to the negative post of the battery bank or the ground side of a current shunt. Do not use the hull or chassis frame as the negative conductor.

### 3.4 Battery capacity

Always follow the instructions published by the battery manufacturer.

Mass Charger	Recommended battery capacity
Mass 24/50-2	100Ah – 500Ah
Mass 24/50 3ph	100Ah – 500Ah
Mass 24/75	150Ah – 750Ah
Mass 24/75 (120V)	150Ah – 750Ah
Mass 24/100	200Ah – 1000Ah
Mass 24/100 3ph	200Ah – 1000Ah
Mass 48/25	50Ah – 250Ah
Mass 48/50	100Ah – 500Ah

### 3.5 Battery isolator

If one or more batteries or battery sets must be charged at the same time via one output, a battery isolator should be used. This isolates the different battery sets to prevent one discharging the other. Mastervolt offers several Battery Isolators. Please refer to [www.mastervolt.com](http://www.mastervolt.com).

A battery isolator causes a voltage drop of 0.6V. This can be compensated in two ways:

- By changing DIP switch 4 to On (Diode enabled);
- By using the voltage sense function (see section 3.8 on page 8);



#### CAUTION!

Never use both methods. Your batteries will be overcharged and severely damaged!

If you use a 'voltage drop free' battery isolator, like the Mastervolt Battery Mate, no compensation is needed.

For a proper installation, see the connection diagram that comes with the battery isolator.

### 3.6 Connection of second battery (3A output)

The Mass 24/50-2 MB is standard equipped with a second charge output which can be used to give a maintenance charge to a small second battery set like a starter battery. The maximum charge current of the second output is 3A, which comes from the main output.

- Use 2.5 to 4mm<sup>2</sup> cable for the connection.
- Connect the minus of the second battery to the minus of the main battery.
- Connect the plus of the second battery to the +3A terminal of the Mass Charger (Figure 3 and Figure 4).
- Integrate a 10A slow blow fuse in the plus cable.

### 3.7 Temperature sensor

The standard temperature sensor is provided with 6m cable and a double-sided tape for easy installation.

1. Make sure that the side of the battery that you want to place the sensor, is clean and grease-free.
2. Remove the piece of paper from the tape and stick the sensor on the battery.
3. Plug the modular cable into the terminal at the right of the Mass Charger (see Figure 3 on page 9). For the C3 enclosure (refer to specifications) both "RS232" and "analog" are suitable.

It is not necessary to shorten the cable. When you want to shorten it anyway, please notice the polarity of the plug and use the old connector as an example.

Now when the battery temperature is low, the charge voltage increases and when the battery temperature is high, the charge voltage is decreased. This prevents overcharge, and gassing, which increases the battery's lifetime substantially.

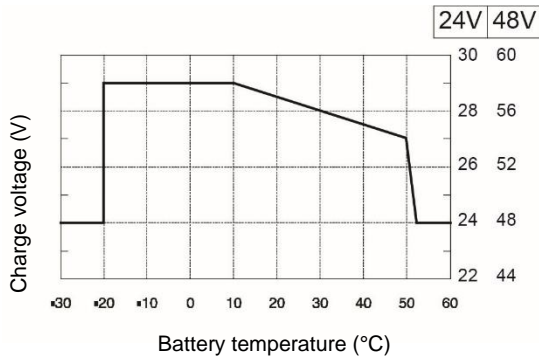

Figure 2. Temperature compensated charging

### 3.8 Voltage sense

If required, DC cable losses can be compensated by using the *sense* function. This will shorten the charge time.

1. Use 0,75mm<sup>2</sup>, preferably red and black wire and secure these with fuses of 2A slow blow.
2. Connect the wires with the two upper terminals of the green connector at the right side of the cabinet (see Figure 3 on page 9). Pay extra attention to the polarity of the wires, red on +S and black on -S.
3. Now connect the other side of the wires: black on the minus of the battery and red on the plus of the battery.

### 3.9 Alarm function

To control external equipment, the charger is equipped with a potential free contacts alarm relay; see Figure 3 on page 9. The alarm function has two modes: standard (factory setting) and DC alarm mode (continuous mode). The maximum switch current of the relay is 1A. Exceeding the setpoints will activate the alarm (see page 16).

#### 3.9.1 Standard alarm mode

In this mode the relay responds to all fault conditions that the Mass Charger can detect such as: no AC input voltage, low DC voltage, temperature sense failure.

#### 3.9.2 DC alarm mode

To enable this mode, a DIP switch setting needs to be changed (switch 1 and 2 at ON). The alarm now works as a DC alarm and responds to the battery voltage only.

**Note:** In the DC alarm mode the electronics stay active permanently and drain a very small current of  $\pm 25\text{mA}$ , also when the Mass Charger is switched off.

### 3.10 RJ12 splitter for enclosure C2

The RJ12 connector (QRS232 communication port) can be used to connect the battery temperature sensor or the remote panel (not included). Use a RJ12-splitter to connect both at the same time (not included).



### 3.11 Overview connection compartment

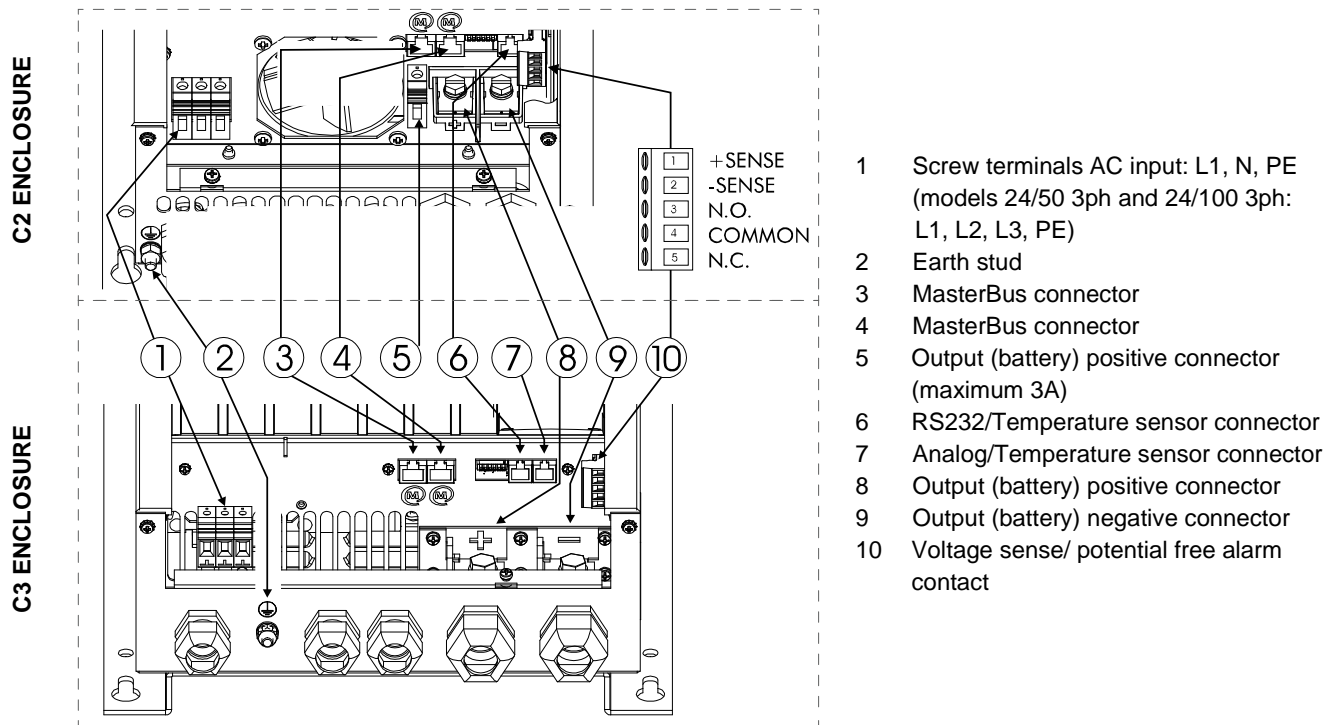

Figure 3. Overview connections Mass Charger

### 3.12 Materials

Make sure you have all the parts you need to install the Mass Charger:

Product	Quantity
Mass Charger (included)	1
Battery temperature sensor with cable and plug (included)	1
DC cable to connect the positive DC connection (+) of the Mass Charger to the positive pole of the DC distribution; for specifications see section 3.3.3 on page 6	1
DC cable to connect the negative DC connection (-) of the Mass Charger to the negative pole of the DC distribution; for specifications see section 3.3.3 on page 6	1
DC fuse holder with a DC fuse, to be integrated in the positive DC cable	1
Screws/bolts (Ø 6mm) (with plugs) to mount the cabinet to a surface. Use mounting materials which are suitable to carry the weight of the Mass Charger	4
AC cable* to connect the AC input to an external power source (e.g. a shore connection or a generator set)	1
Batteries. See section 3.4 on page 7 for recommended capacity	X
Appropriate and reliable cable terminals, cable lugs, battery terminals and cord end terminals	X

\* Double insulated three-wire cable with wire colours according to the locally applicable regulations. The applicable length and wire diameter depend on the electrical installation (see section 3.3.1 on page 6).

We recommend as a minimum tool kit:

- Socket wrench 13mm to fix the DC input (battery) cables
- Flat blade screwdriver 1.0 x 4.0mm to fix the screw terminals
- Tools to fix the screws/bolts (Ø 6mm) with plugs to mount the cabinets to a surface
- Philips screwdriver to open the connection area of the Mass Charger
- 2mm flat blade screwdriver for the sense terminal (see Figure 3, point 10).

### 3.13 Connection



#### WARNING!

Let installation work be done by a licensed electrician. Before beginning with the connection of the wiring, make the AC distribution as well as the DC distribution voltage free.

**Note:** If the battery temperature remains within 15-25°C, the battery temperature sensor is optional.



#### CAUTION!

Too-thin cables and/or loose connections can cause dangerous overheating of the cables and/or terminals. Therefore, tighten all connections well, in order to limit transition resistance as far as possible. Use cables of the correct size.

**Note:** The Mass Charger supports MasterBus and RS 232 compatible remote control panels.

The following schematic illustrates the general placement of the Mass Charger. It is not meant to provide detailed wiring instructions for any particular electrical installation.

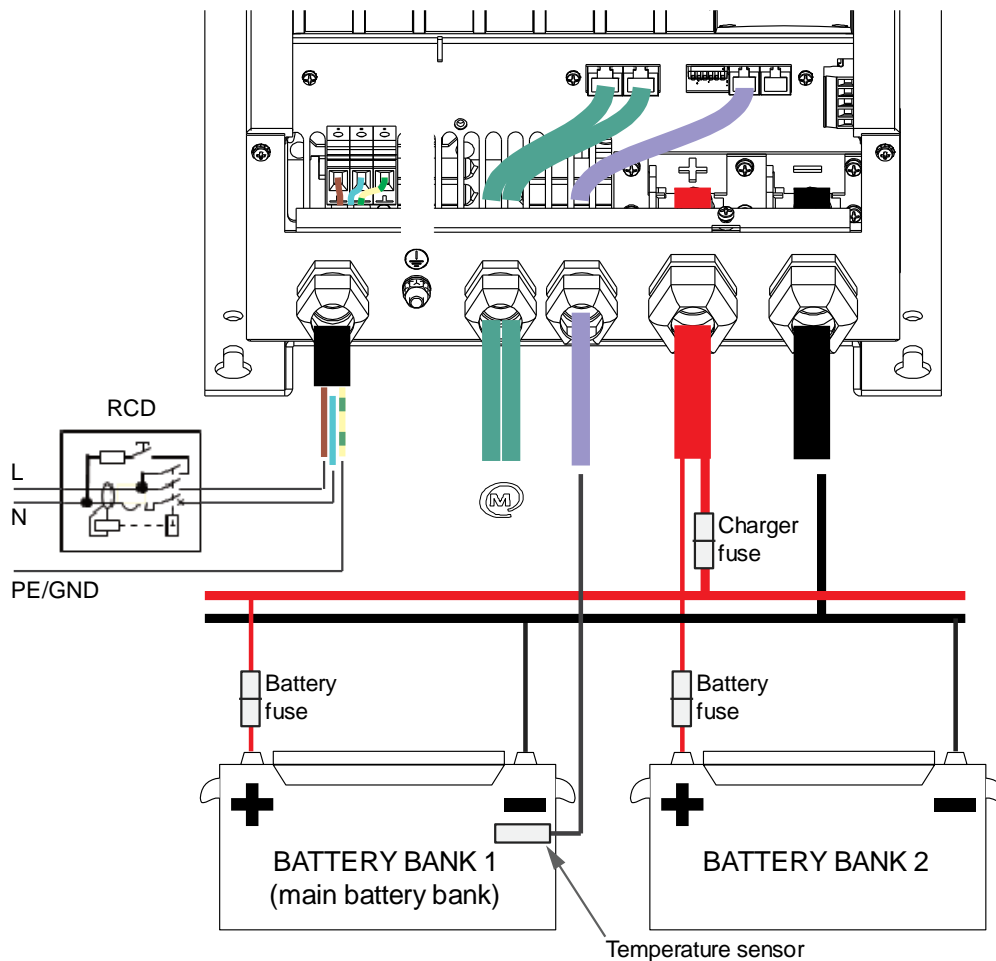
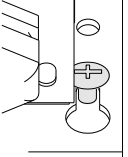

Figure 4. Installation drawing of the Mass Charger

### 3.14 Installation step-by-step

**1** Mark the position of the mounting spots using the drilling dimensions.

**2** Place the four screws first and hang the Mass Charger over them. Then fix the Mass to the wall by securing the screws.



**3** Open the connection compartment by loosening the two screws.

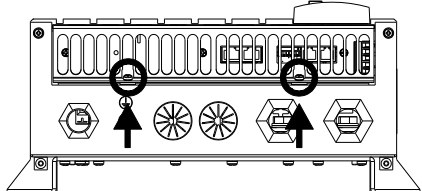

**4** Feed the AC wiring through the cable gland and connect the wiring to the screw terminals. Tighten the cable gland firmly.

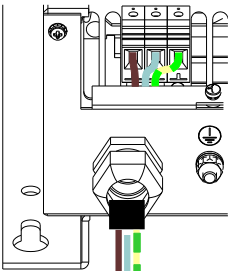

**5** Connect the DC cabling of the house bank, positive to +, negative to - .

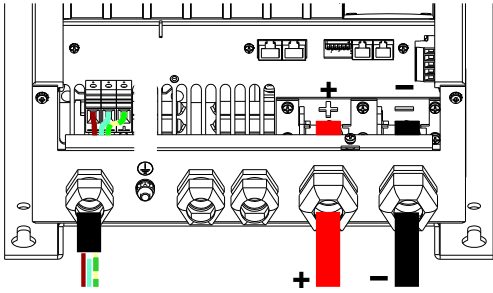

**6** Option for model 24/50:  
Connect the DC wiring of the second battery bank (max. 3A). This bank has a common negative with the main battery.

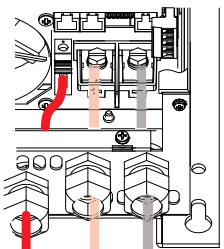

**7** Attach the battery temperature sensor to the casing of the main battery bank. Plug the temperature sensor cable into the "Temp.Sensor" jack. See also Figure 3 on page 9.

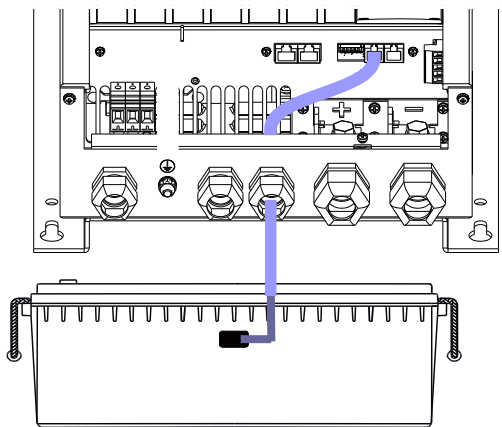

**7** Option: Connect the Mass Charger to the MasterBus network.

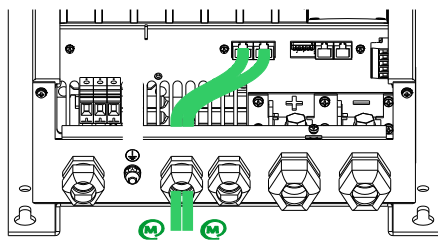

**8** The factory setting of the Mass Charger is optimal for most installations. Sometimes however, it is desirable to change these settings. See chapter 4 (page 13) and section 6.3 (page 15).

**9** Check all wiring. If everything is all right, close the connection compartment by fixing the two screws.

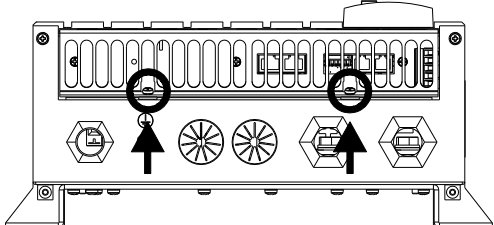

**10** Continue with section 3.15 for commissioning of the Mass Charger.

### 3.15 Commissioning after installation

**Note:** When your Mass Charger is not new, you have to consider that former users may have changed the settings. Reset the Mass Charger to factory settings when there is any doubt (see section 6.3 on page 15).

#### 3.15.1 General

The factory settings of the Mass Charger are optimal for most installations. With some applications however, it is desirable to change these settings. Therefore, several adjustments can be made. See chapters 4 and 6.3.

**Note:** The DIP switches must be adjusted prior to commissioning. All other settings can only be configured after commissioning.



#### **CAUTION!**

Check the polarity of all wiring before commissioning: positive connected to positive (red cables), negative connected to negative (black cables).

If all wiring is OK, place the DC fuse(s) of the DC distribution to connect the batteries to the Mass Charger.



#### **WARNING!**

When placing this fuse, a spark can occur, caused by the capacitors used in the Mass Charger.

Now the Mass Charger is ready for operation. After switching on the AC power supply the Mass Charger will initiate the charging process.

#### 3.15.2 MasterBus

Adjustment of the settings of the Mass Charger can be made by means of DIP switches or via the MasterBus network (by means of an USB interface connected to a PC with MasterAdjust software). Some settings can only be changed via the MasterBus interface. See section 6.3 on page 15 for an overview of all available MasterBus settings.

#### 3.16 Decommissioning

If it is necessary to put the Mass Charger out of operation, follow the instructions in order of succession as described below:

- 1 Switch the Mass Charger to **OFF**.
- 2 Remove the DC fuse(s) of the DC distribution and/or disconnect the batteries.
- 3 Remove the AC fuse(s) of the AC input and/or disconnect the AC mains.
- 4 Open the connection compartment of the Mass Charger.
- 5 Check with a suitable voltage meter whether the inputs and the outputs of the Mass Charger are voltage free.
- 6 Disconnect all wiring.

Now the Mass Charger can be demounted in a safe way.

#### 3.17 Storage and transportation

When not installed, store the Mass Charger in the original packing, in a dry and dust free environment.

Always use the original packing for transportation. Contact your local Mastervolt dealer for further details if you want to return the apparatus for repair.

## 4 DIP SWITCH SETTINGS

The Mass Charger settings can be adjusted in two ways:

- By means of DIP switches;
- Via the MasterBus network (using a remote control panel or the Mastervolt USB interface connected to a PC with MasterAdjust software); see chapter 6.

**Note:** Once a DIP switch has been set to On, MasterBus presets are disabled but people can still change the settings!



### CAUTION!

Invalid settings of the Mass Charger can cause serious damage to your batteries and/or the connected load! Adjustments of settings may be undertaken by qualified personnel only!

### 4.1 DIP switch operation

The Mass Charger has six DIP switches. These switches are operated by flipping the levers to the other position, using a small screwdriver.

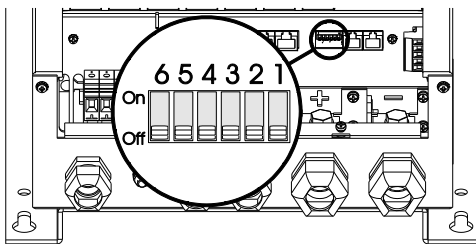

Figure 5. DIP switches

### 4.2 DIP switch functions

See the table for the functional overview of the DIP switches (DIP switch 6 is reserved for future use). See page 16 for an overview of charging specifications.

- **Force Float (DIP switch 1)**  
For special applications a fixed charge voltage can be required. The battery charger allows you to change the 3-step+ charge program to a single stage program by activating the function "Force Float", switching DIP switch 1 to "ON".  
The charge voltage will be fixed at 26.5V (24V charger) or 53V for a 48V charger.
- **Traction setting (DIP switch 2)**  
Setting for traction charging: +0.7/1.4V during bulk and +0.4/0.8V in absorption for 24/48V batteries.
- **Gel/AGM batteries (DIP switch 3)**  
Some Gel/AGM batteries need a higher float voltage for optimal charge. Changing the float voltage can be done by setting DIP switch 3 to "ON". The float voltage will increase to 27.6V (24V charger) or 55.2V for a 48V charger.

- **Diode setting (DIP switch 4)**  
Setting for +0.6V voltage compensation in case a battery isolator is used.
- **Lithium-ion setting (DIP switch 5)**  
With firmware version 7.7.0 or higher, the settings for charging an MLI Ultra can be selected.

	DIP SWITCH	5	4	3	2	1
Controlled by MasterAdjust		0	0	0	0	0
ForceFloat		0	0	0	0	1
ContMon		0	0	0	1	1
Diode		0	1	0	0	0
ForceFloat + Diode		0	1	0	0	1
ContMon + Diode		0	1	0	1	1
Flooded		1	0	1	0	0
ForceFloat + Flooded		1	0	1	0	1
ContMon + Flooded		1	0	1	1	0
Diode + Flooded		1	1	1	0	0
ForceFloat + Diode + Flooded		1	1	1	0	1
ContMon + Diode + Flooded		1	1	1	1	0
Gel/AGM		0	0	1	0	0
ForceFloat + Gel/AGM		0	0	1	0	1
ContMon + Gel/AGM		0	0	1	1	1
Diode + Gel/AGM		0	1	1	0	0
ForceFloat + Diode + Gel/AGM		0	1	1	0	1
ContMon + Diode + Gel/AGM		0	1	1	1	1
Traction		0	0	0	1	0
ContMon + Traction		0	0	1	1	0
Diode + Traction		0	1	0	1	0
ContMon + Diode + Traction		0	1	1	1	0
Lithium-ion		1	0	0	0	0
ForceFloat + Lithium-ion		1	0	0	0	1
ContMon + Lithium-ion		1	0	0	1	1
Diode + Lithium-ion		1	1	0	0	0

1 = On; 0 = Off

**ForceFloat:** One step charge program with fixed float voltage.

**ContMon:** Continuous monitor mode. MasterBus, RS232 and DC alarm stay functioning at mains failure. Remote stays functioning if it has its own power source.

**Diode:** Diode compensation on (+0.6V)

## 5 OPERATION

### 5.1 Introduction

The Mass charger is a fully automatic, high efficiency battery charger/rectifier. The Mass Charger not only charges batteries rapidly and safely, it supplies the connected consumers at the same time. In addition, the Mass Charger is secured against short circuit, overload and high temperatures in an industrial environment.

### 5.2 Switching on/off

Activate the Mass Charger by switching the main switch to the **ON** position. When no error is present, the charger LED illuminates green and the Mass Charger starts charging.

Move the switch to the **OFF** position to switch off the Mass Charger!

### 5.3 The 3-step+ charge process

The Mass charger is equipped with an intelligent 3-step+ charge characteristic which takes care of an optimal charge of your batteries. See Figure 6 and Figure 9 (page 22) for more details.

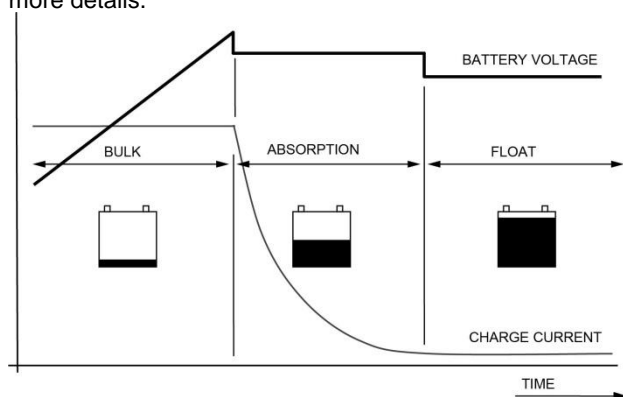

Figure 6. the 3-step+ charge process.

### 5.4 Reset the Mass Charger

1. Set the main switch to **off**.
2. Switch **on** again.

The Mass Charger automatically resumes operation in Bulk stage after it was disconnected from an AC source.

### 5.5 Equalize mode

An equalizing charge can be necessary after very deep discharges and/or inadequate charges. This has to be carried out according to the specifications of the battery manufacturer.



#### WARNING!

Equalization is **ONLY** applicable for flooded batteries and will damage Gel/AGM/Spiral type batteries!

Incorrect use of the equalize mode may lead to hazardous situations. During equalizing the batteries are brought into the gas state and permitted load voltages may be exceeded (refer to Figure 10 on page 23 for characteristics). For these reasons the equalizing mode should only be used by trained technical engineers.

The equalizing mode can only be started when the Mass Charger is in float operation. To start the equalize mode, select Equalize in the MasterBus device settings (see section 6.3 on page 15).

### 5.6 LED indicators

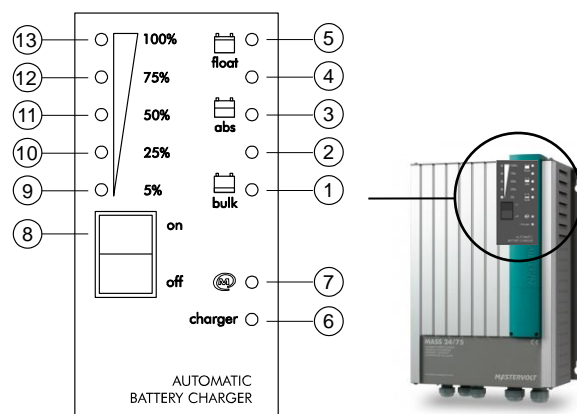

Figure 7. Front panel of the battery charger

During normal operation the charger LED (6) is green.

When all charge process status LEDs (1 to 5) are on, the battery is fully charged. For details refer to Figure 9 on page 22.

#### 1...5 Status LEDs charge process

##### 6 Charger status LED:

- Green = on
- Off = off
- Red = fault condition:

⑥+①: Battery sense error

⑥+②: Charger temperature too high

⑥+③: Short circuit indication, charger will reduce the charge current to 25%

⑥+④: DC error, DC voltage too low or too high

⑥+⑤: Temperature sense error

##### 7 Status LED MasterBus communication:

- Green = MasterBus communication
- Off = no MasterBus communication

##### 8 Main or on/off switch

#### 9...13 Status LEDs charge current

## 6 MASTERBUS

### 6.1 About MasterBus



All devices that are suitable for MasterBus are marked with the MasterBus symbol.

MasterBus is a CAN based, fully decentralized data network for communication between Mastervolt devices. MasterBus is used as power management system for all connected equipment, such as the inverter, battery charger, generator and many more.

Every device that is compatible with MasterBus is equipped with two data ports. The devices are simply chained together, forming a local data network. Monitoring panels such as the EasyView 5 can be used for monitoring and control of all connected MasterBus equipment.



#### CAUTION!

Never connect a non-MasterBus device to the MasterBus network directly! This will damage all connected MasterBus devices.

### 6.2 How to set up a MasterBus network

- Connections between the devices are made by standard straight MasterBus cables. Mastervolt can supply these cables.
- Up to 63 MasterBus devices can be connected together.
- MasterBus needs a terminator on both ends of the network.
- The electric power for the network comes from the connected devices according to the rule: 1 powering/3 non powering.
- Do not make ring networks.
- Do not make T-connections in the network.

### 6.3 MasterBus Settings

	Meaning	Factory setting	Adjustable range
<b>Device</b>			
Language	Language that is displayed on a monitoring device connected to the MasterBus.	English	EN, NL, DE, FR, ES, IT, NO, SV, FI, DA
Name	Name for the Mass Charger.	CHG Mass+type*	0-12 characters
Device	Device name recognized by MasterBus.	Mass Charger	-
Battery name	Name for the main battery bank.	House Bank	0-16 characters
Factory settings	Option to reset the Mass Charger to default settings.		
<b>Presets</b>			
Diode compensate	Option for charger diode +0.6V voltage compensation. If it is enabled, the compensation value is adjustable.	Disabled	Disabled, Enabled: 0-2.50V
Forced float	Option for Forced Float or constant voltage charging. If it is enabled, Forced Float voltage is adjustable.	Disabled	Disabled, Enabled
Continuous mode	Option to keep MasterBus powered by the battery when the Mass Charger is disabled.	Disabled	Disabled, Enabled
Battery	The battery type settings are based on Mastervolt batteries. If connecting batteries of a different manufacturer, make sure the manufacturer's recommendations are met. Should this not be the case, then "User defined" must be selected to change the settings.	Flooded	User defined, Gel/AGM, Flooded, Traction, NiCad, Lithium-ion
Equalize	Option to enable Equalizing. Shows only when no other battery type has been selected.		
	 <b>WARNING!</b> Equalization is ONLY applicable for flooded batteries and will damage Gel/AGM/Spiral type batteries!		
<b>General</b>			
Max. current	Maximum charge current, adjustable model dependent.	(Max current)*	0 – I <sub>max</sub> *
Temp. compensate	Charge voltage compensation for temperature (V/°C).	-0.060/-0.120V/°C	-1.000 – 1.000V/°C

	Meaning	Factory setting	Adjustable range
Output reduction	Output reduction that can be used as target event to adjust the maximum current.	0%	0-90%
<b>Relay</b>			
<b>Alarm set points</b>			
DC Alrm high on	Alarm DC High on	32.00V*	16.00-32.00V*
DC Alrm high off	Alarm DC High off	30.00V*	16.00-32.00V*
DC Alrm low on	Alarm DC low on	20.00V*	16.00-32.00V*
DC Alrm low off	Alarm DC low off	22.00V*	16.00-32.00V*
DC Alrm delay	Alarm delay time	30 sec	0-255 sec
<b>Bulk</b>			
Bulk voltage	Bulk voltage	28.50V*	16.00-32.00V*
Max. bulk time	Maximum bulk timer	480 min	0-600 min
Min bulk time	Minimum bulk timer	2 min	0-600 min
Start bulk time	Voltage at which to start the bulk timer.	26.50V*	16.00-32.00V*
Bulk ret. volt.	Return to Bulk voltage	25.60V*	16.00-32.00V*
Bulk return time	Adjustable Return to Bulk time after the Return to Bulk voltage has been reached.	30 sec	0-255 sec
<b>Absorption</b>			
Abs. voltage	Absorption voltage	28.50V*	16.00-32.00V*
Max absorption	Maximum absorption timer	240 min	0-600 min
Min absorp. time	Minimum absorption timer	15 min	0-180 min
Return amps	Return to Float current (in A)	6.0 %*I <sub>max</sub>	0-25A
<b>Float</b>			
Float voltage	Float voltage	26.50V*	16.00-32.00V*
Equalize voltage	Equalize voltage	31.00V*	16.00-32.00V*
Equalize time	Equalize time	360 min	0-600 min

\* For a 48 V battery charger, multiply the voltages by two

**Note:** the following charge specifications are based on Mastervolt batteries. Specifications for a given chemistry of a different manufacturer may vary. For a 48V charger, multiply the voltages by four.

Charging specifications	Battery type				
	Flooded	GEL/AGM	Lithium-ion	Traction	NiCad
Bulk voltage	28.50V / 57.00V	28.50V / 57.00V	28.50V / 57.00V	29.10V / 58.20V	29.00V / 58.00V
Max bulk time	480 min	480 min	480 min	480 min	480 min
Min bulk time	2 min	2 min	2 min	2 min	2 min
Start bulk time at	26.50V / 53.00V	26.50V / 53.00V	26.50V / 53.00V	26.50V / 53.00V	26.50V / 53.00V
Return to bulk voltage	25.60V / 51.20V	25.60V / 51.20V	26.50V / 53.00V	25.60V / 51.20V	27.00V / 54.00V
Bulk return time	30 sec	30 sec	240 sec	30 sec	30 sec
Absorption voltage	28.50V / 57.00V	28.50V / 57.00V	28.50V / 57.00V	29.10V / 58.20V	29.00V / 58.00V
Max abs. time	240 min	240 min	240 min	240 min	240 min
Min abs. time	15 min	15 min	15 min	15 min	240 min
Return amps	6.0%* I <sub>max</sub>	6.0%* I <sub>max</sub>	6.0%* I <sub>max</sub>	6.0%* I <sub>max</sub>	6.0%* I <sub>max</sub>
Float voltage	26.50V / 53.00V	27.60V	27.00V / 54.00V	26.50V / 53.00V	29.00V / 58.00V

\* Depending on model



## 6.4 Event based commands

With MasterBus a device can be programmed to initiate an action at another connected device. This is done by means of event-based commands.

### Events

Field	Meaning	Factory setting	Adjustable range
Event x source	Event-based command. Mass Charger event that should result in an action by another device on the <i>MasterBus</i> network.	Disabled	See <i>Event source</i> list.
Event x target	Select a connected MasterBus device that should take action due to a Mass Charger event.	Select...	Selectable targets are system dependent.
Event x command	Action to be taken by the target device.	Select...	See command list in selected device manual
Event x data	Data is linked to the command. <i>On</i> changes the status to On at the first signal. <i>Off</i> changes the status to Off at the first signal. <i>Copy</i> lets the status follow the input. <i>Copy Invert</i> lets the status follow the opposite of the input <i>Toggle</i> changes the status at the 1 <sup>st</sup> signal and back at the 2 <sup>nd</sup> signal. It is used in combination with a pulse switch.	Off	Off, On, Copy, Copy Invert, Toggle.
Event x+1	The next event appears after enabling Event x.	Disabled	See Event x.

### Mass Charger event source list (Mass Charger as event source)

Event source	Meaning
Charging	Mass Charger state is On
Bulk	Charge stage is Bulk
Absorption	Charge stage is Absorption
Float	Charge stage is Float
Failure	Charger failure MasterBus alarm
CSI	Charger Status Interface MasterBus alarm to generate an audible alarm at charger failure
Equalize	Mass Charger is in Equalize mode
TC Error	Battery temperature sensor error
Fan	MasterBus signal for an external fan to start (at 50% load/50°C)
LED Bulk	LED Bulk illuminates
LED 20-40	LED 2 illuminates (see Figure 7)
LED Abs	LED Abs illuminates
LED 60-80	LED 4 illuminates (see Figure 7)
LED Float	LED Float illuminates
LED Failure	LED Failure illuminates

### Mass Charger event target list (Mass Charger as event target)

Event target	Meaning
Bulk	Command to start the Bulk stage of charge
Absorption	Command to start the Absorption stage of charge
Float	Command to start the Float stage of charge
On/ Standby	Command to switch on the Mass Charger
Output reduction	Command to reduce the output of the Mass Charger e.g. when set to 90%, max. current will be 10% when event is received

## 7 TROUBLE SHOOTING

In case of a failure, the Mass Charger display shows an error 'code' to help you find its source. See section 5.6 LED indicators, on page 14. If you cannot solve a problem using the following fault-finding table, contact your Mastervolt dealer. Make sure you have the part and serial number at hand (See section 1.4, on page 3).

Malfunction	Possible cause	What to do
No output voltage and/or current	No AC input.	Check AC wiring, check remote control panel.
	AC input voltage too low (< 180VAC).	Check input voltage, check generator.
	AC input frequency out of range.	Check input voltage, check generator.
Output voltage too low, charger supplies maximum current	Load that is connected to the batteries is larger than charger can supply.	Reduce load taken from the batteries.
	Batteries not 100% charged.	Measure battery voltage. After some time, this will be higher.
Charge current too low	Batteries almost fully charged.	Nothing, this is normal when the battery is almost fully charged.
	High ambient temperature.	Nothing; if ambient temperature is more than 40°C the charge current is automatically reduced.
	Low AC input voltage. At lower AC input voltages, the charge current is reduced. See Figure 8 on page 22.	Check AC input voltage.
Batteries not fully charged	Charge current too low.	See "Charge current too low".
	Current to load is too high.	Reduce load taken from the batteries.
	Charge time too short.	Use a battery charger with higher capacity.
	Battery temperature too low.	Use the battery temperature sensor.
	Defective or old battery.	Check battery and replace if necessary.
Batteries are discharged too fast	Battery capacity reduced due to wastage or sulphation, stagnation.	Charge and recharge a few times, this might help. Check battery and replace if necessary.
Batteries are too warm, gassing	Defective battery (short circuit in cell).	Check battery and replace if necessary.
	Battery temperature too high.	Use the battery temperature sensor.
	Charge voltage too high.	Check settings (see section 6.3 on page 15).

## 8 TECHNICAL DATA

### 8.1 Specifications

Model	Mass 24/50-2 DNV-GL	Mass 24/50-2	Mass 24/75 DNV-GL	Mass 24/75	Mass 24/75 (120V) DNV-GL	Mass 24/75 (120V)
Product code	40020506	42020506	40020756	42020756	40120756	42120756
<b>INPUT</b>						
Mains voltage	230V, -10% + 15%		230V, -10% + 15%		120V, -10% + 15%	
Frequency	50-60Hz ± 5Hz		50-60Hz ± 5Hz		60-50Hz ± 5Hz	
Inrush current	None, the battery charger is equipped with a soft start in accordance with IEC 1003-3					
Input current	7A		12A		25A	
Power factor (Cos phi)	1		1		1	
Maximum efficiency	89%		89%		89%	
Input power	1600W		2700W		2700W	
<b>OUTPUT</b>						
Nominal voltage	24Vdc		24Vdc		24Vdc	
Max charge current (I <sub>max</sub> )*	50A		75A		75A	
Outputs	1 x 50A + 1 x 3A		1 x 75A		1 x 75A	
Charge characteristic*	3-step+, fully automatic					
Battery types:	Flooded lead acid, Gel/AGM lead acid, NiCad, Lithium-ion (Mastervolt MLI) (see section 6.3 for settings)					
Default charge voltages at 25°C:						
Absorption voltage*	28.5V		28.5V		28.5V	
Float voltage*	26.5V		26.5V		26.5V	
Voltage ripple	max. 100mV RMS with resistive load @ full power					
Short circuit current (1/4 of I <sub>max</sub> )	12.5A		18.75A		18.75A	
Wire gauge (up to 3m length)	25mm <sup>2</sup>		25mm <sup>2</sup>		25mm <sup>2</sup>	
Charger fuse (external)	63A		80A		80A	
<b>ENVIRONMENTAL</b>						
Ambient temperature	-20 to 40°C** @ 100% output power, derated with 2.5%/°C above 40°C					
Cooling	Forced air, by means of a ventilator with variable speed					
Humidity	Maximum 95%RV, non-condensing					
<b>MASTERBUS</b>						
MasterBus powering capability	Yes		Yes		Yes	
MasterBus menu languages	English, Dutch, German, French, Spanish, Italian					
<b>ENCLOSURE TYPE</b>						
	<b>C2</b>		<b>C3</b>		<b>C3</b>	
Dimensions (hxwd)mm	See section 8.2 on page 21					
Protection degree	IP23		IP23		IP23	
Weight	5kg		9kg		9kg	
<b>COMPLIANCE</b>						
Standards, approvals & listings	CE, ABYC A-31, DNV GL, RRR, RMRS	CE, ABYC A-31, RRR, RMRS	CE, ABYC A-31, DNV GL, RRR, RMRS	CE, ABYC A-31, RRR, RMRS	CE, ABYC A-31, DNV GL, RRR, RMRS	CE, ABYC A-31, RRR, RMRS

\* Adjustable, see chapter 4.

\*\* The Mass 24/50-2 allows operation in ambient temperatures as high as 45°C.

Specifications are subject to change without prior notice.

Model	Mass 24/100 DNV-GL	Mass 24/100	Mass 24/50 3ph	Mass 24/100 3ph	Mass 48/25	Mass 48/50
Product code	40021006	42021006	40030506	40031006	40040256	40040506
<b>INPUT</b>						
Mains voltage	230V, -10% + 15%		3 x 365...550V	3 x 365...550V**	230V, -10% + 15%	230V, -10% + 15%
Frequency	50-60Hz ± 5Hz		50-60Hz ± 5Hz	50-60Hz ± 5Hz	50-60Hz ± 5Hz	50-60Hz ± 5Hz
Inrush current	None, the battery charger is equipped with a soft start in accordance with IEC 1003-3					
Current	16A		3.3A	6.5A	8A	16A
Power factor (Cos phi)	1		0.8	0.8	1	1
Efficiency	89%		89%	89%	89%	89%
Input power	3600W		1750W	3500W	1800W	3600W
<b>OUTPUT</b>						
Nominal voltage	24Vdc		24Vdc	24Vdc	48Vdc	48Vdc
Max charge current (I <sub>max</sub> )*	100A		50A	100A	25A	50A
Outputs	1 x 100A		1 x 50A	1 x 100A	1 x 25A	1 x 50A
Charge characteristic*	3-step+, fully automatic					
Battery types:	Flooded lead acid, Gel/AGM lead acid, NiCad, Lithium-ion (Mastervolt MLI) (see section 6.3 for settings)					
Default charge voltages at 25°C:						
Absorption voltage*	28.5V		28.5V	28.5V	57V	57V
Float voltage*	26.5V		26.5V	26.5V	53V	53V
Voltage ripple	max. 100mV RMS with resistive load @ full power					
Short circuit current (1/4 of I <sub>max</sub> )	25A		12.5A	25A	6A	12.5A
Cable size (within 3 m)	35mm <sup>2</sup>		25mm <sup>2</sup>	35mm <sup>2</sup>	10mm <sup>2</sup>	25mm <sup>2</sup>
Charger fuse (external)	125A		63A	125A	32A	63A
<b>ENVIRONMENTAL</b>						
Ambient temperature	-20 to 40°C @ 100% output power, derated with 2,5%/°C above 40°C					
Cooling	Forced air, by means of a ventilator with variable speed					
Humidity	Maximum 95%RV, non-condensing					
<b>MASTERBUS</b>						
MasterBus powering capability	Yes		Yes	Yes	Yes	Yes
MasterBus menu languages	English, Dutch, German, French, Spanish, Italian					
<b>ENCLOSURE TYPE</b>						
	<b>C3</b>		<b>C3</b>	<b>C3</b>	<b>C2</b>	<b>C3</b>
Dimensions (hxxd)mm	See section 8.2 on page 21					
Protection degree	IP23		IP23	IP23	IP23	IP23
Weight	9kg		10kg	10kg	5kg	9kg
<b>COMPLIANCE</b>						
Standards, approvals & listings	CE, ABYC A-31, DNV GL, RRR, RMRS	CE, ABYC A-31, RRR, RMRS	CE, ABYC A-31, RRR, RMRS	CE, ABYC A-31, RRR, RMRS	CE, ABYC A-31, RRR, RMRS	CE, ABYC A-31, RRR, RMRS

\* Adjustable, see chapter 4.

\*\* For device versions up to J (see section 1.4 on page 3): 3x 365...440V

Specifications are subject to change without prior notice.

## 8.2 Dimensions

**C2 enclosure (Mass 24/50 and 48/25)**

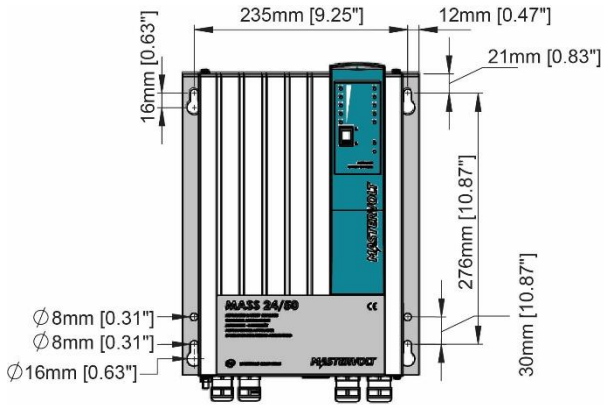

**C3 enclosure (other models)**

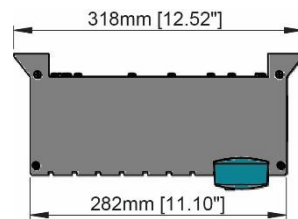
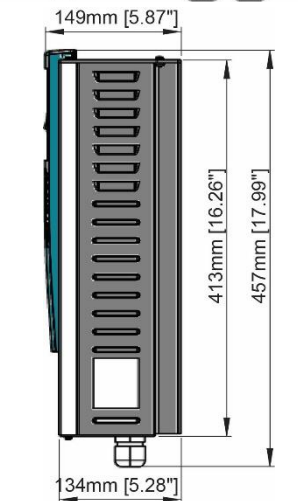
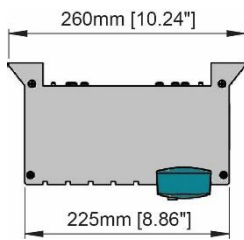
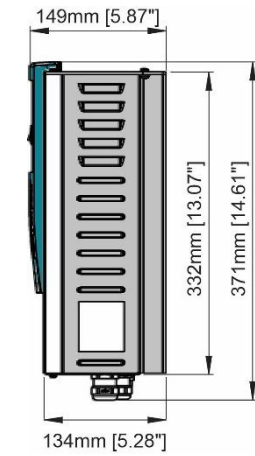
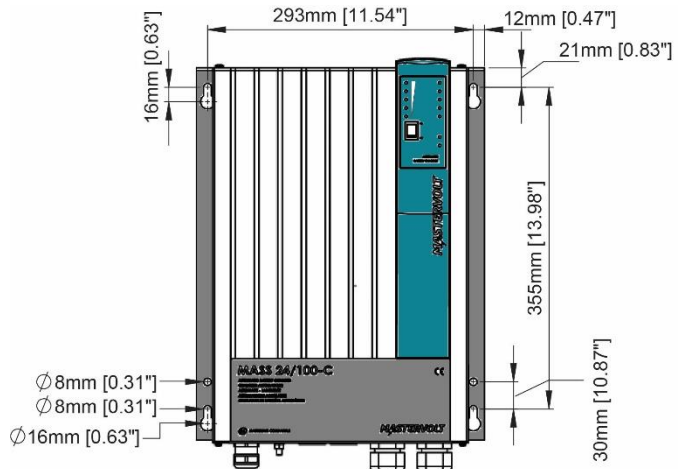

### 8.3 Characteristics

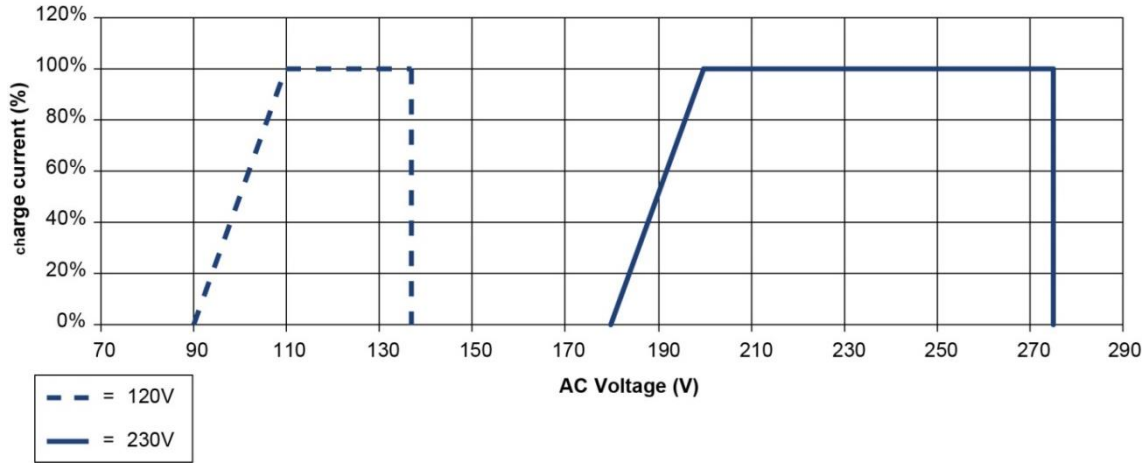

Figure 8. Charge current versus input voltage

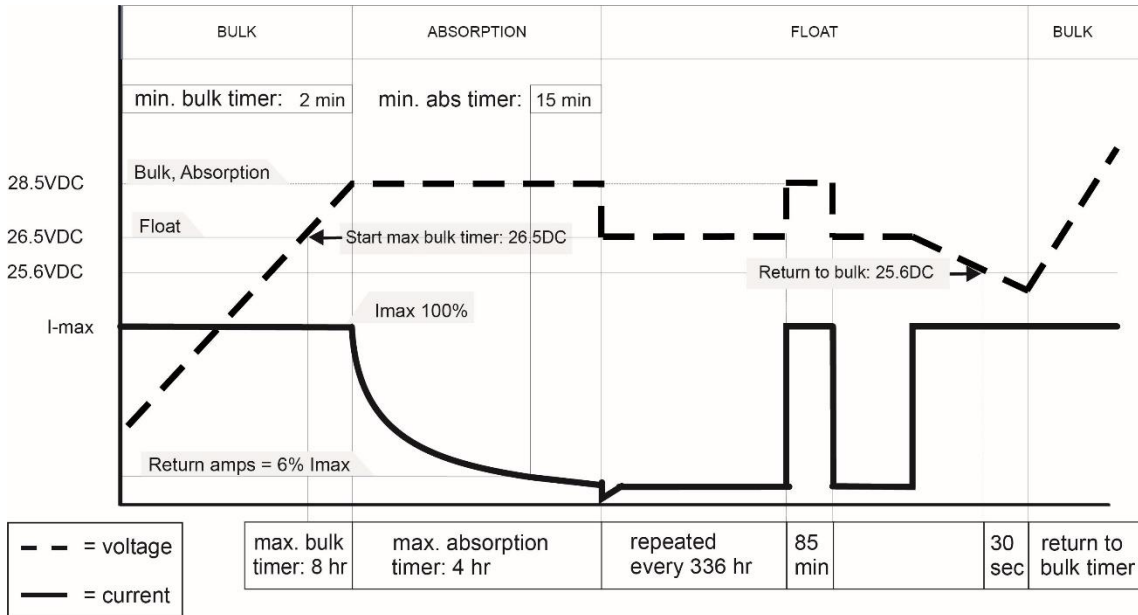

Figure 9. Charge characteristic of the 3-step+ charging method (at 25°C/77°F)

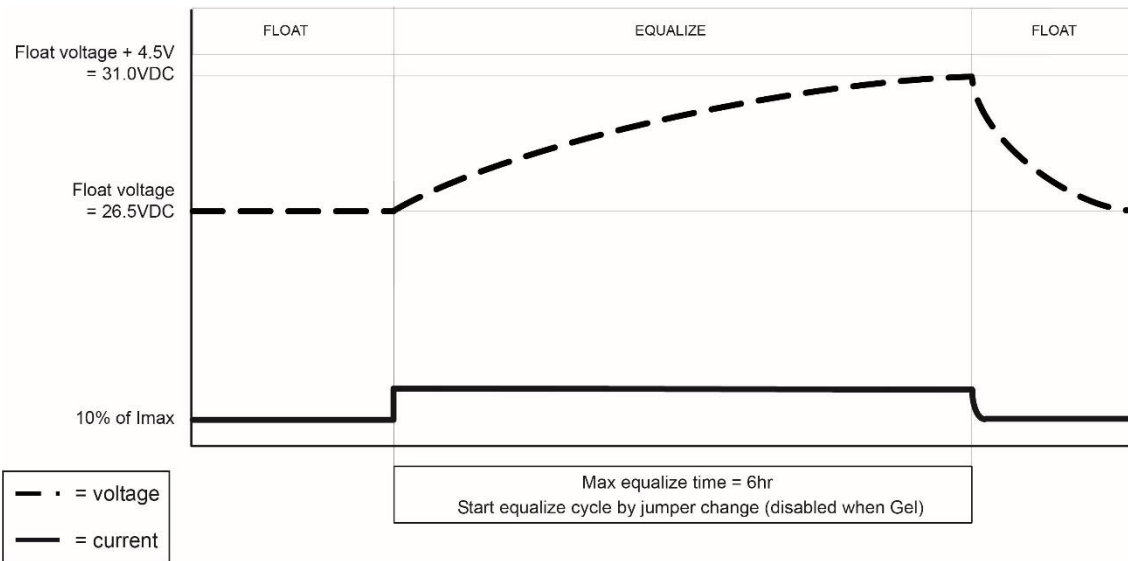

Figure 10. Charge characteristic of the equalize charge cycle (at 25°C/77°F)

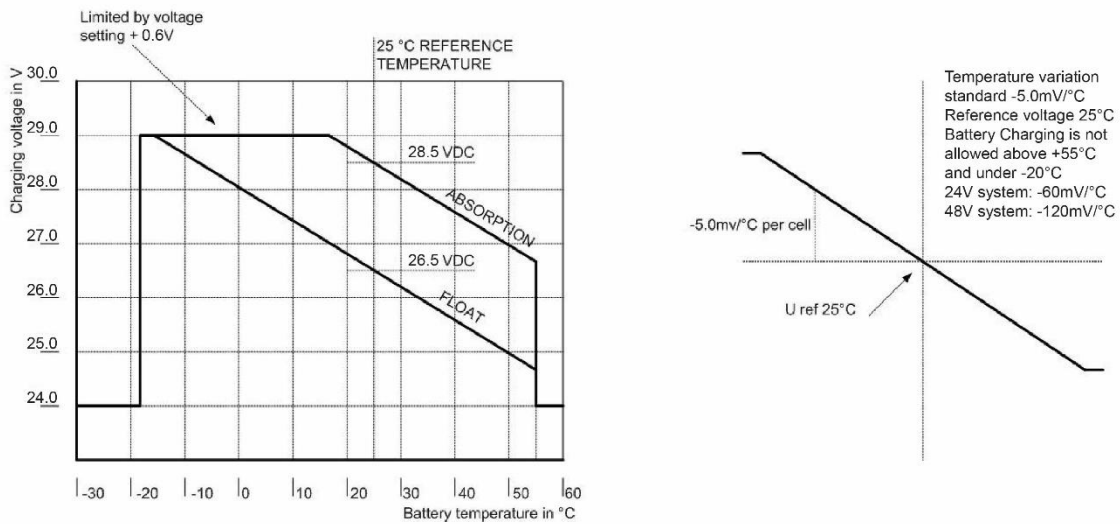

Figure 11. Temperature compensation characteristic (charge voltage versus temperature)



We welcome your feedback and suggestions!

Send feedback on this document to [info@mastervolt.com](mailto:info@mastervolt.com)

**Europe, Middle East & Africa**

**Technical Support**

T: +31 (0) 20 34 22 100

E: [ts.emea@OneASG.com](mailto:ts.emea@OneASG.com)

**Location & Shipping**

Navico Group EMEA

Snijdersbergweg 93

1105 AN Amsterdam

The Netherlands

**Americas & Caribbean**

**Technical Support**

T: +1 262 293 0600 / 800 307 6702

E: [tech.mastervolt@OneASG.com](mailto:tech.mastervolt@OneASG.com)

**Location & Shipping**

Navico Group US

N85 W12545 Westbrook Crossing

Menomonee Falls, WI 53051

United States

**Asia Pacific**

**Technical Support**

T: +64 9 415 7261

E: [technical.apac@OneASG.com](mailto:technical.apac@OneASG.com)

**Location & Shipping**

Navico Group APAC

42 Apollo Drive

Rosedale, Auckland 0632

New Zealand

*Document version: 10000001888/05 (December 23)*

*Copyright ©2023 Navico Group EMEA B.V. All rights reserved.*