

MMR-25W

Wireless Remote Controller
with Bluetooth® Technology

Télécommande sans fil avec technologie Bluetooth®

Mando a distancia inalámbrico con tecnología Bluetooth®

Funkfernbedienung mit Bluetooth®-Technologie

Controller remoto wireless con tecnologia Bluetooth®

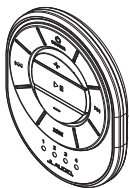

x1



x1



x1



x2



x1

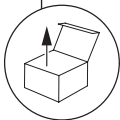

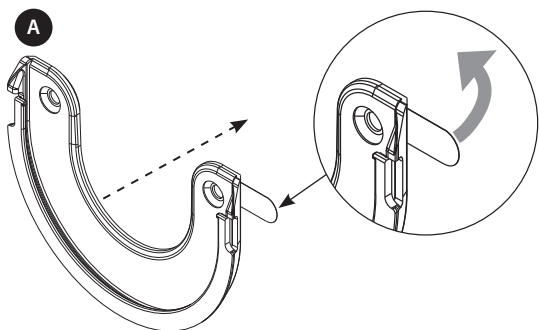
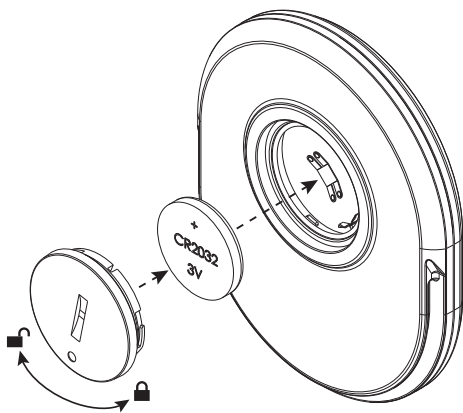

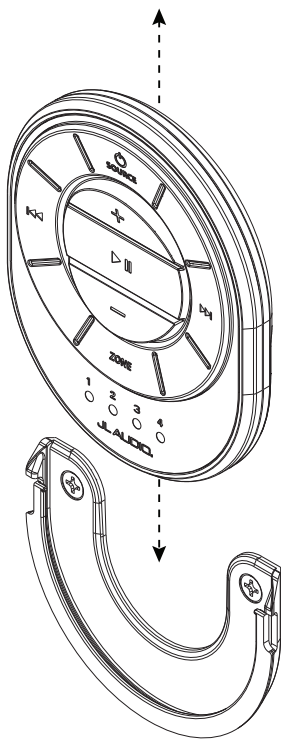

B

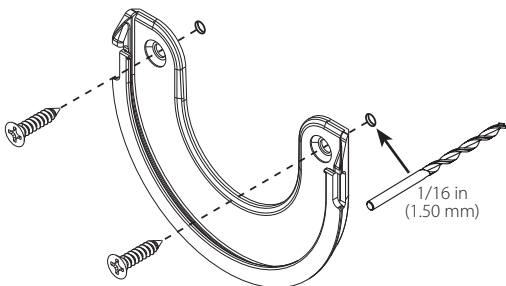



- Do not ingest battery, Chemical Burn Hazard.
- This product contains a coin/button cell battery. If the coin/button cell battery is swallowed, it can cause severe internal burns in just 2 hours and can lead to death.
- Keep new and used batteries away from children.
- If the battery compartment does not close securely, stop using the product and keep it away from children.
- If you think batteries might have been swallowed or placed inside any part of the body, seek immediate medical attention.

Installation Considerations







- Installation requires appropriate tools and safety equipment. Professional installation is recommended.
- This product is water-resistant. Do not submerge or subject to high-pressure water spray.
- Do not mount in areas of extreme heat.
- Mount this product securely to prevent damage or injury in severe conditions.
- Before cutting or drilling, check for potential obstacles behind mounting surfaces.

Pairing Remotes

Up to eight remotes* can be paired to a single source unit, with each operating up to 35 ft (11 m) away. Additional remotes sold separately.

1	• Initiate Remote Pairing Mode from your MediaMaster® settings	
2		• Press for 5 seconds on MMR-25W to enter Remote Pairing Mode Zone LEDs will pulse slowly
		• Short press to exit Remote Pairing Mode

*Includes total capacity of ALL paired Bluetooth® devices (remotes, streaming sources, app controllers, etc.).

General Controls	
 SOURCE	• Short press to turn ON • Long press to turn OFF • Short press to advance through available sources
	• Short press to mute/unmute or pause/resume audio • Press for 5 seconds to enter Remote Pairing Mode
	• Short press to increase volume • Long press to increase volume continuously
	• Short press to decrease volume • Long press to decrease volume continuously
 ZONE 1 2 3 4	• Short press to select the next zone for volume adjustment • Press for 5 seconds to lock/unlock on the current zone
	• Short press to select the next Favorite or track • Long press to seek/fast-forward
	• Short press to select the previous Favorite or track • Long press to seek/fast-rewind

Note: Control functionality will vary by the connected host source unit.

AVERTISSEMENT

- Ne pas ingérer la pile, risque de brûlure chimique.
- Ce produit contient une pile bouton/de montre. Si la pile bouton/de montre est avalée, elle risque de provoquer de graves brûlures internes en seulement 2 heures et peut entraîner la mort.
- Conserver les piles neuves et usagées hors de portée des enfants.
- Si le compartiment de la pile ne ferme pas correctement, ne plus utiliser le produit et le garder hors de portée des enfants.
- Si vous pensez que des piles ont pu être avalées ou introduites dans une partie du corps, consultez immédiatement un médecin.

Considérations relatives à l'installation







- L'installation nécessite des outils et des équipements de sécurité appropriés. Une installation par un professionnel est recommandée.
- Ce produit résiste à l'eau. Ne pas l'immerger ni le soumettre à un jet d'eau à haute pression.
- Ne pas l'installer dans des zones de chaleur extrême.
- Fixer correctement ce produit pour éviter tout risque de dommages ou de blessures graves.
- Avant de procéder au découpage ou au perçage, vérifier l'absence d'obstacles potentiels derrière les surfaces de montage.

Appairage des télécommandes

Il est possible d'associer jusqu'à huit télécommandes* à une seule source, chacune pouvant fonctionner jusqu'à 11 m (35 pi) de distance. Télécommandes supplémentaires vendues séparément.

1	• Lancer le mode d'appairage à distance à partir des paramètres de votre MediaMaster*	
2		<ul style="list-style-type: none"> • Appuyer 5 secondes sur ce bouton sur la télécommande MMR-25W pour passer en mode d'appairage à distance
		<ul style="list-style-type: none"> • Appuyer brièvement sur ce bouton pour quitter le mode d'appairage à distance

Capacité totale de TOUS les appareils Bluetooth appairés (télécommandes, sources de streaming, contrôleurs d'applications, etc.).

Commandes générales	
 SOURCE	<ul style="list-style-type: none"> • Appuyer brièvement sur ce bouton pour allumer l'appareil • Appuyer longuement sur ce bouton pour éteindre l'appareil • Appuyer brièvement sur ce bouton pour faire défiler les sources disponibles
	<ul style="list-style-type: none"> • Appuyer brièvement pour couper/rétablir le son ou le mettre en pause/repandre • Appuyer 5 secondes sur ce bouton pour passer en mode d'appairage à distance
	<ul style="list-style-type: none"> • Appuyer brièvement sur ce bouton pour augmenter le volume • Appuyer longuement sur ce bouton pour augmenter le volume en continu
	<ul style="list-style-type: none"> • Appuyer brièvement sur ce bouton pour diminuer le volume • Appuyer longuement sur ce bouton pour diminuer le volume en continu
 ZONE 1 2 3 4	<ul style="list-style-type: none"> • Appuyer brièvement sur un bouton pour sélectionner la zone suivante pour laquelle régler le volume • Appuyer pendant 5 secondes sur ce bouton pour verrouiller/déverrouiller la zone actuelle
	<ul style="list-style-type: none"> • Appuyer brièvement sur ce bouton pour sélectionner la piste suivante ou le favori suivant • Appuyer longuement sur ce bouton pour effectuer une recherche/une avance rapide
	<ul style="list-style-type: none"> • Appuyer brièvement sur ce bouton pour sélectionner la piste précédente ou le favori précédent • Appuyer longuement sur ce bouton pour effectuer une recherche/un retour en arrière rapide

Remarque : les fonctionnalités des commandes varient selon l'unité source hôte connectée.

 **ADVERTENCIA**

- No ingiera la batería, peligro de quemadura química.
- Este producto contiene una pila de botón. Si se ingiere la pila de botón, puede causar graves quemaduras internas en solo 2 horas e incluso provocar la muerte.
- Mantenga las pilas nuevas y usadas fuera del alcance de los niños.
- Si el compartimento de las pilas no cierra correctamente, deje de utilizar el producto y manténgalo alejado de los niños.
- Si cree alguien puede haber ingerido pilas o puede haberlas introducido en cualquier orificio del cuerpo, consiga atención médica inmediatamente.

Consideraciones sobre la instalación

- Para la instalación se requieren herramientas y equipos de seguridad adecuados. Se recomienda que la instalación la realice un profesional.
- Este producto es resistente al agua. No se debe sumergir ni rociar con agua a alta presión.
- No se debe montar en zonas de calor extremo.
- Monte este producto de forma segura para evitar daños o lesiones en condiciones extremas.
- Antes de cortar o taladrar, compruebe que no haya obstáculos detrás de las superficies de montaje.

Emparejar controles

Se pueden emparejar hasta ocho controles* con una sola unidad fuente, y cada uno puede funcionar a una distancia de hasta 35 ft (11 m). Los controles remotos adicionales se venden por separado.

1	• Inicie el modo de emparejamiento remoto desde la configuración de su MediaMaster®.		
2		• Presiónelo durante 5 segundos en el MMR-25W para activar el modo de emparejamiento remoto.	Los LED de la zona parpadearán lentamente.
		• Presiónelo brevemente para salir del modo de emparejamiento remoto.	

*Incluye la capacidad total de TODOS los dispositivos Bluetooth® emparejados (controles remotos, fuentes de transmisión, controladores de aplicaciones, etc.).

Controles generales	
 SOURCE	<ul style="list-style-type: none"> • Presiónelo brevemente para encenderlo. • Presiónelo y manténgalo presionado para apagarlo. • Presiónelo brevemente para cambiar entre las fuentes disponibles.
	<ul style="list-style-type: none"> • Presiónelo brevemente para silenciar/reactivar o pausar/reanudar el audio. • Presiónelo durante 5 segundos para activar el modo de emparejamiento remoto.
	<ul style="list-style-type: none"> • Presiónelo brevemente para subir el volumen. • Presiónelo y manténgalo presionado para subir el volumen rápidamente.
	<ul style="list-style-type: none"> • Presiónelo brevemente para bajar el volumen. • Presiónelo y manténgalo presionado para bajar el volumen rápidamente.
ZONE 	<ul style="list-style-type: none"> • Presiónelo brevemente para cambiar a la siguiente zona y ajustar el volumen de esa zona. • Presiónelo durante 5 segundos para bloquear/desbloquear la zona actual.
	<ul style="list-style-type: none"> • Presiónelo brevemente para seleccionar el favorito o la pista siguiente. • Presiónelo y manténgalo presionado para avanzar rápidamente.
	<ul style="list-style-type: none"> • Presiónelo brevemente para seleccionar el favorito o la pista anterior. • Presiónelo y manténgalo presionado para retroceder rápidamente.

Nota: La funcionalidad del control variará en función de la unidad fuente anfitriona conectada.

 **WARNHINWEIS**

- Batterie nicht verschlucken, Verätzungsgefahr.
- Dieses Produkt enthält eine Knopfzellenbatterie. Wenn die Knopfzellenbatterie verschluckt wird, kann dies innerhalb von lediglich 2 Stunden zu schweren inneren Verätzungen und Tod führen.
- Halten Sie neue und gebrauchte Batterien von Kindern fern.
- Wenn sich das Batteriefach nicht sicher schließen lässt, das Produkt nicht mehr verwenden und von Kindern fernhalten.
- Wenn Sie glauben, dass Batterien verschluckt oder in irgendeinen Körperteil eingeführt wurden, suchen Sie sofort einen Arzt auf.

Hinweise zur Installation







- Die Installation erfordert geeignete Werkzeuge und Sicherheitsausrüstung. Die Installation durch eine Fachkraft wird empfohlen.
- Dieses Produkt ist wasserfest. Nicht eintauchen oder einem Hochdruck-Wasserstrahl aussetzen.
- Nicht in Bereichen mit extrem hohen Temperaturen montieren.
- Achten Sie auf eine sichere Befestigung dieses Produkts, um Beschädigungen oder Verletzungen unter anspruchsvollen Bedingungen zu vermeiden.
- Kontrollieren Sie vor dem Schneiden oder Bohren, ob sich hinter den Montageflächen mögliche Hindernisse befinden.

Koppeln der Fernbedienungen

Bis zu acht Fernbedienungen* können mit einem einzelnen Quellgerät gekoppelt und in einer Entfernung von jeweils bis zu 11 m betrieben werden. Zusätzliche Fernbedienungen sind separat erhältlich.

1	• Starten Sie den Remote-Kopplungsmodus über Ihre MediaMaster®-Einstellungen	
2		<ul style="list-style-type: none"> • Drücken Sie 5 Sekunden lang auf das MMR-25W, um in den Remote-Pairing-Modus zu wechseln • Kurz drücken, um den Remote-Pairing-Modus zu verlassen
		Die Zonen-LEDs blinken langsam

*Umfasst die Gesamtkapazität ALLER gekoppelten Bluetooth®-Geräte (Fernbedienungen, Streaming-Quellen, App-Controller usw.).

Allgemeine Bedienelemente	
 SOURCE	<ul style="list-style-type: none"> • Zum Einschalten kurz drücken • Zum Ausschalten lange drücken • Kurz drücken, um die verfügbaren Quellen zu überfliegen
	<ul style="list-style-type: none"> • Kurz drücken, um Audio stumm zu schalten/laut zu schalten oder Wiedergabe anzuhalten/fortzusetzen • 5 Sekunden lang drücken, um in den Remote-Pairing-Modus zu wechseln
	<ul style="list-style-type: none"> • Kurz drücken, um die Lautstärke zu erhöhen • Lang drücken, um die Lautstärke kontinuierlich zu erhöhen
	<ul style="list-style-type: none"> • Kurz drücken, um die Lautstärke zu verringern • Lang drücken, um die Lautstärke kontinuierlich zu verringern
 ZONE	<ul style="list-style-type: none"> • Kurz drücken, um die nächste Zone für die Lautstärkeeinstellung auszuwählen • 5 Sekunden lang drücken, um die aktuelle Zone zu sperren/entsperren
	<ul style="list-style-type: none"> • Kurz drücken, um den nächste Favouriten oder Titel anzuwählen • Lang Drücken zum Suchen/Schnellvorlauf
	<ul style="list-style-type: none"> • Kurz drücken, um den vorherigen Favouriten oder Titel anzuwählen • Lang Drücken zum Suchen/Schnellrücklauf

Hinweis: Die Steuerungsfunktionalität hängt vom angeschlossenen Host-Quellgerät ab.

AVVERTENZA

- Non ingerire la batteria. Sussiste il pericolo di ustione chimica.
- Questo prodotto contiene una batteria/pila a bottone. Se la batteria/pila a bottone viene ingerita, può causare ustioni interne gravi in appena 2 ore e può causare la morte.
- Tenere le batterie nuove e usate lontano dai bambini.
- Se il vano della batteria non si chiude saldamente, interrompere l'utilizzo del prodotto e tenerlo lontano dai bambini.
- Se si pensa che le batterie siano state ingerite o collocate in qualsiasi parte del corpo, contattare subito un medico.

Considerazioni sull'installazione

- Per l'installazione sono richiesti strumenti e attrezzature di sicurezza idonei. Si consiglia l'installazione da parte di un professionista.
- Questo prodotto è idrorepellente. Non immergere né esporre a spruzzi di acqua ad alta pressione.
- Non installare in aree con calore estremo.
- Installare questo prodotto in sicurezza, al fine di prevenirne danni o lesioni in condizioni gravi.
- Prima di effettuare eventuali tagli o fori, verificare la presenza di eventuali ostacoli dietro le superfici di montaggio.



Abbinamento dei telecomandi

È possibile abbinare fino a otto telecomandi* a un'unica unità sorgente, ciascuno con una distanza operativa fino a 35 ft (11 m). Telecomandi aggiuntivi sono venduti separatamente.

1	• Avviare la modalità di abbinamento remoto consultando le impostazioni MediaMaster®	
2	▶	<ul style="list-style-type: none"> • Premere per 5 secondi sul MMR-25W per accedere alla modalità di abbinamento remoto • Premere brevemente per uscire dalla modalità di abbinamento remoto

I LED Zone lampeggeranno lentamente

*Include la capacità totale di TUTTI i dispositivi Bluetooth® abbinati (telecomandi, sorgenti di riproduzione, controller di app, ecc.).

Comandi generali	
 SOURCE	<ul style="list-style-type: none"> • Premere brevemente per accendere • Premere a lungo per spegnere • Premere brevemente per scorrere tra le sorgenti disponibili
▶	<ul style="list-style-type: none"> • Premere brevemente per tacitare/attivare o interrompere/riprendere l'audio • Premere per 5 secondi per accedere alla modalità di abbinamento remoto
+	<ul style="list-style-type: none"> • Premere brevemente per aumentare il volume • Premere a lungo per aumentare costantemente il volume
-	<ul style="list-style-type: none"> • Premere brevemente per ridurre il volume • Premere a lungo per ridurre costantemente il volume
ZONE 	<ul style="list-style-type: none"> • Premere brevemente per selezionare la zona successiva per la regolazione del volume • Premere per 5 secondi per bloccare/sbloccare la zona attuale
▶▶	<ul style="list-style-type: none"> • Premere brevemente per selezionare il preferito o il brano successivo • Premere a lungo per cercare/scorrere in avanti
◀◀	<ul style="list-style-type: none"> • Premere brevemente per selezionare il preferito o il brano precedente • Premere a lungo per cercare/scorrere indietro

Nota: La funzione di controllo varia in base all'unità sorgente host collegata.