

Quick®

High Quality Nautical Equipment

PONTOON

PT 350 R
PT 350 G
PT 700 R
PT 700 G
PT 1000 R
PT 1000 G

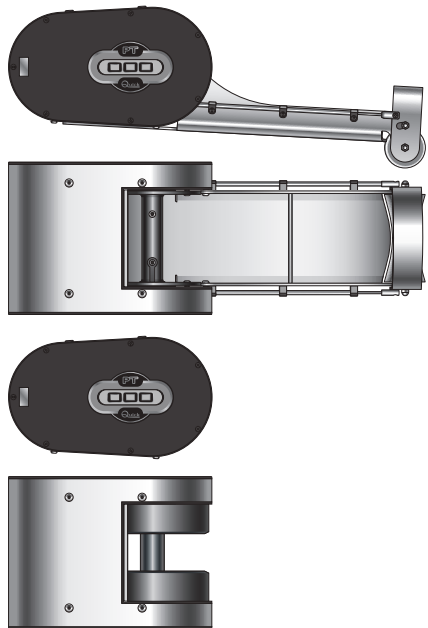

IT Manuale di installazione ed uso
EN Manual of installation and use
FR Mode d'emploi et d'installation
DE Installations- und Benutzerhandbuch
ES Manual de instalación y uso

SALPA ANCORA ON-DECK
ON-DECK WINDLASSES
GUINDEAUX ON-DECK
ON-DECK ANKERWINDEN
MOLINETES ON-DECK

**IT****INDICE**

Pag. 4	Caratteristiche tecniche	Pag. 10	Schema di collegamento PTR 700 con bow-roller
Pag. 5	Caratteristiche - Installazione	Pag. 11	Schema di collegamento generale PTR 700 con bow-roller
Pag. 6	Schema di collegamento PTR-PTG 350	Pag. 12	Manutenzione
Pag. 7	Schema di collegamento generale PTR-PTG 350	Pag. 13	Manutenzione
Pag. 8	Schema di collegamento PTR 700/1000		
Pag. 9	Schema di collegamento generale PTR 700/1000		

EN**INDEX**

Pag. 14	Technical data	Pag. 20	Connection diagram PTR-PTG 700 with Bow-Roller
Pag. 15	Characteristics - Installation	Pag. 21	General connection diagram PTR-PTG 700 with Bow-Roller
Pag. 16	Connection diagram PTR-PTG 350	Pag. 22	Maintenance
Pag. 17	General connection diagram PTR-PTG 350	Pag. 23	Maintenance
Pag. 18	Connection diagram PTR-PTG 700/1000		
Pag. 19	General connection diagram PTR-PTG 700/1000		

FR**SOMMAIRE**

Pag. 14	Caractéristiques techniques	Pag. 20	Schema de cablage PTR-PTG 700 avec Bow-Roller
Pag. 15	Characteristics - Installation	Pag. 21	Schema de cablage general PTR-PTG 700 avec Bow-Roller
Pag. 16	Schema de cablage PTR-PTG 350	Pag. 22	Entretien
Pag. 17	Schema de cablage general PTR-PTG 350	Pag. 23	Entretien
Pag. 18	Schema de cablage PTR-PTG 700/1000		
Pag. 19	Schema de cablage general PTR-PTG 700/1000		

DE**INHALTSANGABE**

Pag. 14	Technische Eigenschaften	Pag. 20	Anschlussplan PTR-PTG 700 mit Bow-Roller
Pag. 15	Eigenschaften - Installation	Pag. 21	Allgemeine Anschlussplan PTR-PTG 700 mit Bow-Roller
Pag. 16	Anschlussplan PTR-PTG 350	Pag. 22	Wartung
Pag. 17	Allgemeine Anschlussplan PTR-PTG 350	Pag. 23	Wartung
Pag. 18	Anschlussplan PTR-PTG 700/1000		
Pag. 19	Allgemeine Anschlussplan PTR-PTG 700/1000		

ES**INDICE**

Pag. 14	Características técnicas	Pag. 20	Diagrama de conexión PTR-PTG 700 con Bow-Roller
Pag. 15	Características - Instalación	Pag. 21	Diagrama general de conexión PTR-PTG 700 con Bow-Roller
Pag. 16	Diagrama de conexión PTR-PTG 350	Pag. 22	Mantenimiento
Pag. 17	Diagrama general de conexión PTR-PTG 350	Pag. 23	Mantenimiento
Pag. 18	Diagrama de conexión PTR-PTG 700/1000		
Pag. 19	Diagrama general de conexión PTR-PTG 700/1000		



MODELLI PONTOON	PT 350 R - PT 350 G	PT 700 R - PT 700 G	PT 1000 R - PT 1000 G
POTENZA MOTORE	150 W	250 W	350 W
TENSIONE MOTORE	12 V	12 V	24 V
Tiro istantaneo massimo	260 kg (573,2 lb)	600 kg (1322,7 lb)	750 kg (1653,4 lb)
Carico di lavoro massimo	100 kg (220,4 lb)	220 kg (485,0 lb)	250 kg (551,0 lb)
Carico di lavoro	40 kg (88,1 lb)	80 kg (176,3 lb)	100 kg (220,4 lb)
Assorbimento corrente al carico di lavoro (1)	13 A	22 A	16 A
Velocità max di recupero (2)	20,8 m/min (68,2 ft/min)	20,8 m/min (68,2 ft/min)	21,5 m/min (70,5 ft/min)
Velocità di recupero al carico di lavoro (2)	19,3 m/min (63,3 ft/min)	18,1 m/min (59,3 ft/min)	18,3 m/min (60,0 ft/min)
Sezione minima cavi motore (3)	10 mm ² (AWG7)		
Interruttore di protezione (4)	20 A	30 A	20 A
Spessore coperta (5)	20 ÷ 40 mm (3/4" ÷ 1" 9/16 ft)		
Peso	10 kg - 22 lb	10,2 kg - 22,4 lb	10,2 kg - 22,4 lb

(1) Dopo un primo periodo d'uso.

(2) Misure effettuate con cima da 6 mm.

(3) Valore minimo consigliato per una lunghezza totale L = <20m (vedi schemi di collegamento). Calcolare la sezione del cavo in funzione della lunghezza del collegamento.

(4) Con interruttore specifico per correnti continue (DC) e ritardato (magneto-termico o magneto-idraulico).

(5) Su richiesta possono essere forniti prigionieri per spessori di coperta maggiori.

DIMENSIONI DEI MODELLI mm (inch)

PT 350 R - PT 700 R - PT 1000 R

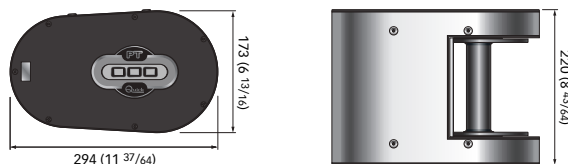

PTR CON ACCESSORIO BOW-ROLLER (SOLO MODELLI 350 - 1000)

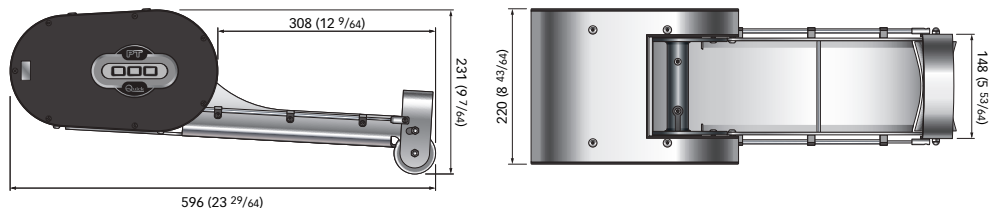

PT 350 G - PT 700 G - PT 1000 G

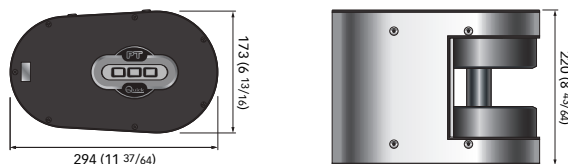

Quick® si riserva il diritto di apportare modifiche alle caratteristiche tecniche dell'apparecchio e al contenuto di questo manuale senza alcun preavviso. In caso di discordanze o eventuali errori tra il testo tradotto e quello originario in italiano, fare riferimento al testo italiano o inglese.



PRIMA DI UTILIZZARE IL SALPA ANCORA LEGGERE ATTENTAMENTE IL PRESENTE MANUALE D'USO. IN CASO DI DUBBI CONSULTARE IL RIVENDITORE QUICK®.



ATTENZIONE • I salpa ancora Quick® sono stati progettati e realizzati per salpare l'ancora.

- Non utilizzare questi apparecchi per altri tipi di operazioni.
- Quick® non si assume alcuna responsabilità per i danni diretti o indiretti causati da un uso improprio dell'apparecchio.
- Il salpa ancora non è progettato per sostenere carichi generati in particolari condizioni atmosferiche (burrasca).
- Disattivare sempre il salpa ancora quando non è in uso.
- Accertarsi che non vi siano bagnanti nelle vicinanze prima di calare l'ancora.
- Per maggiore sicurezza, nel caso in cui uno si danneggi suggeriamo di installare almeno due comandi per l'azionamento del salpa ancora.
- Consigliamo l'uso dell'interruttore magneto-idraulico Quick® come sicurezza per il motore.
- La scatola teleinvertitori deve essere installata in un luogo protetto da possibili entrate d'acqua.
- Dopo aver completato l'ancoraggio, fissare la catena o cima a punti fissi quali chian stopper o bitta.
- Per prevenire rilasci non voluti l'ancora deve essere fissata, il salpa ancora non deve essere usato come unica presa di forza.
- Isolare il salpa ancora dall'impianto elettrico durante la navigazione (disinserire l'interruttore di protezione del motore) e bloccare la cima ad un punto fisso dell'imbarcazione.

LA CONFEZIONE CONTIENE: salpa ancora PTG o PTR - cassetta teleinvertitori (solo mod. 700/1000) - 30 m di cima Dyneema (solo PTR) - dima di foratura - viterie (per l'assemblaggio) - manuale d'uso - condizioni di garanzia.

ATTREZZI NECESSARI PER L'INSTALLAZIONE: trapano con punte: Ø 9 mm (23/64"), Ø 15 mm (63/64"); chiave esagonale: 13 mm.

ACCESSORI QUICK® CONSIGLIATI: deviatore da pannello (mod. 800 - WCS 810) - Pulsantiera stagna (mod. HRC1002) - Pulsante a piede (mod. 900) - Fettuccia con moschettoni (solo PTG) - Sistema di comando via radio RRC (mod. R02, P02, H02).

REQUISITI PER L'INSTALLAZIONE PTG

Il salpa ancora va posizionato allineando la fettuccia (quindi il centro del salpa) con il gancio del tender da sollevare. Verificare che le superfici, superiore ed inferiore della coperta, siano più parallele possibili; se ciò non dovesse accadere compensare opportunamente la differenza (la mancanza di parallelismo potrebbe causare un montaggio non sicuro).

Lo spessore di coperta dovrà essere compreso fra i vari valori indicati in tabella.

Se si avessero spessori differenti è necessario consultare il rivenditore Quick®.

REQUISITI PER L'INSTALLAZIONE PTR

Il salpa ancora va posizionato allineando il rocchetto con il bow roller. Se il bow roller è già montato, assicurarsi che sporga dalla prua (o dalla poppa) affinché la discesa e la risalita dell'ancora nel bow roller non incontri ostacoli. Verificare che le superfici superiore ed inferiore della coperta siano più parallele possibili; se ciò non dovesse accadere compensare opportunamente la differenza (la mancanza di parallelismo potrebbe causare un montaggio non sicuro).

Lo spessore di coperta dovrà essere compreso fra i vari valori indicati in tabella.

Se si avessero spessori differenti è necessario consultare il rivenditore Quick®.

INSTALLAZIONE

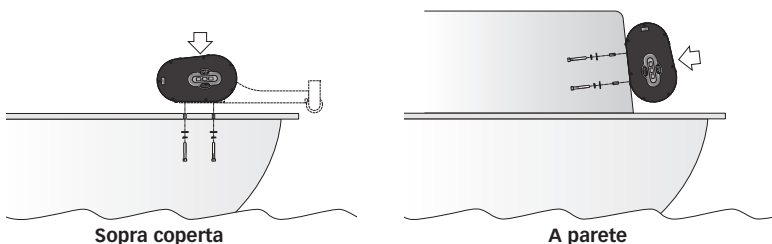

PROCEDURA DI MONTAGGIO

Stabilita la posizione ideale (sopra coperta o a parete) praticare i fori utilizzando la dima di foratura fornita a corredo. Rimuovere il materiale in eccesso dai fori poi rifinirli e lisciarli con un prodotto specifico (vernice marittima, gel o resina epossidica). Posizionare il salpa ancora facendo attenzione al passaggio dei cavi di potenza e di comando. Avvitare i prigionieri al salpa ancora. Fissare il salpa ancora avvitando i dadi sui prigionieri di bloccaggio. Collegare i cavi di alimentazione provenienti dal salpa ancora al teleinvertitore (o alla batteria nel caso il teleinvertitore sia integrato).



ATTENZIONE: prima di effettuare il collegamento accertarsi che non sia presente l'alimentazione su cavi.



**SISTEMA BASE
CON ACCESSORI QUICK® CONSIGLIATI
PER IL FUNZIONAMENTO DEL SALPA ANCORA**

PT 350 R (versione con o senza Bow-roller)
PT 350 G

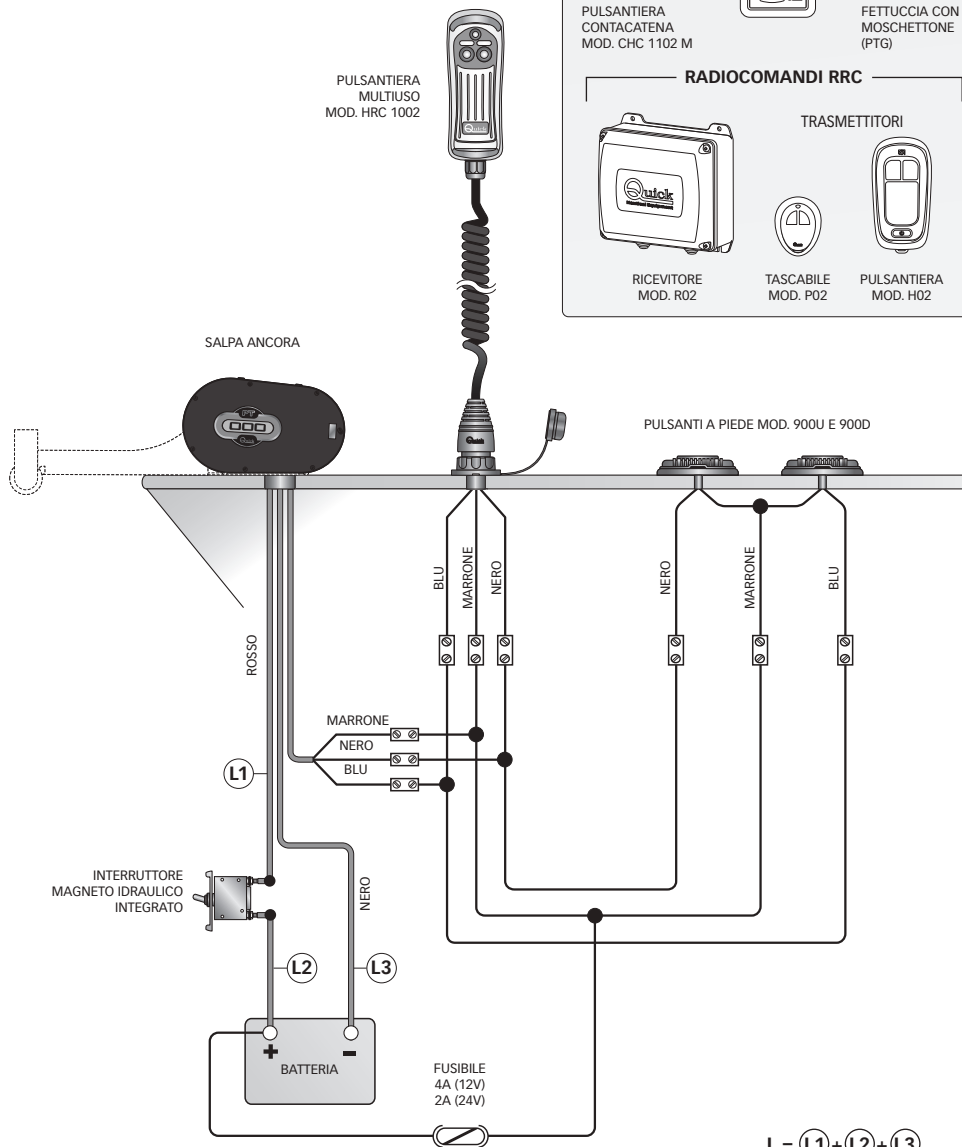
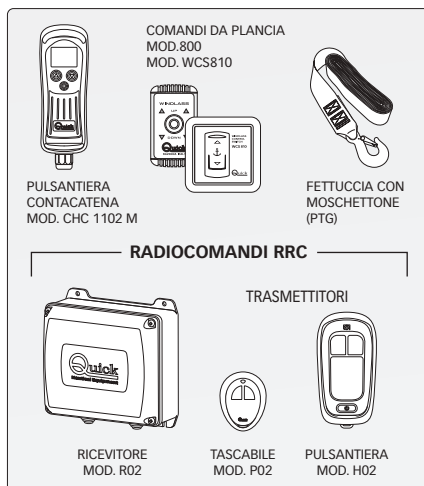



SISTEMA BASE
CON ACCESSORI QUICK® CONSIGLIATI
PER IL FUNZIONAMENTO DEL SALPA ANCORA

PT 700 R - PT 1000 R
 PT 700 G - PT 1000 G

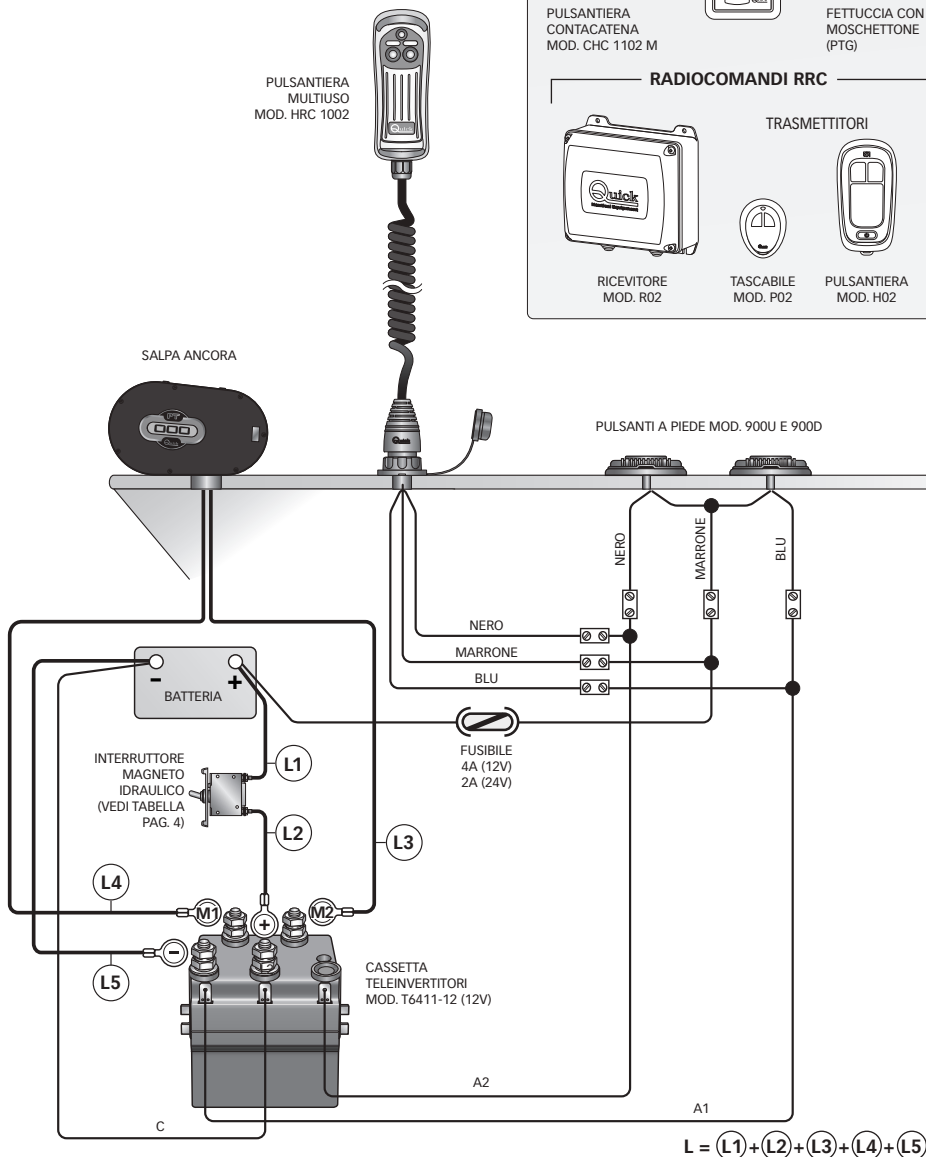
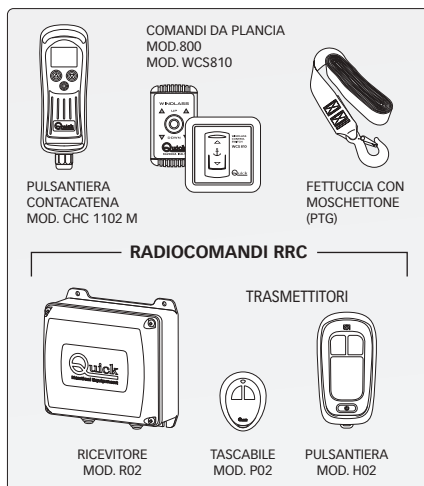



SCHEMA DI COLLEGAMENTO GENERALE

IT

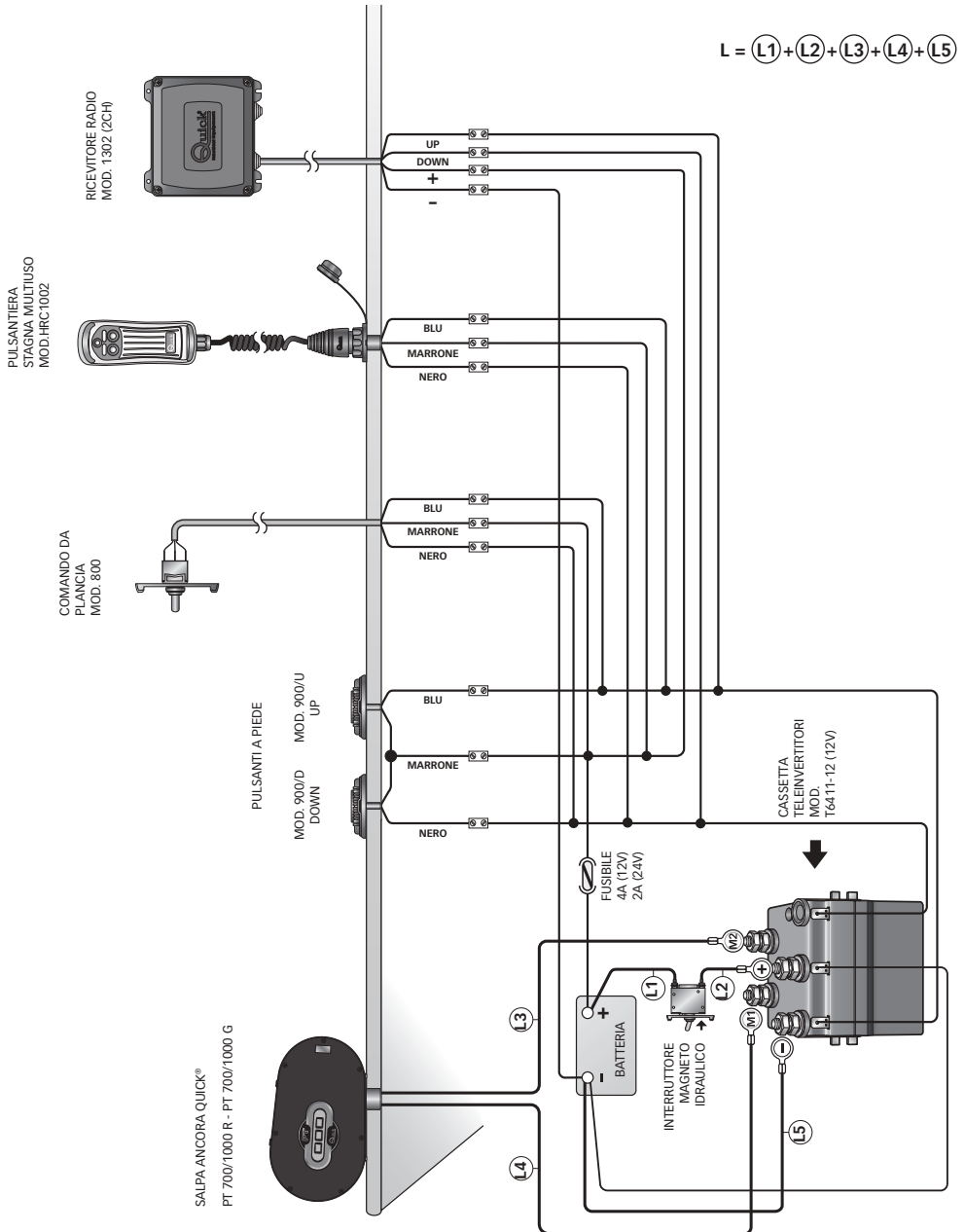



**SISTEMA BASE
CON ACCESSORI QUICK® CONSIGLIATI
PER IL FUNZIONAMENTO DEL SALPA ANCORA**

PT 700 R con Bow-Roller

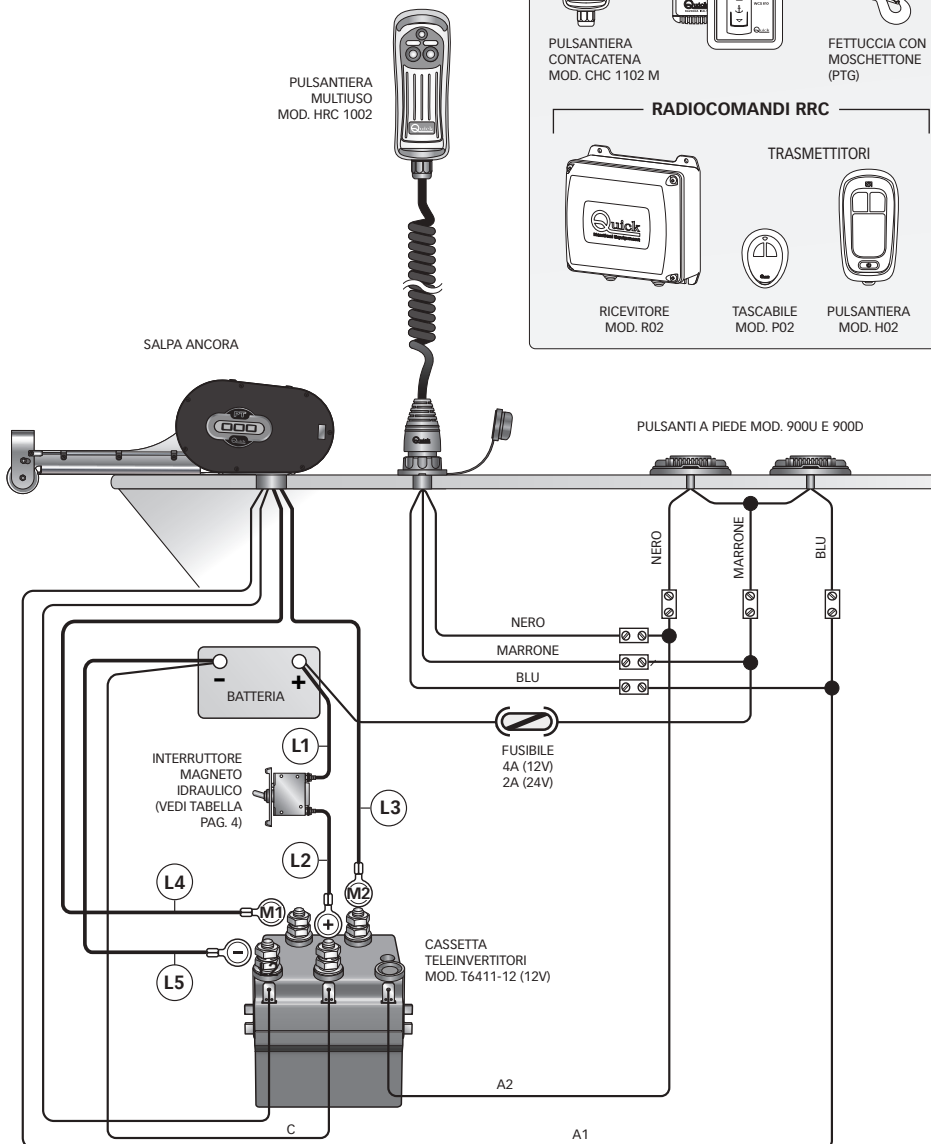

COMANDI DA PLANCIA
MOD. 800
MOD. WCS810

PULSANTE
CONTACATENA
MOD. CHC 1102 M

FETTUCCIA
CON
MOSCHETTONE
(PTG)

RADIOCOMANDI RRC

RICEVITORE
MOD. R02

TRASMETTITORI

TASCABILE
MOD. P02

PULSANTE
MOD. H02

$$L = (L1) + (L2) + (L3) + (L4) + (L5)$$



SCHEMA DI COLLEGAMENTO GENERALE

IT

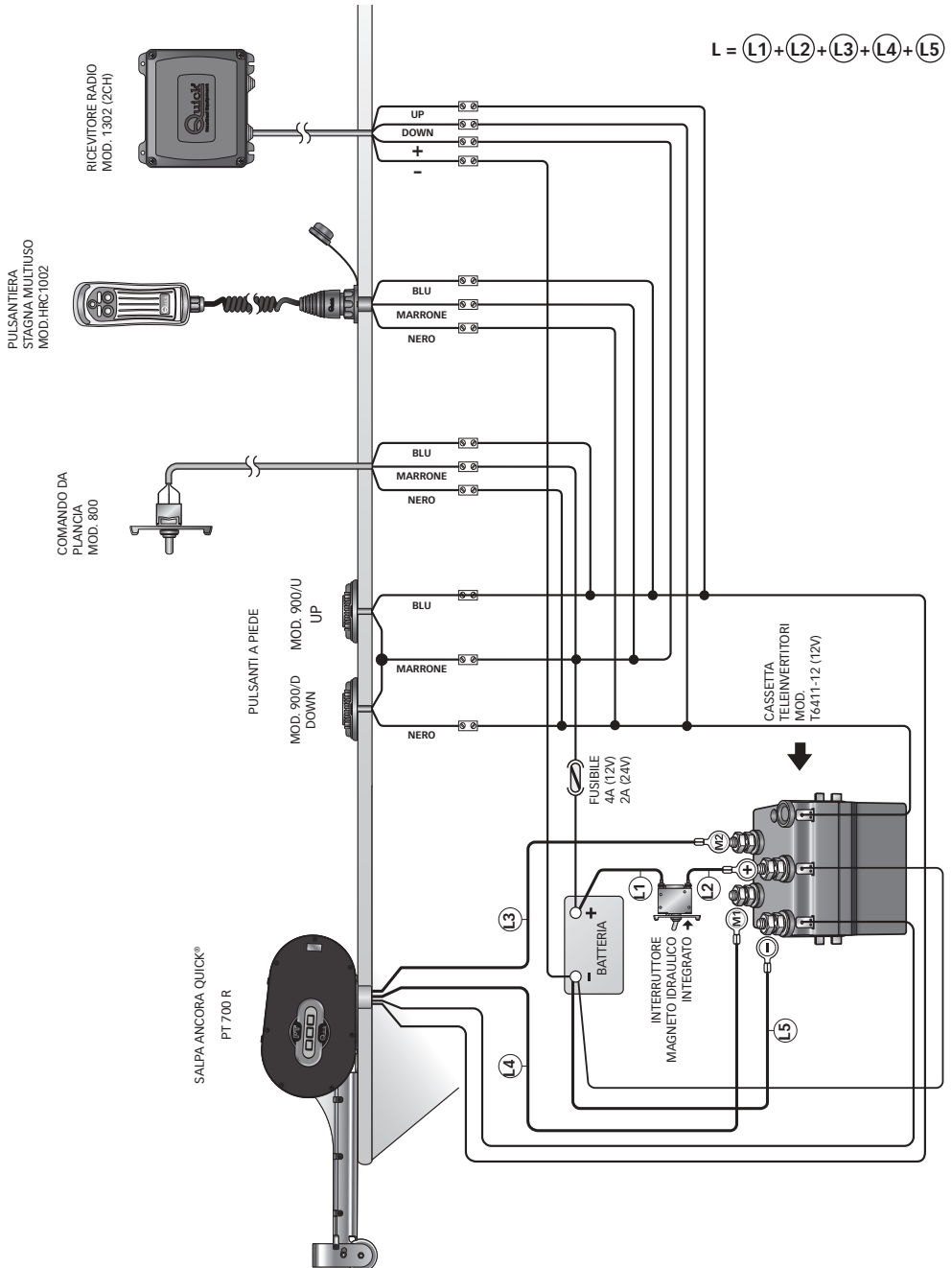



PONTOON 350 -700-1000

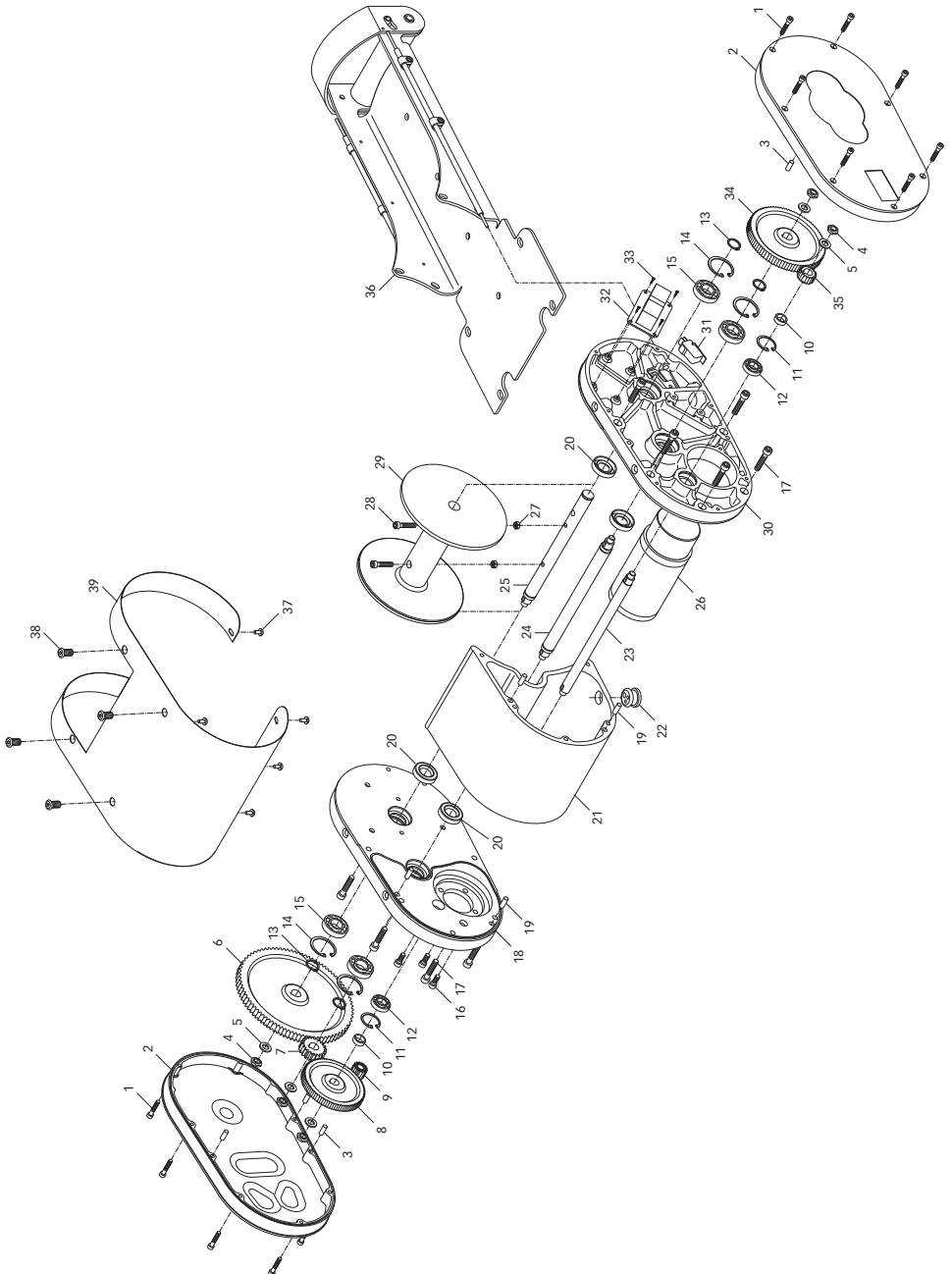



POS.	DENOMINAZIONE
1	VITE
2	CARTER SALPA SERIE "PT PLAST"
3	SPINA
4	DADO
5	RONDELLA
6	RUOTA Z100 M1.5
7	RUOTA Z20 M1.5
8	RUOTA Z80 M1
9	RUOTA Z16 M1
10	DISTANZIALE PT
11	ANELLO ELASTICO INTERNO
12	CUSCINETTO
13	ANELLO ELASTICO ESTERNO
14	ANELLO ELASTICO INTERNO
15	CUSCINETTO
16	VITE
17	VITE
18	BASE SALPA SERIE PT
19	SPINA
20	PARAOLIO
21	ESTRUSO SALPA SERIE PT
22	PASSACAVO PT
23	ALBERO SERIE PT 1
24	ALBERO SERIE PT 2
25	ALBERO SERIE PT 3
26A	MOTORE SALPA ANCORA 150W 12V PT
26B	MOTORE SALPA ANCORA 250W 12V PT
26C	MOTORE SALPA ANCORA 350W 24V PT
27	DADO
28	VITE
29	ROCCHETTO SALPA SERIE "PT PLAST"
30	BASE SALPA SERIE PT
31	PULSANTE MICROSWITCH 16A/250W
32	SCHEDA TELENIV RELE 45A
33	VITE
34	RUOTA Z100 M1
35	RUOTA Z20 M1
36	BOW ROLLER PT COMPLETO INOX
37	VITE
38	VITE
39	COVER BASE SERIE PT INOX

 **ATTENZIONE:** accertarsi che non sia presente l'alimentazione al motore elettrico quando si opera manualmente sul salpa ancora; rimuovere con cura la cima dal rocchetto.

I salpa ancora Quick® sono costituiti da materiali resistenti all'ambiente marino: è indispensabile, in ogni caso, rimuovere periodicamente i depositi di sale che si formano sulle superfici esterne per evitare corrosioni e di conseguenza danni all'apparecchio.

Lavare accuratamente con acqua dolce le superfici e le parti in cui il sale può depositarsi.



MODELS PONTOON	PT 350 R - PT 350 G	PT 700 R - PT 700 G	PT 1000 R - PT 1000 G
MOTOR OUTPUT	150 W	250 W	350 W
MOTOR SUPPLY VOLTAGE	12 V	12 V	24 V
Maximum pull	260 kg (573,2 lb)	600 kg (1322,7 lb)	750 kg (1653,4 lb)
Maximum working load	100 kg (220,4 lb)	220 kg (485,0 lb)	250 kg (551,0 lb)
Working load	40 kg (88,1 lb)	80 kg (176,3 lb)	100 kg (220,4 lb)
Current absorption @ working load (1)	13 A	22 A	16 A
Maximum chain speed (2)	20,8 m/min (68,2 ft/min)	20,8 m/min (68,2 ft/min)	21,5 m/min (70,5 ft/min)
Maximum chain speed @ working load (2)	19,3 m/min (63,3 ft/min)	18,1 m/min (59,3 ft/min)	18,3 m/min (60,0 ft/min)
Motor cable size (3)	10 mm ² (AWG7)		
Protection circuit breaker (4)	20 A	30 A	20 A
Deck thickness (5)	20 ÷ 40 mm (3/4" ÷ 1" 9/16 ft)		
Weight	10 kg - 22 lb	10,2 kg - 22,4 lb	10,2 kg - 22,4 lb

(1) After an initial period of use.

(2) Measurements taken with rope 6 mm.

(3) Minimum allowable value for a total length L = < 20m (see connection diagrams). Determine the cable size according to the length of the wiring.

(4) With circuit breaker designed for direct currents (DC) and delayed-action (thermal-magnetic or hydraulic-magnetic).

(5) On request, studs can be supplied for greater deck thicknesses.

DIMENSIONS OF MODELS mm (inch)

PT 350 R - PT 700 R - PT 1000 R

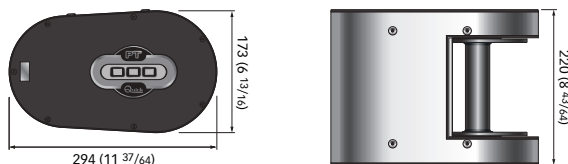

PTR WITH BOW-ROLLER ACCESSORY (ONLY MODELS 350 - 1000)

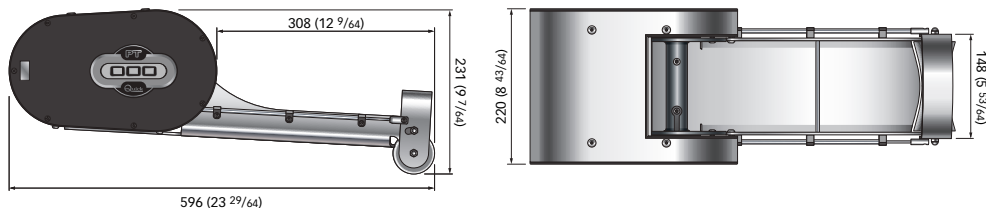

PT 350 G - PT 700 G - PT 1000 G

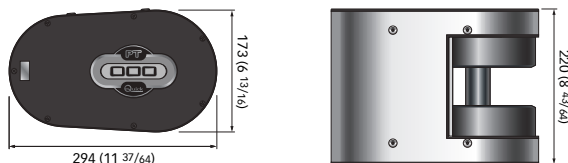

Quick® reserves the right to introduce changes to the equipment and the contents of this manual without prior notice. In case of discordance or errors in translation between the translated version and the original text in the Italian language, reference will be made to the Italian or English text.



**BEFORE USING THE WINDLASS READ THESE INSTRUCTIONS CAREFULLY.
IF IN DOUBT, CONTACT YOUR NEAREST "QUICK®" DEALER.**



WARNING • The Quick® windlasses are designed to weigh the anchor.

- Do not use the equipment for other purposes.
- Quick® shall not be held responsible for damage to equipment and/or personal injury, caused by a faulty use of the equipment. • The windlass is not designed for the loads that might occur in extreme weather conditions (storms).
- Always deactivate the windlass when not in use.
- Check that there are no swimmers nearby before dropping anchor.
- For improved safety we recommend installing at least two anchor windlass controls in case one is accidentally damaged. • We recommend the use of the Quick® hydraulic-magnetic switch as the motor safety switch.
- The reversing contactor unit must be installed in a point protected from accidental water contact.
- After completing the anchorage, secure the rope to fixed points such as chain stopper or bollard.
- To prevent accidental releases, the anchor must be secured. The windlass shall not be used as the only securing device.
- Isolate the windlass from the power system during navigation (switch the circuit breaker off) and lock the rope securing it to a fixed point of the boat.

THE PACKAGE CONTAINS: windlass PTR or PTG - reversing contactor unit (only mod. 700/1000) - 30 m (98 ft) chain Dyneema (only PTR) - drill template - bolts and screws (for assembly) - user's manual - conditions of warranty.

TOOLS REQUIRED FOR INSTALLATION: drill bits: Ø 9 mm (23/64"), Ø 15 mm (63/64"); hexagonal wrench: 13 mm.

"QUICK®"ACCESSORIES RECOMMENDED: anchoring RL control board (mod. 800 - WCS 810) - Waterproof hand holds R/C (mod. HRC1002) - Foot switch (mod. 900) - Strap-roller with spring catch (only PTG) - Hydraulic-magnetic circuit breaker - Radio control RRC (mod. R02, P02, H02).

PTG INSTALLATION REQUIREMENTS

The windlass must be positioned by aligning the flat strap (therefore the windlass' centre) with the hook of the tender to be lifted. Verify that the upper and lower surfaces of the deck are as parallel as possible; in case they are not, compensate the difference appropriately (the lack of parallelism could result in an unsafe installation). The deck thickness must be included among the figures listed in the table. In case of other thicknesses please consult a Quick® dealer.

PTR INSTALLATION REQUIREMENTS

The windlass must be positioned by aligning the reel with the bow roller. If the bow roller has already been installed, ensure that it leans out of the bow (or the stern) so that the descent and ascent of the anchor on the bow roller meets no obstacles. Verify that the upper and lower surfaces of the deck are as parallel as possible; in case they are not, compensate the difference appropriately (the lack of parallelism could result in an unsafe installation). The deck thickness must be included among the figures listed in the table. In case of other thicknesses please consult a Quick® dealer.

INSTALLATION

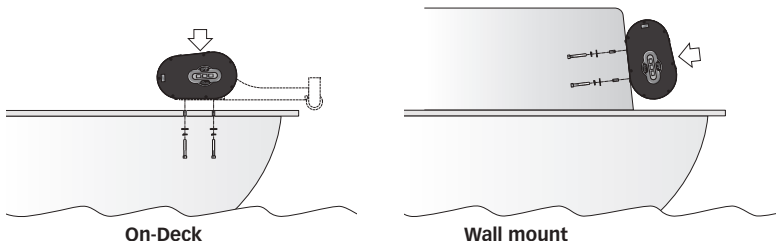

FITTING PROCEDURE

when the ideal position has been established (On-Deck or to the wall) drill holes using the drilling template provided. Remove excess material from the chain passage, refine and flatten with a specialized product (marine paint, gel coat or two pack epoxy). Position the windlass paying attention to the passage of power and control cables. Screw the studs onto the windlass. Connect the supply cables from the windlass to the reversing contactor unit (0 to the battery in case the inverting solenoid unit is integrated).



WARNING: before wiring up, be sure the electrical cables are not live.



**BASIC SYSTEM
WITH RECOMMENDED QUICK® ACCESSORIES
FOR WINDLASS OPERATION**

PT 350 R (version with or without Bow-roller)

PT 350 G

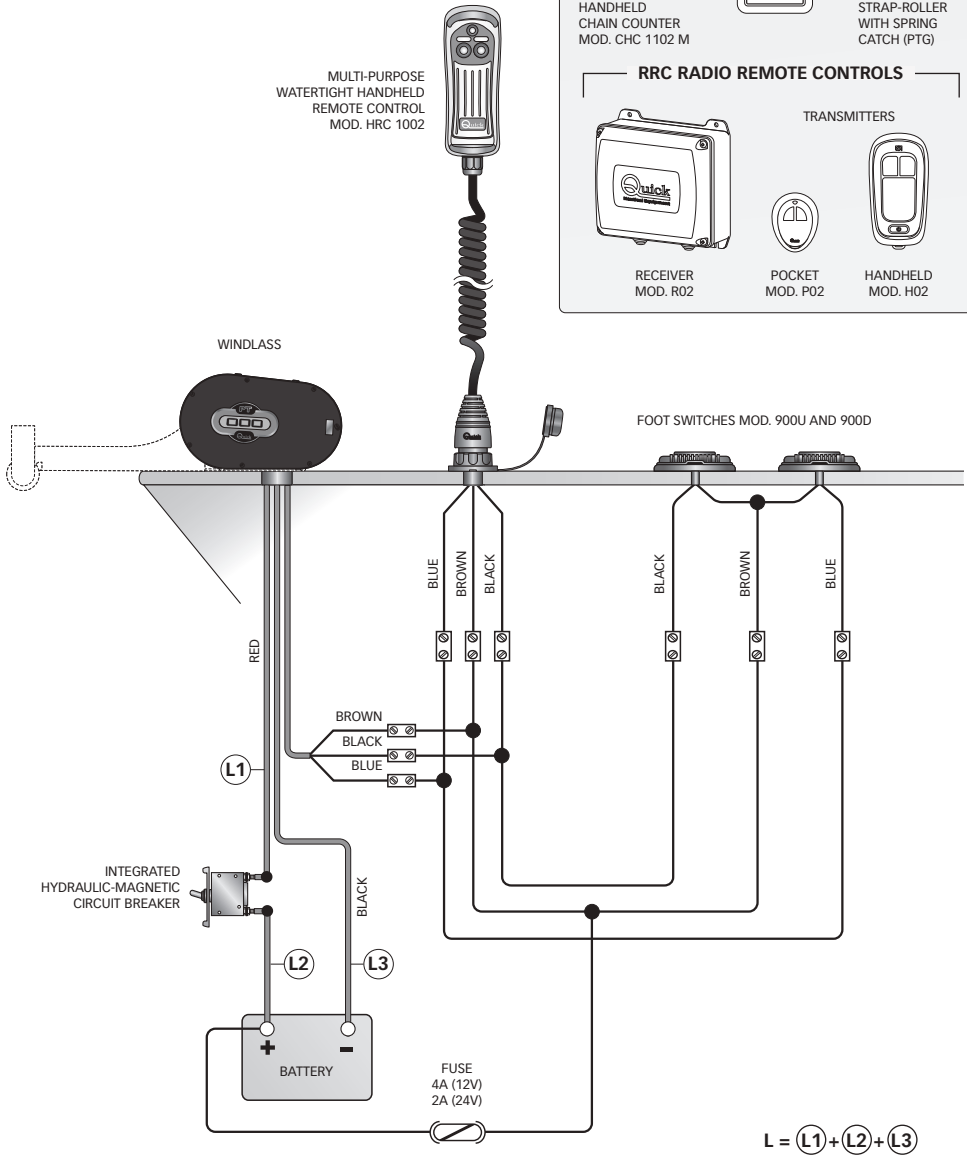
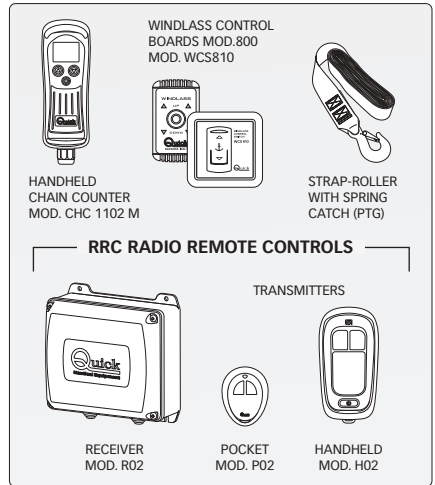

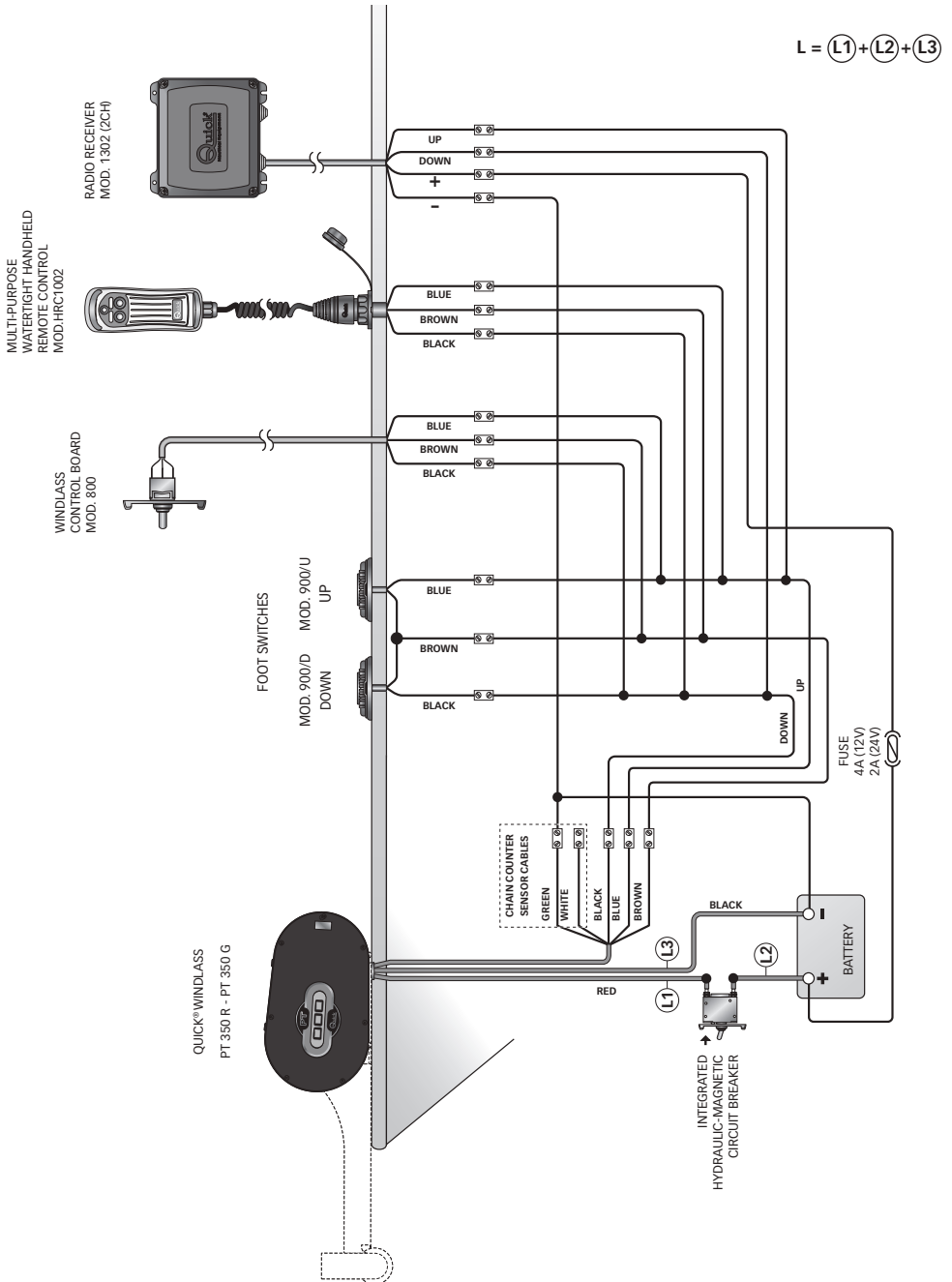



**BASIC SYSTEM
WITH RECOMMENDED QUICK® ACCESSORIES
FOR WINDLASS OPERATION**

PT 700 R - PT 1000 R

PT 700 G - PT 1000 G

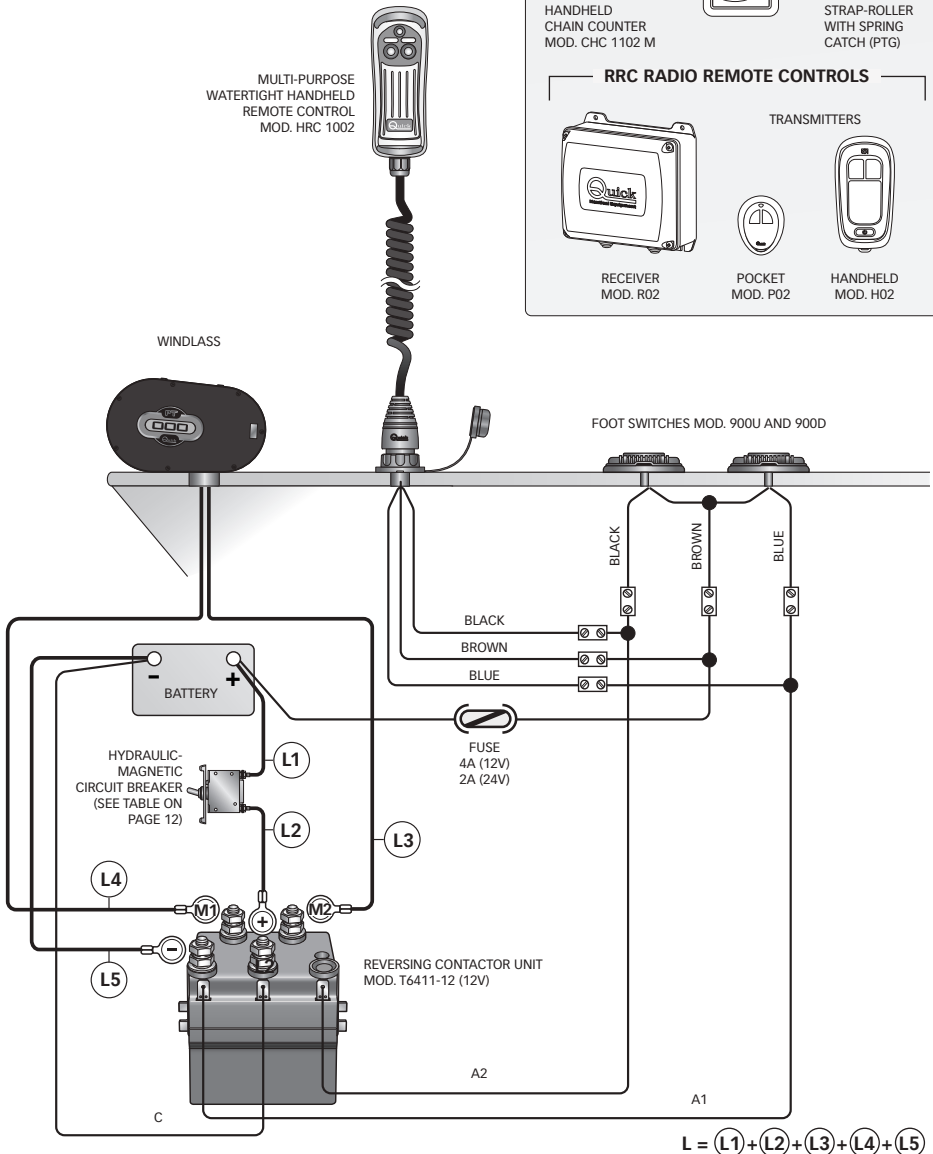
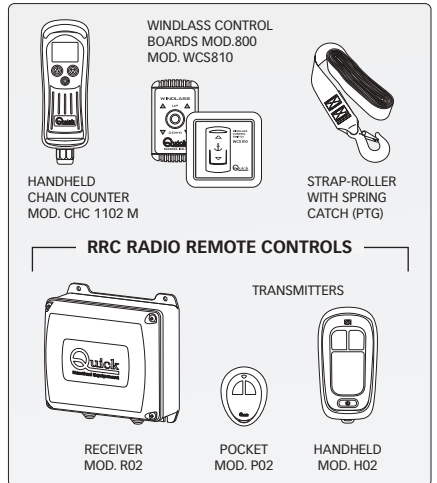



GENERAL CONNECTION DIAGRAM

EN

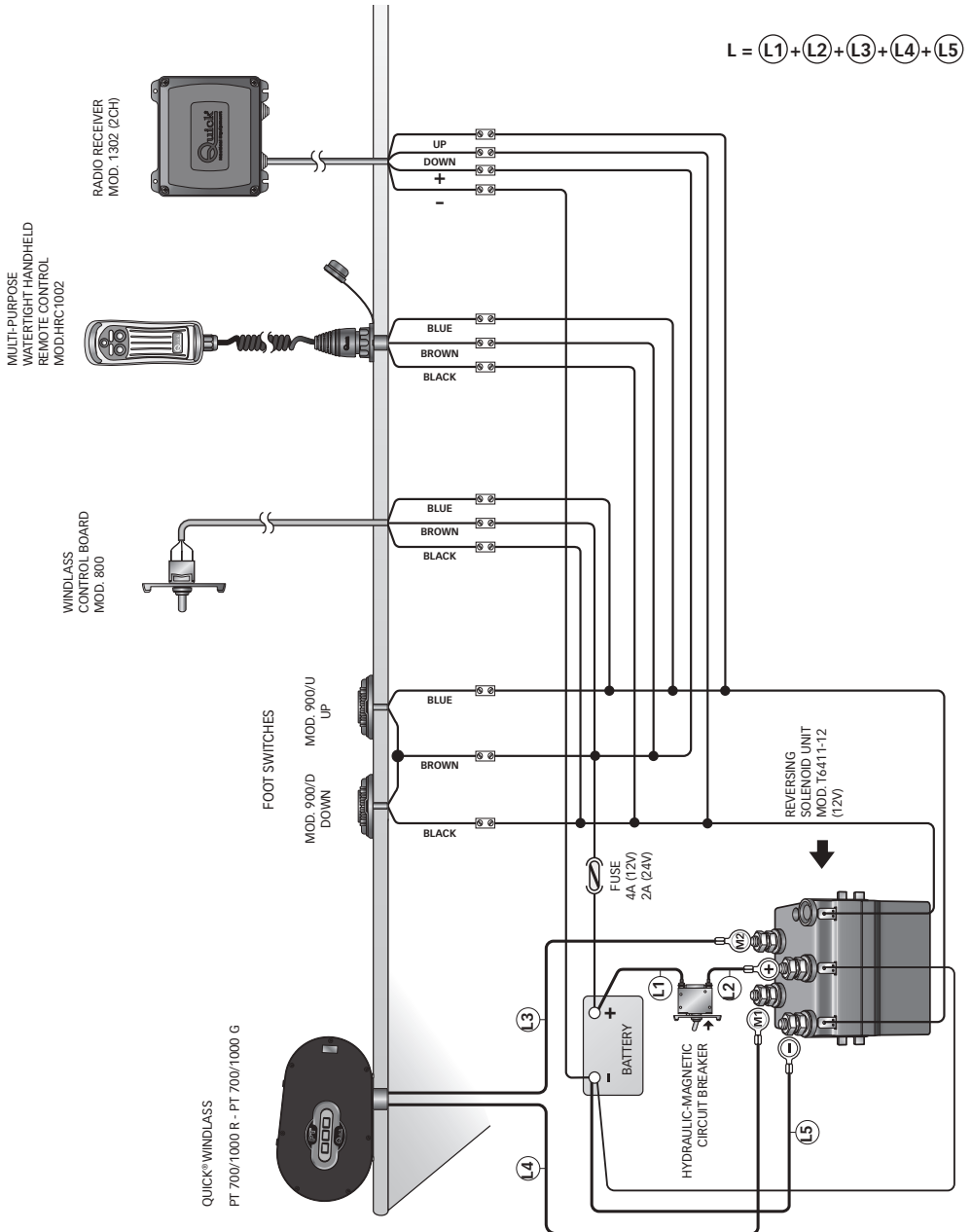



**BASIC SYSTEM
WITH RECOMMENDED QUICK® ACCESSORIES
FOR WINDLASS OPERATION**

PT 700 R with Bow-Roller

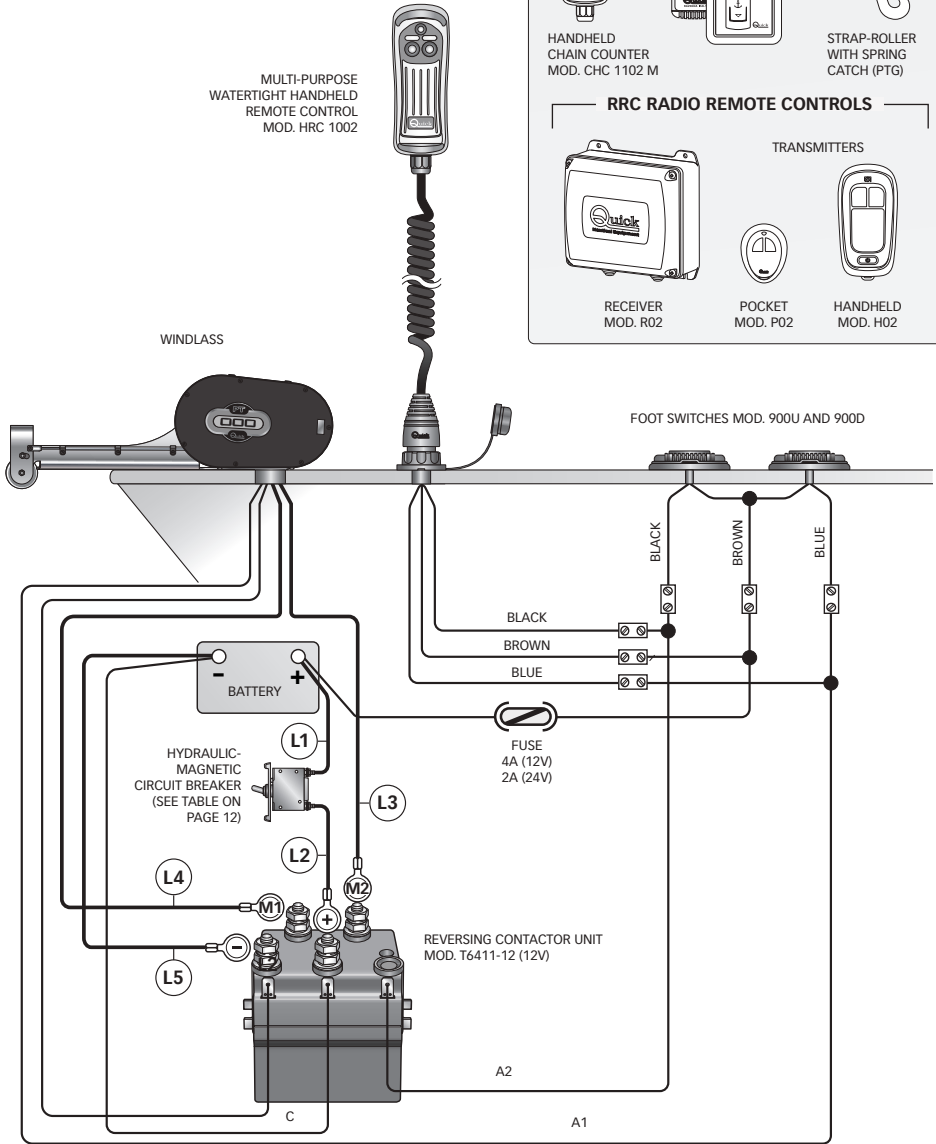
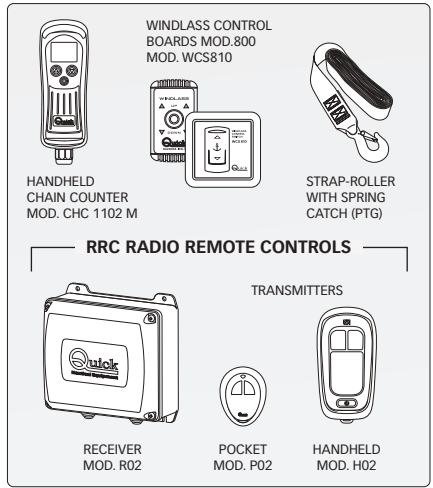

L = (L1) + (L2) + (L3) + (L4) + (L5)



GENERAL CONNECTION DIAGRAM

EN

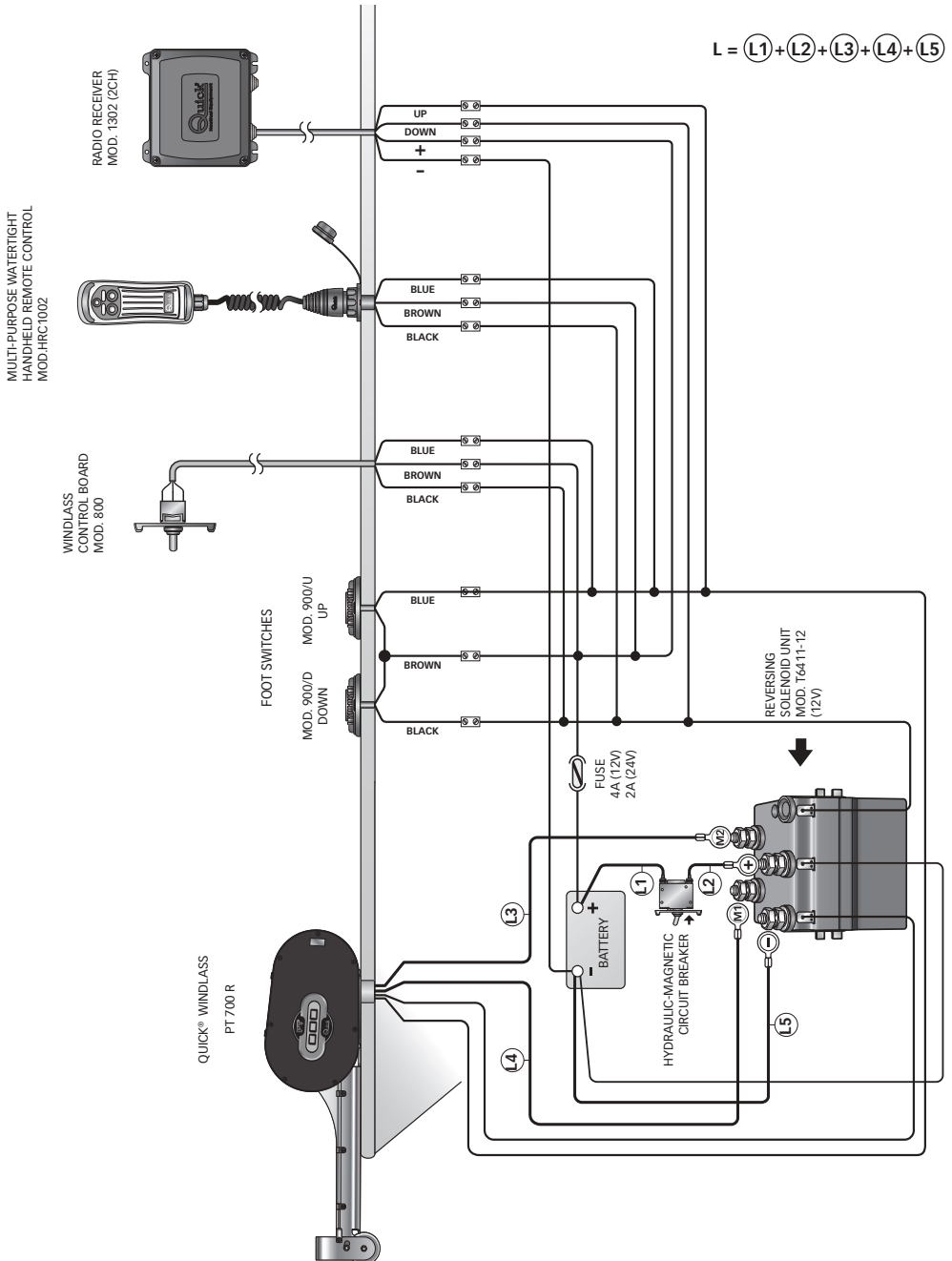

$$L = L1 + L2 + L3 + L4 + L5$$



PONTOON 350 -700-1000

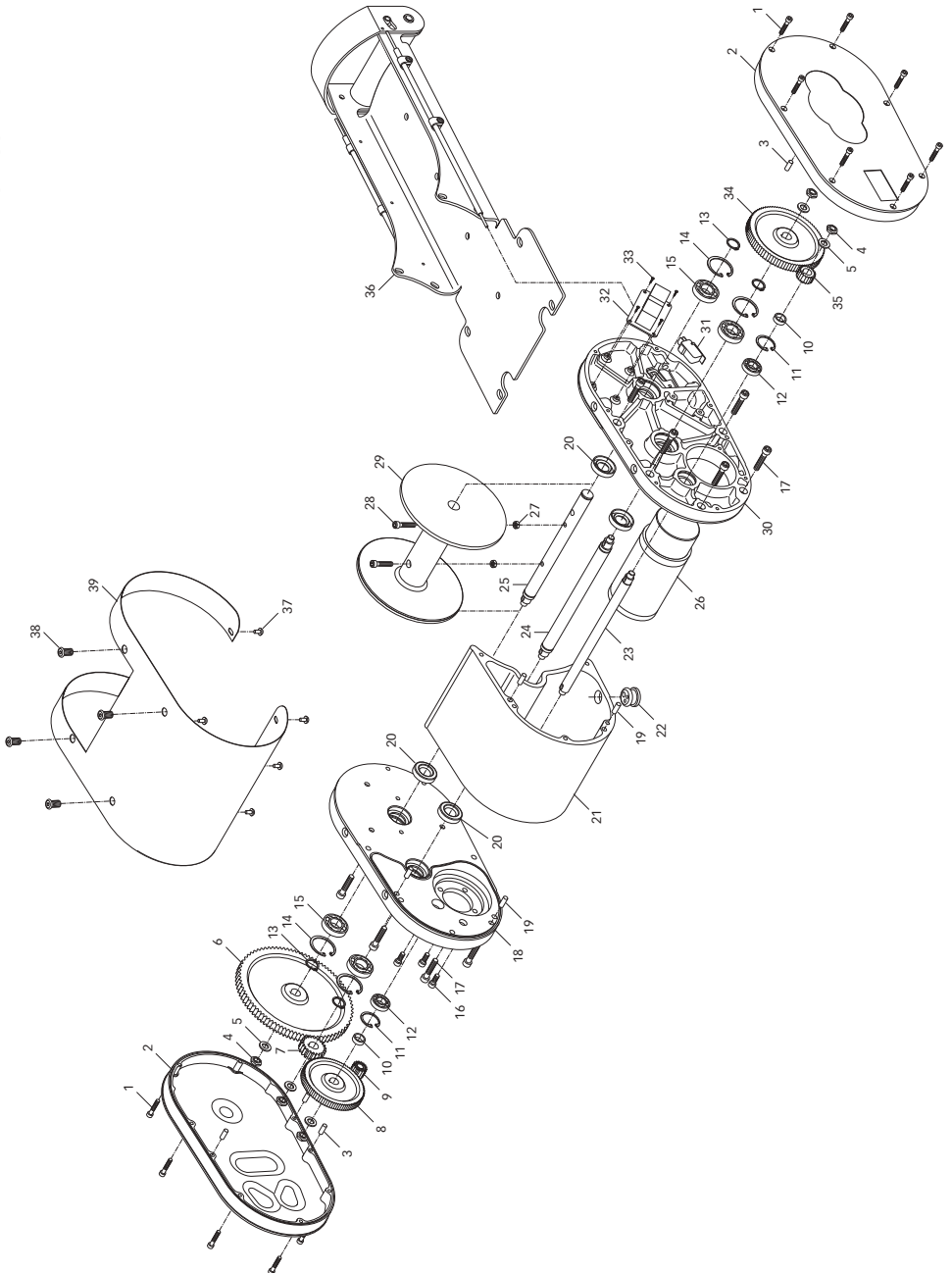

**POS. DESCRIPTION**

- 1 SCREW
- 2 WINDLASS CASING "PT PLAST" SERIES
- 3 PLUG
- 4 NUT
- 5 WASHER
- 6 GEAR Z100 M1.5
- 7 GEAR Z20 M1.5
- 8 GEAR Z80 M1
- 9 GEAR Z16 M1
- 10 PT SPACER
- 11 INTERNAL CIRCLIP
- 12 BEARING
- 13 ESTERNAL CIRCLIP
- 14 INTERNAL CIRCLIP
- 15 BEARING
- 16 SCREW
- 17 SCREW
- 18 WINDLASS BASE PT SERIES
- 19 PLUG L
- 20 OIL SEAL
- 21 WINDLASS EXTRUDED PT SERIES
- 22 CABLE OUTLET PT
- 23 SHAFT PT 1 SERIES
- 24 SHAFT PT 2 SERIES
- 25 SHAFT PT 3 SERIES
- 26A WINDLASS MOTOR 150W 12V PT
- 26B WINDLASS MOTOR 250W 12V PT
- 26C WINDLASS MOTOR 350W 24V PT
- 27 NUT
- 28 SCREW
- 29 WINDLASS REEL "PT PLAST" SERIES
- 30 WINDLASS BASE PT SERIES
- 31 MICROSWITCH BUTTON 16A/250W
- 32 REVERSING CONTACTOR CARD 45A
- 33 SCREW
- 34 GEAR Z100 M1
- 35 GEAR Z20 M1
- 36 COMPLETE BOW ROLLER PT STAINLESS STEEL
- 37 SCREW
- 38 SCREW
- 39 COVER BASE PT SERIES STAINLESS STEEL



WARNING: make sure the electrical power to the motor is switched off when working manually on the windlass. Carefully remove the rope from the reel.

Quick® windlasses are manufactured with materials resistant to marine environments. In any case, any salt deposits on the outside must be removed periodically to avoid corrosion and damage to the equipment.

The parts where salt may have built up should be washed thoroughly with fresh water.



MODELES PONTOON	PT 350 R - PT 350 G	PT 700 R - PT 700 G	PT 1000 R - PT 1000 G
PUISSANCE DU MOTEUR	150 W	250 W	350 W
TENSION D'ALIMENTATION DU MOTEUR	12 V	12 V	24 V
Traction maximum	260 kg (573,2 lb)	600 kg (1322,7 lb)	750 kg (1653,4 lb)
Charge de travail maximale	100 kg (220,4 lb)	220 kg (485,0 lb)	250 kg (551,0 lb)
Charge de travail	40 kg (88,1 lb)	80 kg (176,3 lb)	100 kg (220,4 lb)
Absorption de courant à la charge de travail (1)	13 A	22 A	16 A
Vitesse maximale de récupération (2)	20,8 m/min (68,2 ft/min)	20,8 m/min (68,2 ft/min)	21,5 m/min (70,5 ft/min)
Vitesse de récupération à la charge de travail (2)	19,3 m/min (63,3 ft/min)	18,1 m/min (59,3 ft/min)	18,3 m/min (60,0 ft/min)
Section minimale du câble du moteur (3)	10 mm ² (AWG7)		
Disjoncteur (4)	20 A	30 A	20 A
Epaisseur du pont (5)	20 ÷ 40 mm (3/4" ÷ 1" 9/16 ft)		
Poid	10 kg - 22 lb	10,2 kg - 22,4 lb	10,2 kg - 22,4 lb

- (1) A l'arrêt, après utilisation.
 (2) Mesures effectuées avec cordage de 6 mm.
 (3) Valeur minimale conseillée pour une longueur totale L<20m (voir schémas de câblage). Déterminer la grandeur du câble requise selon la longueur de la connexion.
 (4) Avec des disjoncteurs conçus pour courants continus (DC) et retardés (magnétique-thermique ou magnétique-hydraulique).
 (5) Il peut être fourni, sur demande, des prisonniers pour des ponts d'épaisseur plus élevée.

DIMENSIONS DES MODELES mm (inch)

PT 350 R - PT 700 R - PT 1000 R

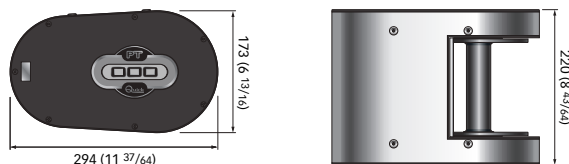

PTR AVEC ACCESSOIRE BOW-ROLLER (SEULEMENT MODELES 350 - 1000)

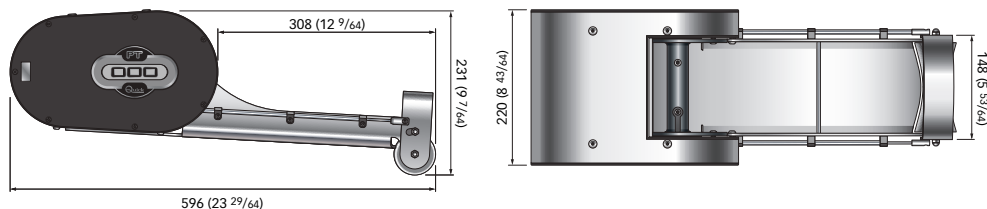

PT 350 G - PT 700 G - PT 1000 G

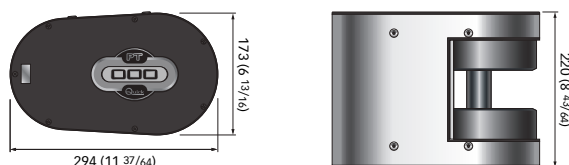

La société Quick® se réserve le droit d'apporter les modifications nécessaires aux caractéristiques techniques de l'appareil et au contenu de ce livret sans avis préalable. En cas de discordances ou d'erreurs éventuelles entre la traduction et le texte original en italien, se référer au texte italien ou anglais.



**AVANT D'UTILISER LE GUINDEAU, LIRE ATTENTIVEMENT CE LIVRET D'INSTRUCTIONS.
EN CAS DE DOUTES, S'ADRESSER AU REVENDEUR QUICK®.**



ATTENTION • Les guindeaux Quick® ont été conçus et construits pour lever l'ancre.

• Ne pas utiliser ces appareils pour effectuer d'autres types d'opérations. • Quick® n'assume aucune responsabilité pour les dommages directs ou indirects causés par un mauvais usage de l'appareil.
• Le guindeau n'a pas été prévu pour soutenir les charges provoquées lors de conditions atmosphériques particulières (tempête). • Toujours désactiver le guindeau quand il n'est pas utilisé. • Avant de jeter l'ancre, vérifier qu'il n'y a pas de baigneur à proximité. • Pour une plus grande sécurité, nous suggérons d'installer au moins deux commandes pour actionner le guindeau au cas où une de celle-ci s'abîmerait • Nous conseillons l'utilisation de l'interrupteur magnétique-hydraulique Quick® comme sécurité pour le moteur. • La boîte relai inverseurs doit être installée dans un endroit protégé des éventuelles entrées d'eau. • Après avoir complété l'ancrage, fixer le cordage à des points fixes comme le bloqueur de chaîne ou la bitte. • Afin de prévenir des relâches accidentels, l'ancre doit être fixée; le guindeau ne doit pas être utilisé comme seule prise de force. • Isoler le guindeau du système électrique pendant la navigation (débrancher le disjoncteur magnétique) et bloquer le cordage à un point fixe du bateau.

L'EMBALLAGE COMPREND: guindeau PTG ou PTR - boîtier relai inverseurs (seulement mod. 700/1000) - 30 m de cordage Dyneema (seulement PTR) - gabarit de perçage - différentes vis (pour l'assemblage) - livret d'instructions - conditions de garantie.

ATTREZZI NECESSARI PER L'INSTALLAZIONE: trapano con punte: Ø 9 mm (23/64"), Ø 15 mm (63/64"); chiave esagonale: 13 mm.

ACCESSOIRES QUICK® RECOMMANDES: interrupteur sur panneau (mod. 800 - WCS 810) - Télécommande étanche (mod. HRC1002) - Bouton à pied (mod. 900) - Bande avec mousqueton (solo PTG) - Système de commande par radio RRC (mod. R02, P02, H02).

CONDITIONS REQUISES POUR L'INSTALLATION - PTG

Le guindeau doit être positionné en alignant la corde (donc le centre du guindeau) avec le crochet du tender à soulever. Contrôler que les surfaces supérieures et inférieures du pont soient les plus parallèles possibles, si ce n'est pas le cas, compenser la différence de manière opportune (le manque de parallélisme pourrait provoquer des pertes de puissance du moteur). L'épaisseur du pont devra être comprise parmi les valeurs indiquées dans le tableau. En cas d'épaisseurs différentes, s'adresser au revendeur Quick®.

CONDITIONS REQUISES POUR L'INSTALLATION - PTR

Le guindeau doit être positionné en alignant la bobine avec le bow roller. Si le bow roller est déjà monté, s'assurer qu'il sorte de la proue (ou de la poupe) afin que la descente et la remontée de l'ancre dans le bow roller ne rencontre pas d'obstacles. Contrôler que les surfaces supérieures et inférieures du pont soient les plus parallèles possibles, si ce n'est pas le cas, compenser la différence de manière opportune (le manque de parallélisme pourrait provoquer des pertes de puissance du moteur). L'épaisseur du pont devra être comprise parmi les valeurs indiquées dans le tableau. En cas d'épaisseurs différentes, s'adresser au revendeur Quick®.

INSTALLATION

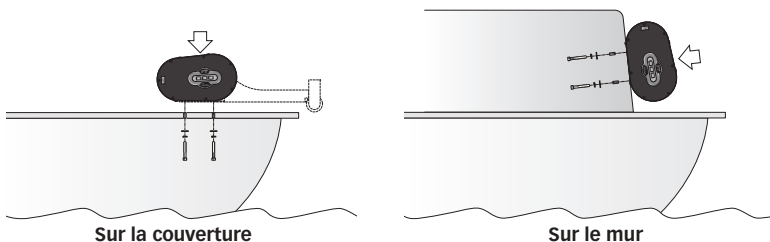

METHODE DE MONTAGE

une fois que la position idéale est établie (sur la couverture, sous la couverture ou sur le mur) faire les trous en utilisant le gabarit de perçage fourni avec l'appareil. Enlevez le matériel en excès de l'écubier de puits à chaînes, fignez et lissez l'écubier avec un produit spécifique (peinture marine, enduit gélicifé or résine epoxy). Posizionare il salpa ancora facendo attenzione al passaggio dei cavi di potenza e di comando. Serrer les goujons au guindeau. Fixer le guindeau avec les écrous sur les goujons de fixation. Brancher les câbles d'alimentation provenant du guindeau au relais inverseurs ((ou à la batterie si le téléinverseur est intégré).



ATTENTION: avant d'effectuer la connexion, contrôler que les câbles ne soient pas alimentés électriquement.



**STSTEME DE BASE
AVEC ACCESSOIRES QUICK® RECOMMANDES
POUR ACTIONNER LE GUINDEAU**

PT 350 R (version avec ou sans Bow-roller)

PT 350 G

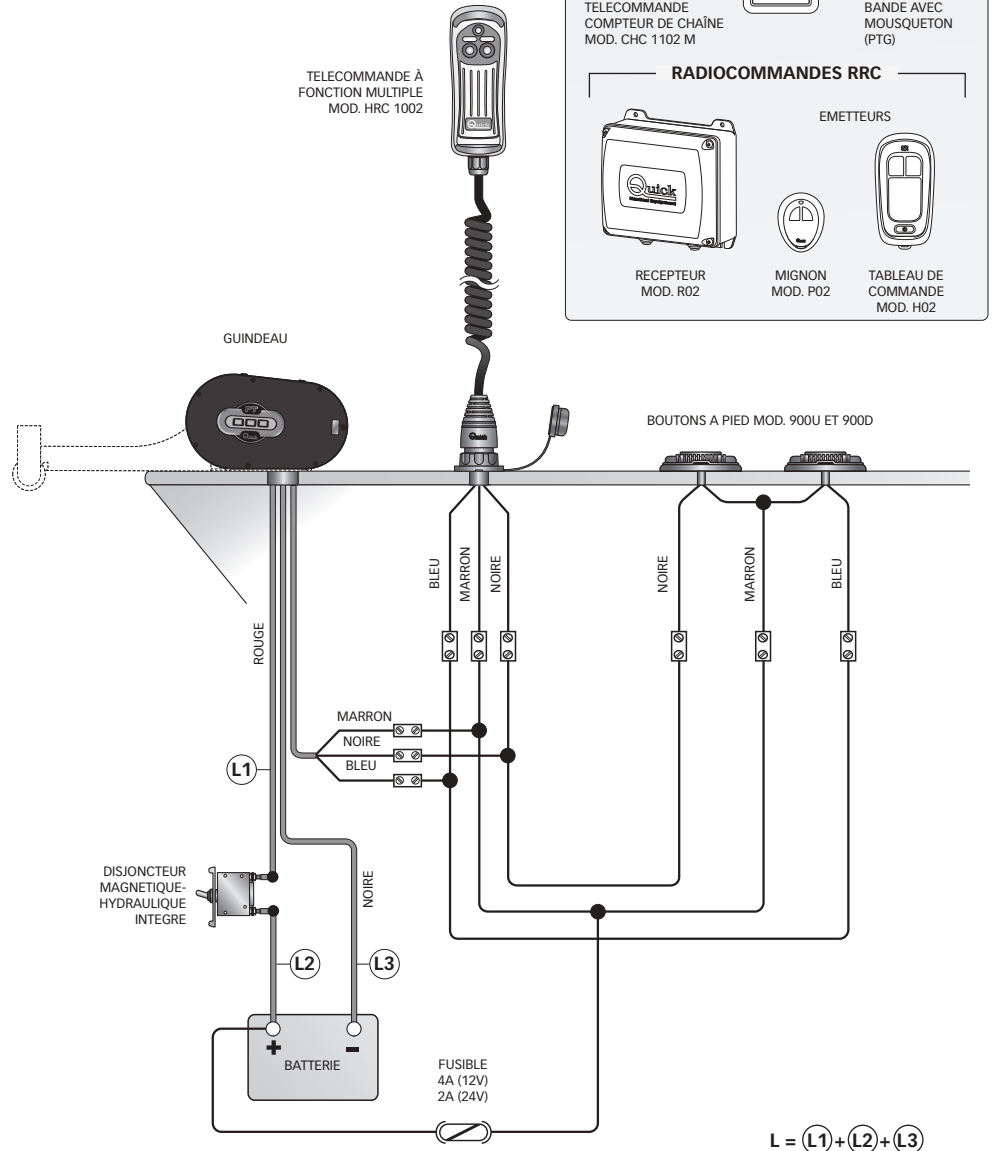

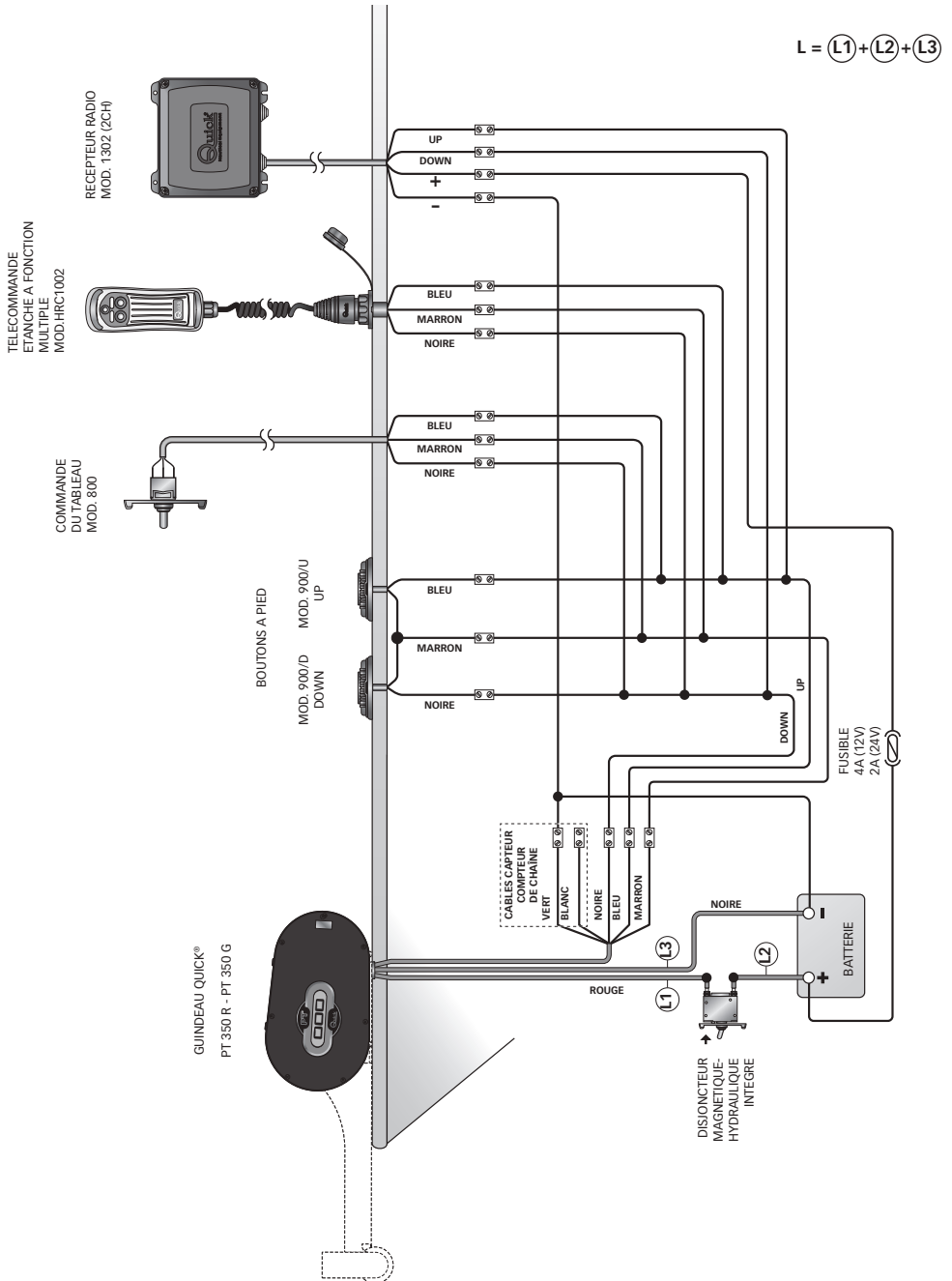



**STSTEME DE BASE
AVEC ACCESSORIES QUICK® RECOMMANDES
POUR ACTIONNER LE GUINDEAU**

PT 700 R - PT 1000 R
PT 700 G - PT 1000 G

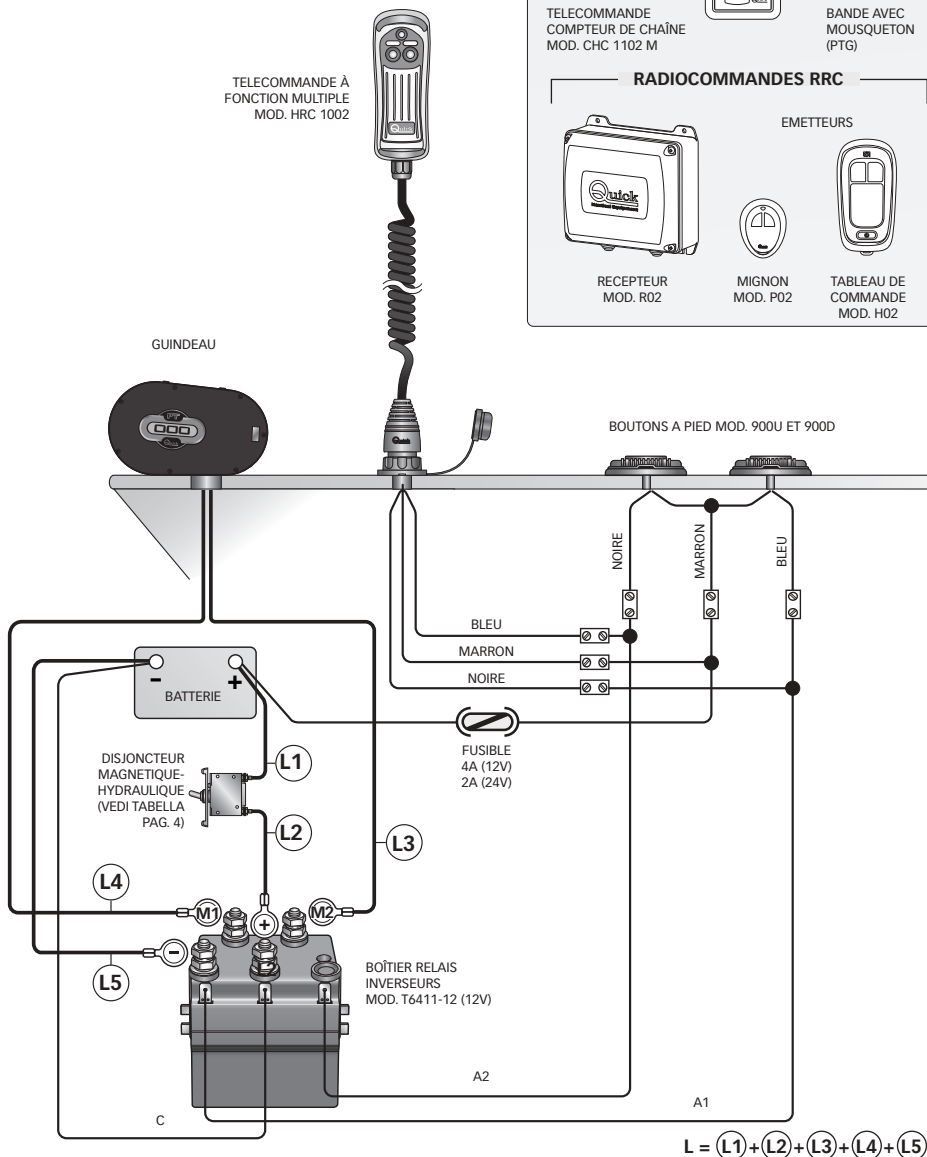
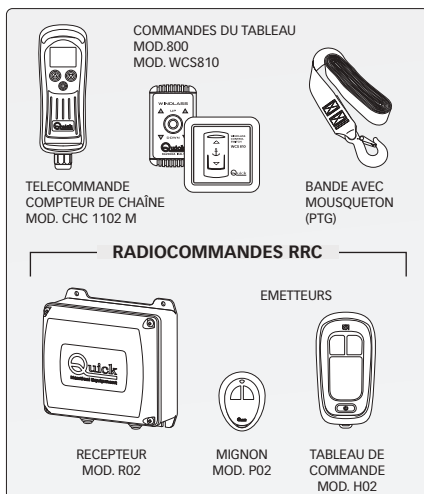

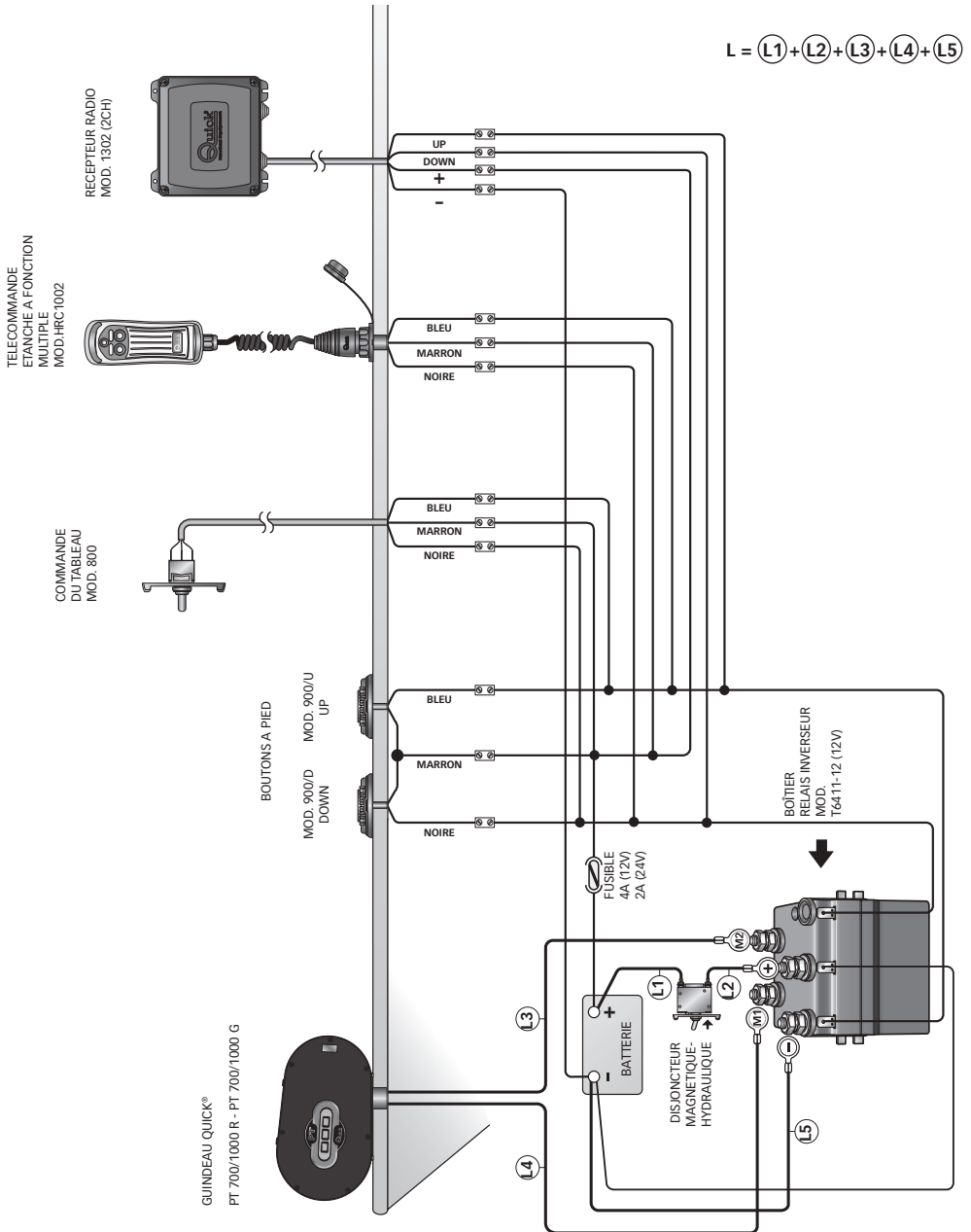



**STSTEME DE BASE
AVEC ACCESSOIRES QUICK® RECOMMANDES
POUR ACTIONNER LE GUINDEAU**

PT 700 R avec Bow-Roller

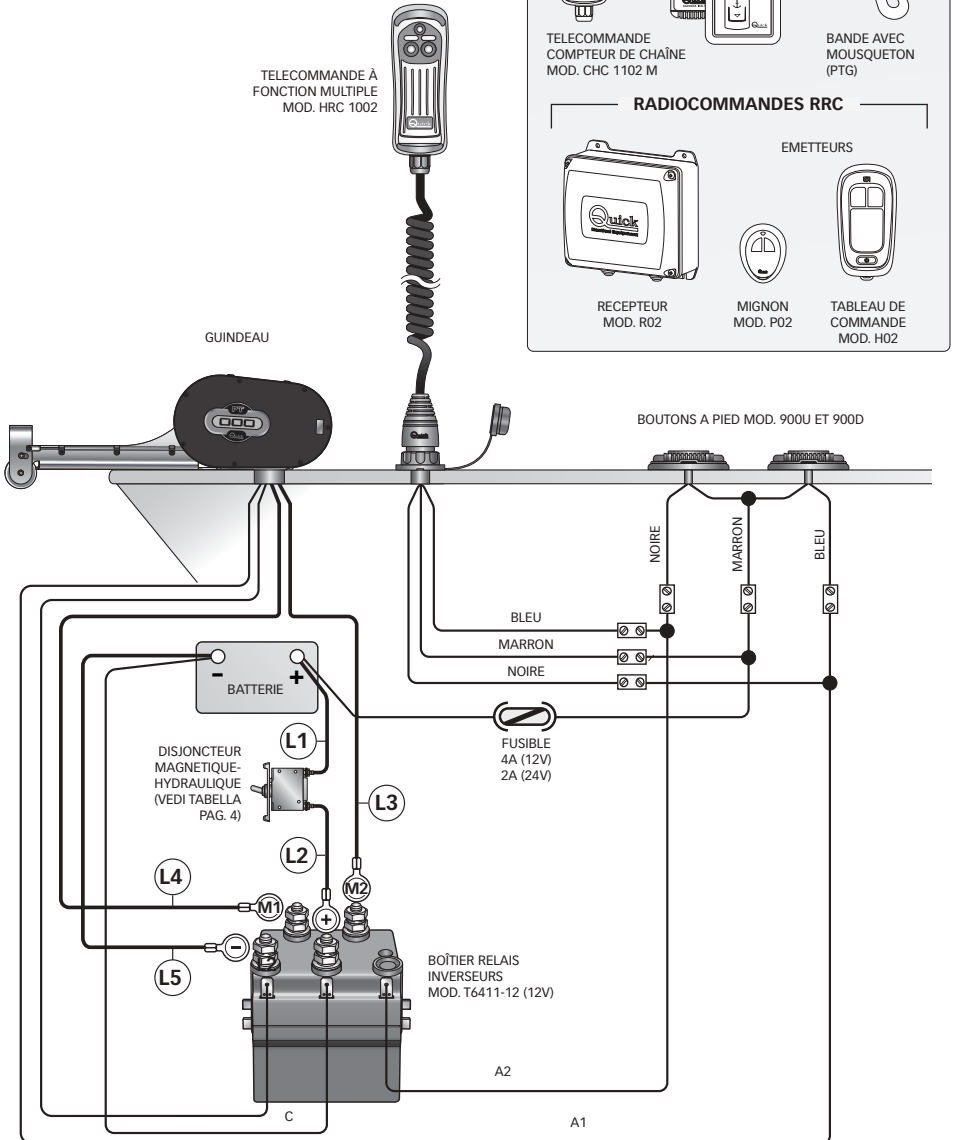

$$L = (L1) + (L2) + (L3) + (L4) + (L5)$$

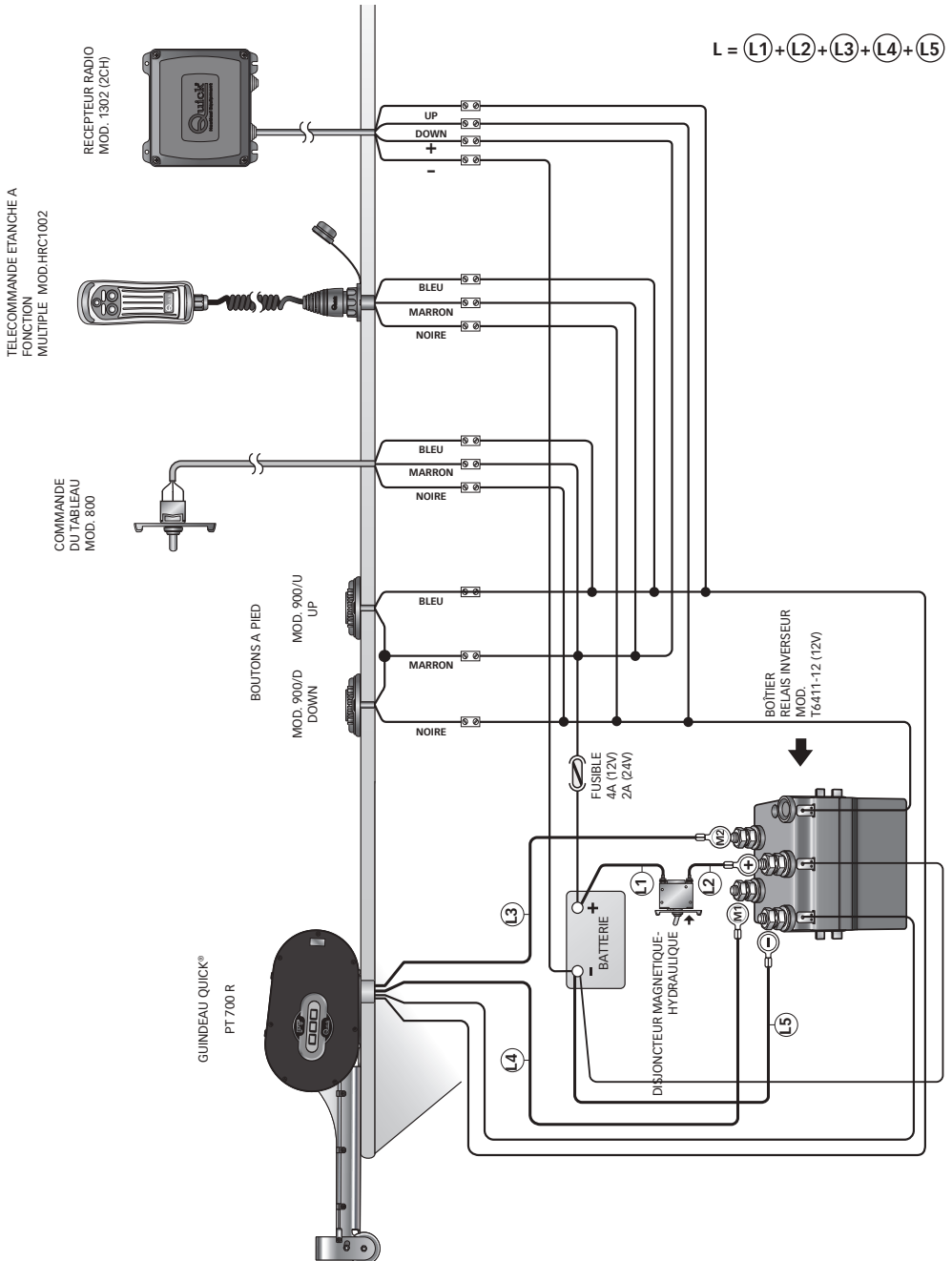



PONTOON 350 -700-1000

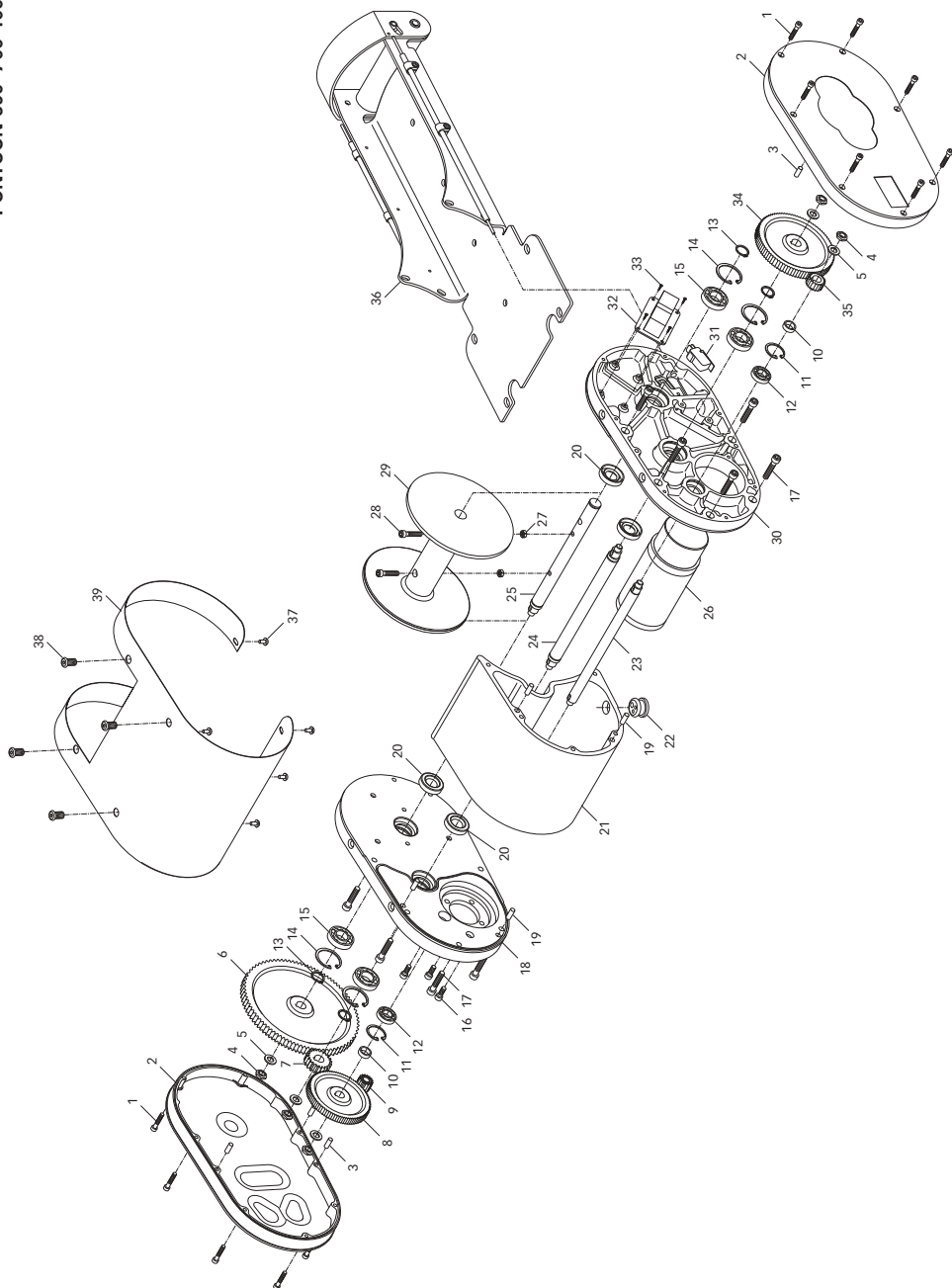



POS.	DENOMINATION
1	VIS
2	CARTER GUINDEAU SÉRIE "PT PLAST"
3	FICHE
4	ÉCROUS
5	RONDELLE
6	ROUE Z100 M1.5
7	ROUE Z20 M1.5
8	ROUE Z80 M1
9	ROUE Z16 M1
10	ENTRETOISE PT
11	CIRCLIP INTERNE
12	ROULEMENT
13	CIRCLIP EXTERNE
14	CIRCLIP INTERNE
15	ROULEMENT
16	VIS
17	VIS
18	BASE GUINDEAU SÉRIE PT
19	FICHE
20	JOINT ÉTANCHE À L'HUILE
21	EXTRUDÉ GUINDEAU SÉRIE PT
22	PASSA-CABLE PT
23	ARBRE SERIE PT 1
24	ARBRE SERIE PT 2
25	ARBRE SERIE PT 3
26A	MOTEUR GUINDEAU 150W 12V PT
26B	MOTEUR GUINDEAU 250W 12V PT
26C	MOTEUR GUINDEAU 350W 24V PT
27	ÉCROUS
28	VIS
29	BOBINE GUINDEAU SÉRIE "PT PLAST"
30	BASE GUINDEAU SÉRIE PT
31	POUSSOIR DU MICROSWITCH 16A/250W
32	CARTE RELAIS INVERSEUR 45A
33	VIS
34	ROUE Z100 M1
35	ROUE Z20 M1
36	BOW ROLLER PT COMPLETE INOX
37	VIS
38	VIS
39	COVER BASE SÉRIE PT INOX

 **ATTENTION:** contrôler que le moteur ne soit pas alimenté électriquement lorsqu'on agit sur le guindeau manuellement. Retirez délicatement le cordage de la bobine.

Les guindeaux Quick® sont construits avec des matériaux qui résistent bien à l'habitat marin: de toute façon, il est indispensable d'enlever périodiquement les dépôts de sel se formant sur les surfaces externes pour éviter tout effet de corrosion et des dommages à l'appareil.

Laver les surfaces et les pièces où le sel peut se déposer avec de l'eau douce.



MODELLE PONTOON	PT 350 R - PT 350 G	PT 700 R - PT 700 G	PT 1000 R - PT 1000 G
MOTORLEISTUNG	150 W	250 W	350 W
SPANNUNG MOTOR	12 V	12 V	24 V
Maximale Zug	260 kg (573,2 lb)	600 kg (1322,7 lb)	750 kg (1653,4 lb)
Maximale Arbeitslast	100 kg (220,4 lb)	220 kg (485,0 lb)	250 kg (551,0 lb)
Arbeitslast	40 kg (88,1 lb)	80 kg (176,3 lb)	100 kg (220,4 lb)
Stromaufnahme bei Arbeitslast (1)	13 A	22 A	16 A
Maximale Rückholgeschwindigkeit (2)	20,8 m/min (68,2 ft/min)	20,8 m/min (68,2 ft/min)	21,5 m/min (70,5 ft/min)
Rückholgeschwindigkeit bei Arbeitslast (2)	19,3 m/min (63,3 ft/min)	18,1 m/min (59,3 ft/min)	18,3 m/min (60,0 ft/min)
Motorkabel-Mindestquerschnitt (3)	10 mm ² (AWG7)		
Schutzschalter (4)	20 A	30 A	20 A
Stärke des Decks (5)	20 ÷ 40 mm (3/4" ÷ 1" 9/16 ft)		
Gewicht	10 kg - 22 lb	10,2 kg - 22,4 lb	10,2 kg - 22,4 lb

(1) Bei gekuppeltem Motor nach der Anlaufphase.

(2) Durchgeführte Messungen mit für 6 mm-Tau.

(3) Empfohlener Mindestwert für eine gesamtmenge lange L<20m (Siehe Anschlussplannen). Den Kabelquerschnitt in Abhängigkeit zur Länge des Anschlusses berechnen.

(4) Mit besonderem Schalter für Gleichstrom (DC) und Verzögerung (Überstrom Schutzautomat oder Hydraulischer Schutzautomat).

(5) Auf Anfrage können Gewindestifte für stärker Decks geliefert werden.

ABMESSUNGEN DER MODELLE mm (inch)

PT 350 R - PT 700 R - PT 1000 R

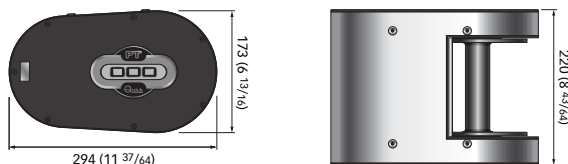

PTR MIT ZUBEHÖR BOW-ROLLER (NUR MODELLE 350 - 1000)

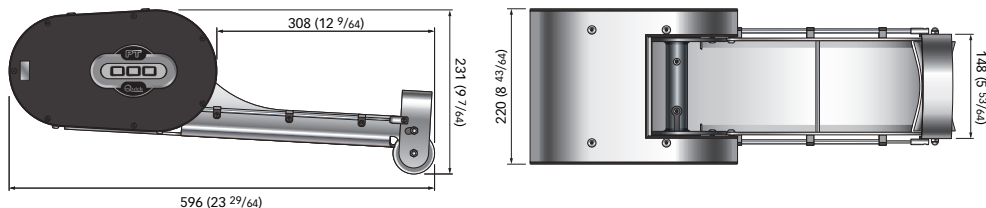

PT 350 G - PT 700 G - PT 1000 G

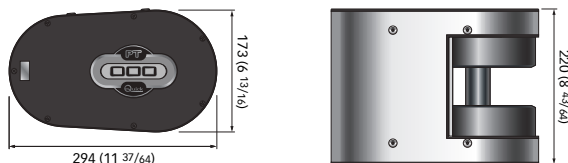

Quick® behält sich das Recht auf Änderungen der technischen Eigenschaften des Geräts und des Inhalts dieses Handbuchs ohne Vorankündigung vor. Bei Fehlern oder eventuellen Unstimmigkeiten zwischen der Übersetzung und dem Ausgangstext ist der Ausgangstext in Italienisch oder Englisch maßgeblich.



VOR DEM GEBRAUCH DER ANKERWINDE DIESE BETRIEBSANLEITUNG AUFMERKSAM DURCHLESEN. IM ZWEIFELSFALL WENDEN SIE SICH BITTE AN DEN QUICK®-VERTRAGSHÄNDLER.



ACHTUNG • Die Quick®-Ankerwinden wurden eigens für das Fieren der Anker entwickelt und hergestellt.

- Diese Vorrichtungen für keine anderen Zwecke verwenden. • Quick® haftet nicht für direkte oder indirekte Schäden, die durch einen unsachgemäßen Gebrauch des Geräts entstehen. • Die Ankerwinde ist nicht darauf ausgelegt, Belastungen unter besonderen Wetterbedingungen (Sturm) standzuhalten. • Die Ankerwinde immer ausschalten, wenn sie nicht benützt wird. • Vor dem Herunterlassen vom Anker muss sicher-gestellt werden, dass sich keine Badenden in der Nähe aufhalten.
- Um für mehr Sicherheit zu garantieren, sollten mindestens zwei Steuerungen für die Ankerwinde instal-liert werden für den Fall, dass Defekte an einer der Steuerungen auftreten. • Es wird zur Verwendung eines Hauptsi-cherungsautomaten Quick® zur Motorsicherung geraten. • Die Dose mit den Umpolrelaisbox muss an einem vor Wasser geschützten Ort installiert werden. • Nachdem Sie geankert haben, Kette/Seil immer über Kettenstopper bzw. Poller fest halten.
- Um einer ungewollten Freisetzung vorzubeugen muss der Anker gesichert werden; der Ankerwinde darf noch nicht als einzige Zapfwelle verwendet werden. • Die Ankerwinde während der Navigation vom Elektromotor abtrennen (den Motor-schutzschalter ausschalten) und die Kette an einem festen Punkt des Boots blockieren.

DIE PACKUNG ENTHÄLT: Ankerwinde PTG oder PTR - Umpolrelaisbox (nur Mod. 700/1000) - 30 m Kette Dyneema (nur PTR) - Bohrschablone - Schrauben (für den zusammenbau) - Betriebsanleitung - Garantiebedingungen.

NOTWENDIGE WERKZEUGE FÜR DIE INSTALLATION: Bohrmaschine Bohrer: Ø 9 mm (23/64"), Ø 15 mm (63/64"); Inbusschlüssel: 13 mm.

EMPFOHLENE QUICK®-ZUBEHÖRTEILE: Schalter an Bedientafel (Mod. 800 - WCS 810) - Wasserdichte Fernbedienung (Mod. HRC1002) - Fußschalter (Mod. 900) - Gurtband mit karabinahaken (nur PTG) - Funksteuersystem RRC (Mod. R02, P02, H02).

VORAUSSETZUNGEN FÜR DIE INSTALLATION - PTG

Die Ankerwinde wird positioniert, indem das Band (d.h. das Zentrum der Ankerwinde) mit dem Haken des zu hebenden Tenders ausgerichtet wird. Sicherstellen, dass Oberseite und Unterseite vom Deck so parallel wie möglich verlaufen; Falls nicht, die Differenz auf geeignete Weise ausgleichen, da es sonst zu Leistungsverlust am Motor kommen kann. Die Dicke vom Deck muss innerhalb der in der Tabelle angegebenen Wertspannen liegen. Sollte die Dicke nicht mit den angegebenen Werten übereinstimmen, muss mit dem Quick®.

VORAUSSETZUNGEN FÜR DIE INSTALLATION - PTR

Die Ankerwinde wird positioniert, indem man die Spule mit dem Bow-Roller ausrichtet. Wenn der Bow-Roller bereits montiert ist, sicherstellen, dass er am Bug (oder am Heck) herausragt, damit das Aus- und Einfahren des Ankers am Bow-Roller nicht auf Hindernisse trifft. Sicherstellen, dass Oberseite und Unterseite vom Deck so parallel wie möglich verlaufen; Falls nicht, die Differenz auf geeignete Weise ausgleichen, da es sonst zu Leistungsverlust am Motor kommen kann. Die Dicke vom Deck muss innerhalb der in der Tabelle angegebenen Wertspannen liegen. Sollte die Dicke nicht mit den angegebenen Werten übereinstimmen, muss mit dem Quick®.

INSTALLATION

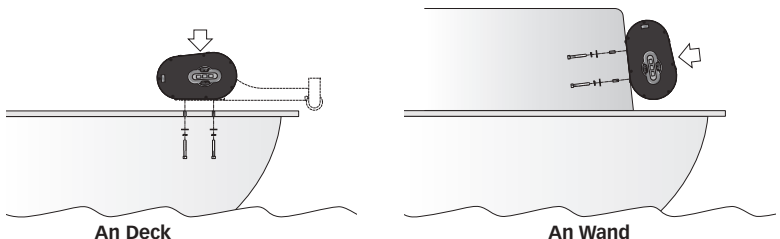

MONTAGEPROZEDUR

Nachdem die ideale Position festgesetzt wurde (an Deck, an Wand), realisiert man mithilfe der mitgelieferten Bohrschablone die Bohrungen. Das überschüssige Material an den Bohrungen entfernen, dann mit einem Spezialprodukt (Bootsfarbe, Gel oder Epoxidharz) feinarbeiten und glätten. Die Ankerwinde positionieren und dabei auf den Durchgang der Leistungskabel und Steuerleitungen achten. Die Stiftschrauben an der Ankerwinde anschrauben. Die Ankerwinde befestigen, indem man die Muttern an den Blockierungsstiftschrauben befestigt. Die von der Ankerwinde kommenden Versorgungskabel am Fernumschalter anschließen (oder falls der Umpolrelais integriert ist, an der Batterie).



ACHTUNG: vor Durchführung des Anschlusses sicherstellen, daß an den Kabeln keine Spannung anliegt.



**BASISSYSTEM
MIT EMPFOHLENE QUICK®-ZUBEHÖRTEILE
FÜR DIE BETÄTIGUNG DER ANKERWINDE**

PT 350 R (mit oder ohne Bow-roller)

PT 350 G

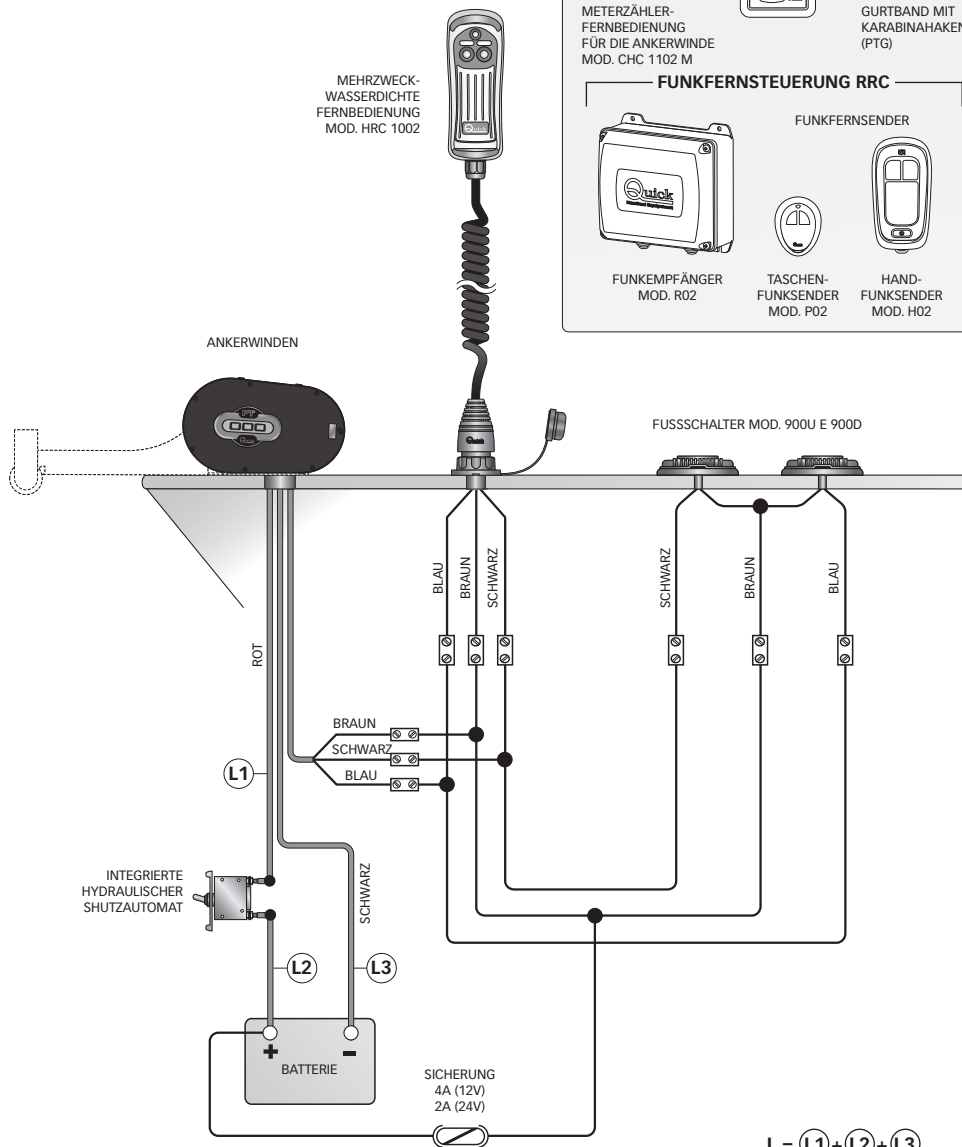
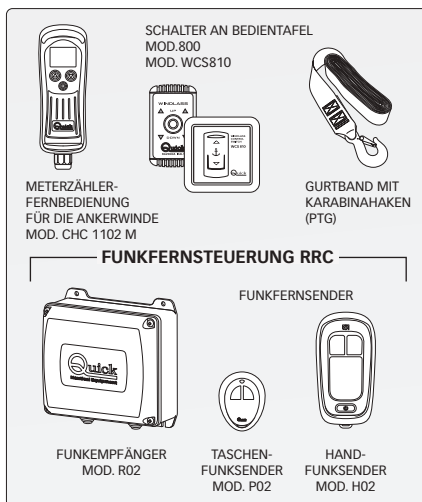

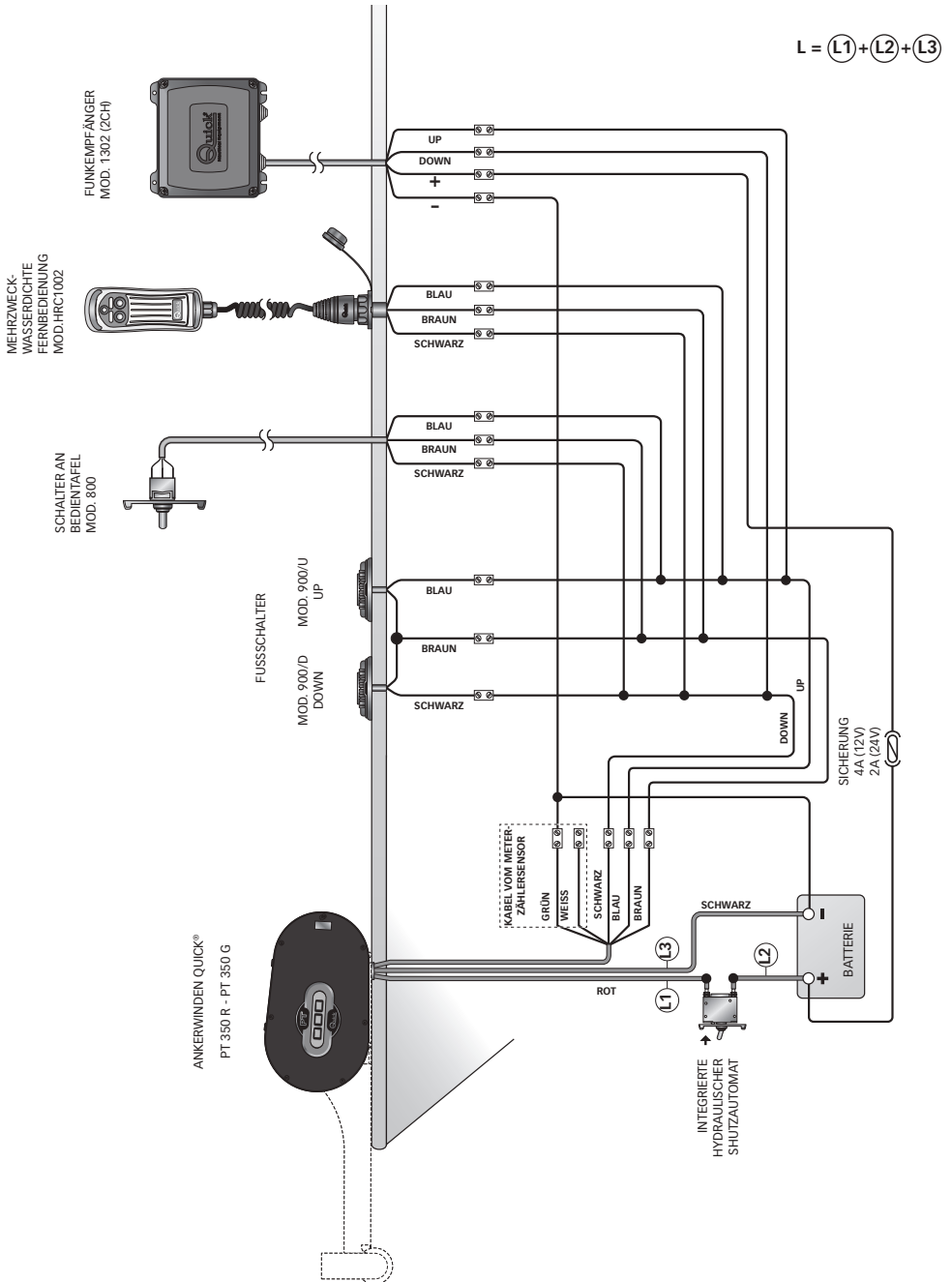



**BASISSYSTEM
MIT EMPFOHLENE QUICK®-ZUBEHÖRTEILE
FÜR DIE BETÄTIGUNG DER ANKERWINDE**

PT 700 R - PT 1000 R

PT 700 G - PT 1000 G

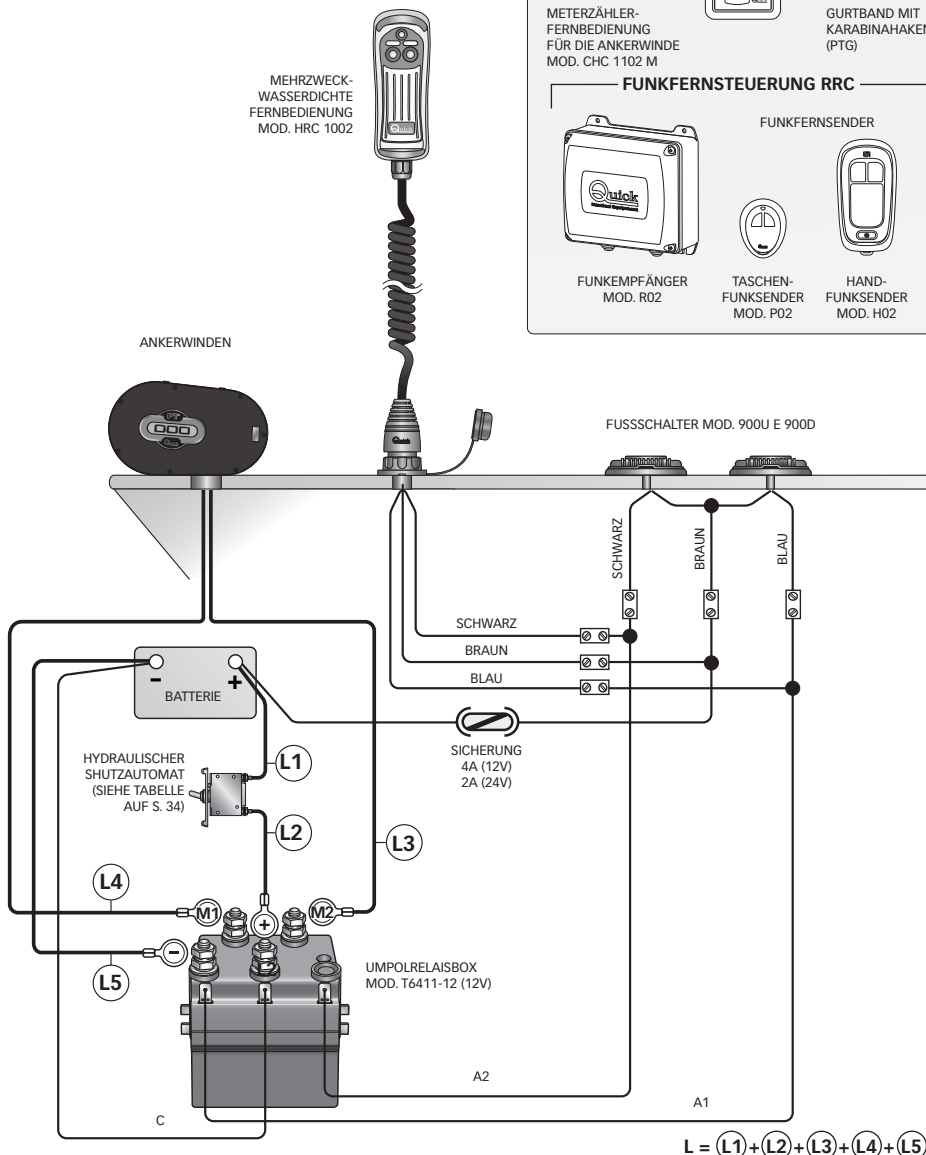
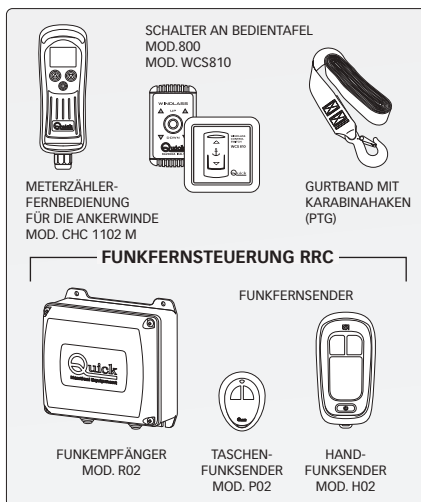

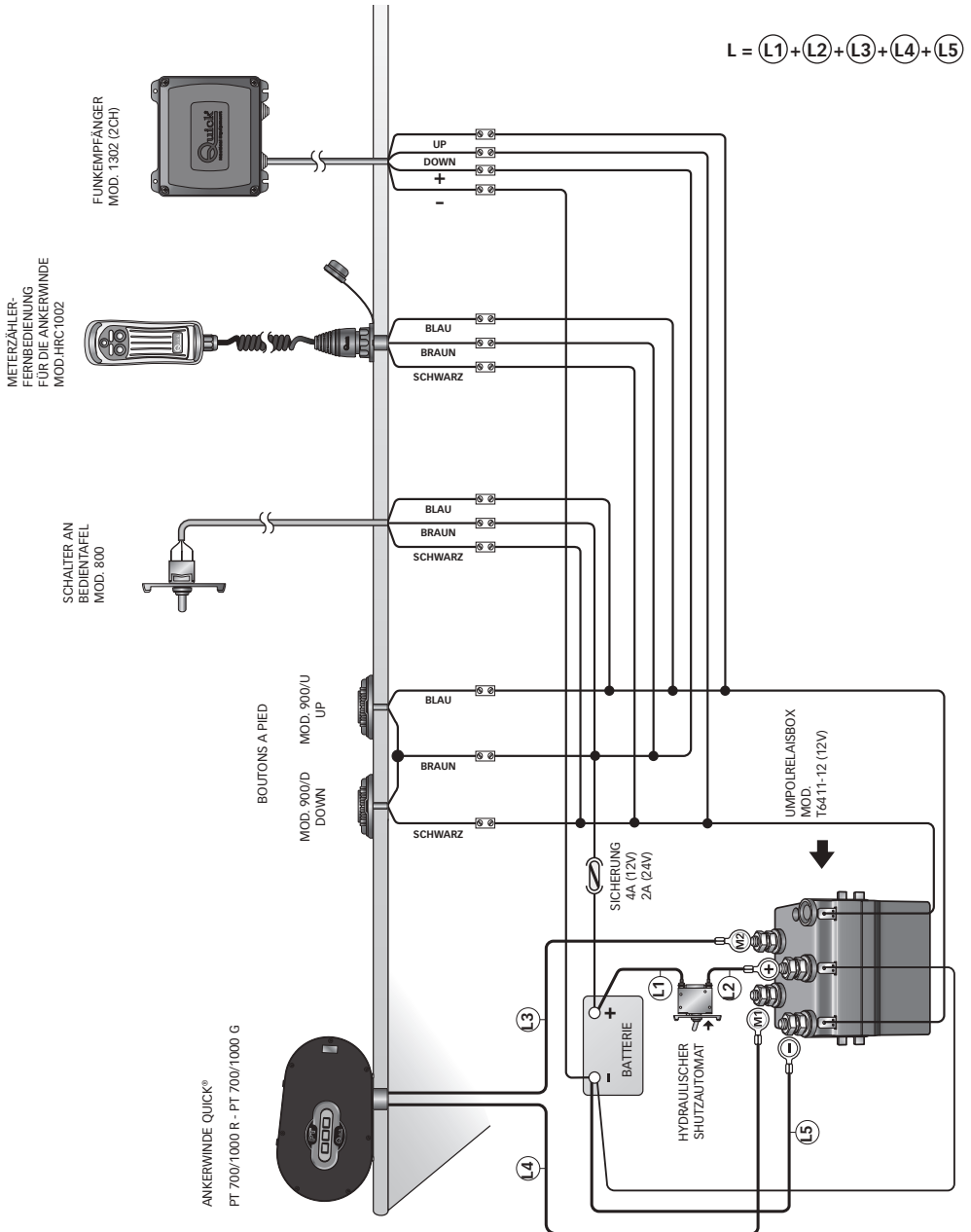

$$L = (L1) + (L2) + (L3) + (L4) + (L5)$$



**BASISSYSTEM
MIT EMPFOHLENE QUICK®-ZUBEHÖRTEILE
FÜR DIE BETÄTIGUNG DER ANKERWINDE**

PT 700 R (mit Bow-roller)

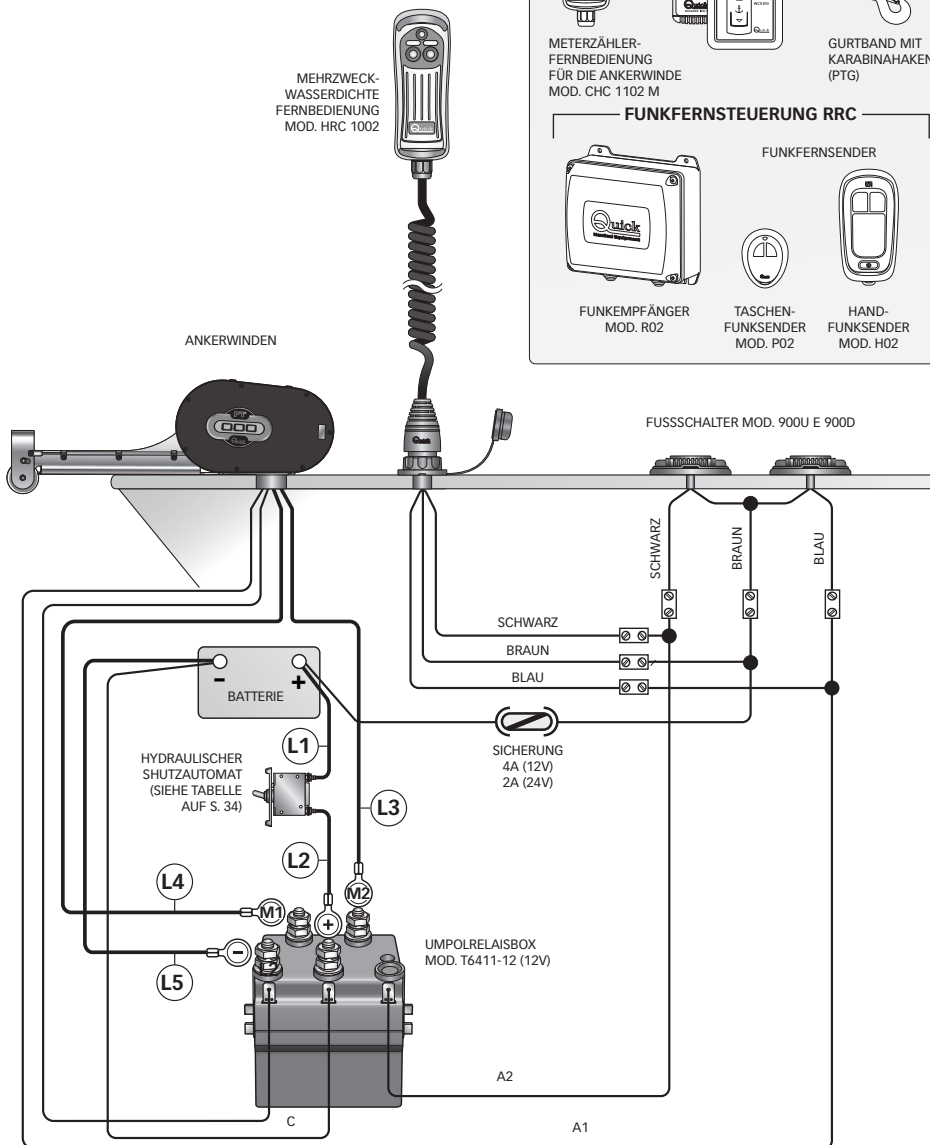

$L = (L1) + (L2) + (L3) + (L4) + (L5)$

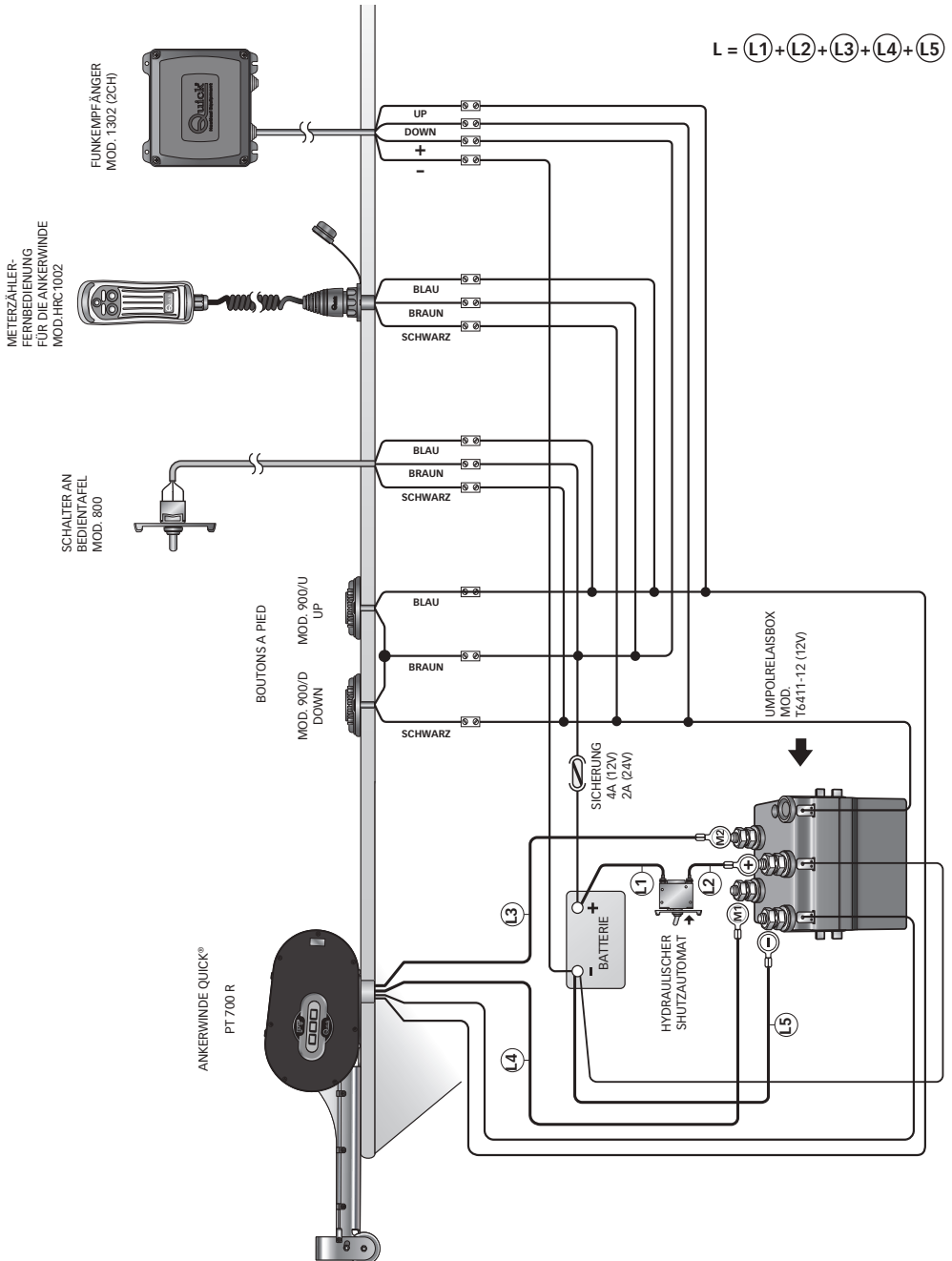



PONTOON 350 -700-1000

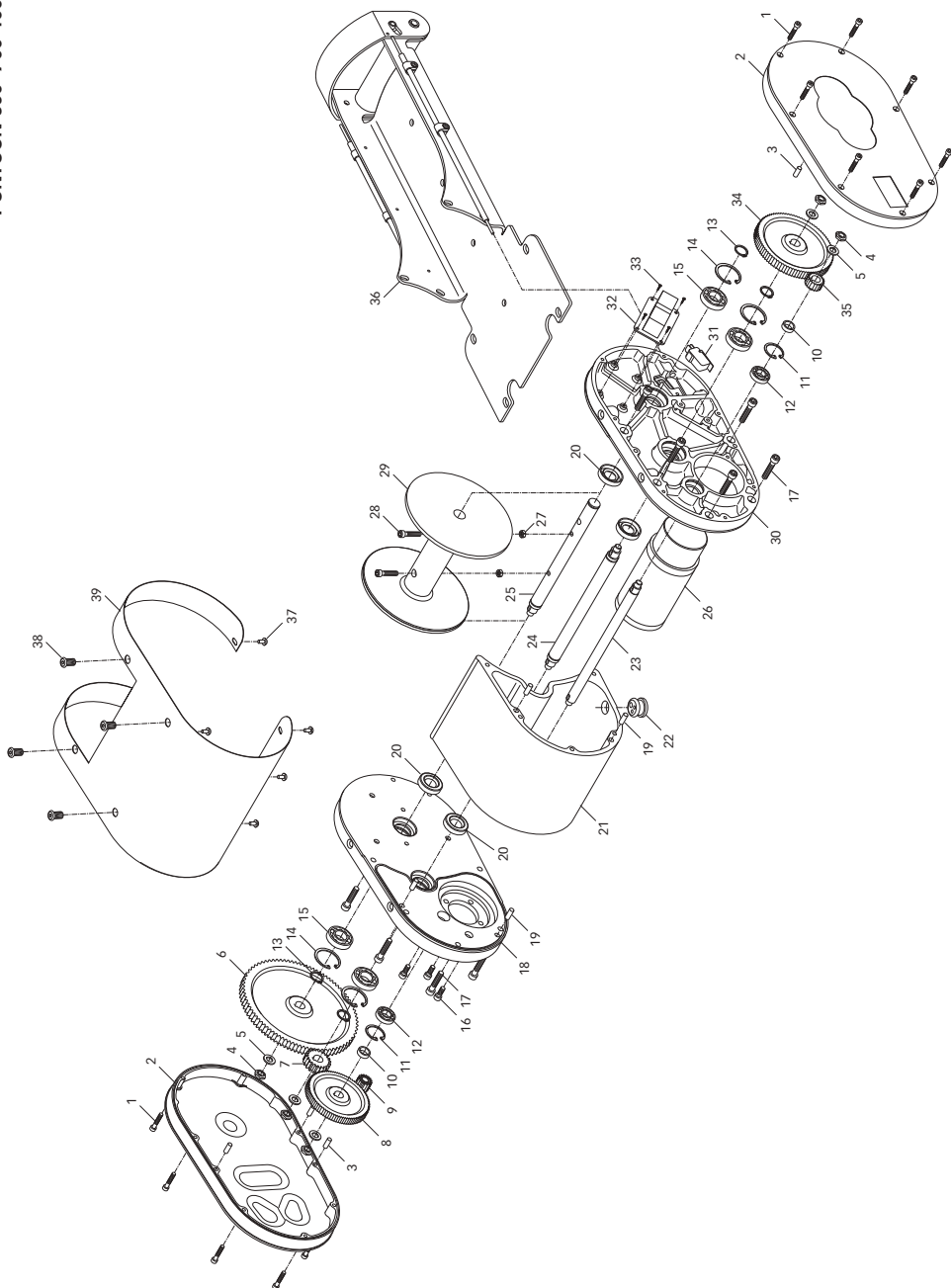



POS.	BEZEICHNUNG
1	SCHRAUB
2	MOTORGEHÄUSE SERIE "PT PLAST"
3	STECKER
4	MUTTERN
5	PASSSCHEIB
6	RAD Z100 M1.5
7	RAD Z20 M1.5
8	RAD Z80 M1
9	RAD Z16 M1
10	DISTANZSTÜCK PT
11	SPRENGRING
12	LAGER
13	SPRENGRING
14	SPRENGRING
15	LAGER
16	SCHRAUB
17	SCHRAUB
18	BASISTEIL ANKERWINDE SERIE PT
19	STECKER
20	ÖLABDICHTUNG
21	EXTRUDIERTER ANKERWINDE SERIE PT
22	KABELDURCHFÜHRUNGEN PT
23	WELLE SERIE PT 1
24	WELLE SERIE PT 2
25	WELLE SERIE PT 3
26A	ELEKTROMOTOR 150W 12V PT
26B	ELEKTROMOTOR 250W 12V PT
26C	ELEKTROMOTOR 350W 24V PT
27	MUTTERN
28	SCHRAUB
29	SPULE SERIE "PT PLAST"
30	BASISTEIL ANKERWINDE SERIE PT
31	TASTE MIKROSCHALTER 16A/250W
32	KARTE UMPOLRELAIS 45A
33	SCHRAUB
34	RAD Z100 M1
35	RAD Z20 M1
36	BOW ROLLER PT KOMPLETT EDELSTAHL
37	SCHRAUB
38	SCHRAUB
39	COVER BASIS SERIE PT EDELSTAHL



ACHTUNG: sicherstellen, daß der elektrische Motor nicht an Spannung liegt, wenn man manuell an der Ankerwinde eingreift. Vorsichtig das Tau von der Spule entfernen.

Die Quick®-Ankerwinden werden aus seewasserfestem Material hergestellt. Dennoch muß man regelmäßige Salzablagerung an den Außenflächen entfernen, um Korrosion und folglich Schäden am Gerät zu vermeiden.

Sorgfältig mit Süßwasser die Oberflächen und die Teile, an denen sich Salz ablagern kann, waschen.



MODELOS PONTOON	PT 350 R - PT 350 G	PT 700 R - PT 700 G	PT 1000 R - PT 1000 G
POTENCIA MOTOR	150 W	250 W	350 W
TENSIÓN ALIMENTACIÓN MOTOR	12 V	12 V	24 V
Tiro instantáneo máximo	260 kg (573,2 lb)	600 kg (1322,7 lb)	750 kg (1653,4 lb)
Carga máxima de trabajo	100 kg (220,4 lb)	220 kg (485,0 lb)	250 kg (551,0 lb)
Carga de trabajo	40 kg (88,1 lb)	80 kg (176,3 lb)	100 kg (220,4 lb)
Absorción de corriente a la carga de trabajo (1)	13 A	22 A	16 A
Velocidad máxima de recuperación (2)	20,8 m/min (68,2 ft/min)	20,8 m/min (68,2 ft/min)	21,5 m/min (70,5 ft/min)
Velocidad de recuperación a la carga de trabajo (2)	19,3 m/min (63,3 ft/min)	18,1 m/min (59,3 ft/min)	18,3 m/min (60,0 ft/min)
Sección mínima cables motor (3)	10 mm ² (AWG7)		
Interruptor de protección (4)	20 A	30 A	20 A
Espesor de cubierta (5)	20 ÷ 40 mm (3/4" ÷ 1" 9/16 ft)		
Peso	10 kg - 22 lb	10,2 kg - 22,4 lb	10,2 kg - 22,4 lb

(1) Después de un primer periodo de utilización.

(2) Medidas efectuadas con cabo de 8 mm.

(3) Valor mínimo aconsejado para una longitud total L<20m (ver esquemas de montaje). Calcular la sección del cable en función de la longitud de la conexión.

(4) Con interruptor específico para corrientes continuas (DC) y retraso (magneto-térmico o magneto-hidráulico).

(5) Bajo petición se pueden suministrar ejes y prisioneros para espesores de cubierta mayores.

DIMENSIONES DE LOS MODELOS mm (inch)

PT 350 R - PT 700 R - PT 1000 R

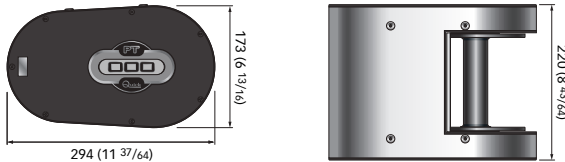

PTR CON ACCESORIO BOW-ROLLER (SÓLO EN LOS MODELOS 350 - 1000)

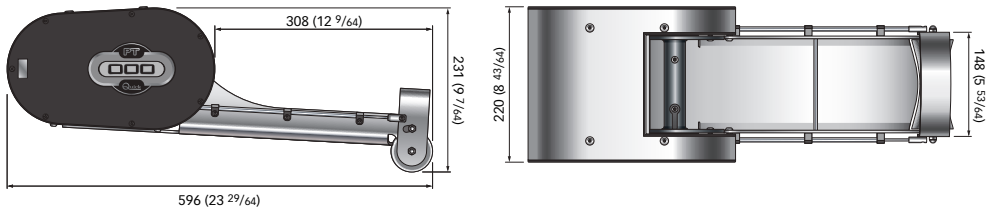

PT 350 G - PT 700 G - PT 1000 G

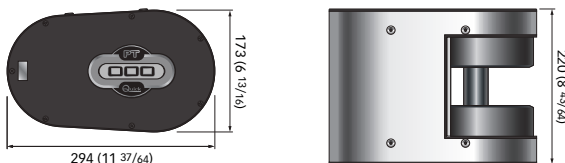

Quick® se reserva el derecho de aportar modificaciones en las características técnicas del aparato y en el contenido de este manual sin obligación de avisar previamente. En caso de discordancias o eventuales errores entre el texto traducido y el texto original en italiano, remitirse al texto en italiano o en inglés.



ANTES DE UTILIZAR EL MOLINETE LEER CON ATENCIÓN EL PRESENTE MANUAL DE INSTRUCCIONES. EN CASO DE DUDA CONSULTAR CON EL CONCESIONARIO VENDEDOR QUICK®.



ATENCIÓN • Los molinetes Quick® han sido proyectados y realizados para llevar las anclas.

- No utilizar estos aparatos para otros tipos de operaciones. • Quick® no asume ningún tipo de responsabilidad por daños directos o indirectos causados por una utilización inadecuada del aparato.
- El molinete no ha sido diseñado para soportar cargas generadas en condiciones atmosféricas especiales (borrasca).
- Desactivar siempre el molinete cuando no se use. • Asegurarse de que no hayan personas bañándose cerca antes de soltar el ancla. • Para más seguridad, si un accionamiento se daña, aconsejamos instalar al menos dos accionamientos para el manejo del molinete. • Aconsejamos el uso del interruptor magneto-hidráulico Quick® como seguridad para el motor. • La caja de teleinvertidores debe instalarse en un lugar protegido de posibles entradas de agua.
- Después de haber anclado la embarcación, fijar la cadena o el cabo a los puntos fijos como chain stopper o bolardo.
- Para evitar deslizamientos involuntarios el ancla tiene que ser fijada; el molinete no se tiene que usar como la única fuente de fuerza. • Aislar el molinete de la planta eléctrica durante la navegación (desconectar el interruptor de protección del motor) y bloquear la cadena en un punto fijo de la embarcación.

LA REFERENCIA CONTIENE: molinete PTG o PTR - caja teleinvertidores (sólo mod. 700/1000) - 30 m de cabos Dyneema (solo PTR) - plantilla - tornillos (para el ensamblaje) - manual del usuario - condiciones de garantía.

HERRAMIENTAS NECESARIAS PARA LA INSTALACIÓN: taladro con brocas: Ø 9 mm (23/64"), Ø 15 mm (63/64"); llave hexagonal: 13 mm.

ACCESORIOS ACONSEJADOS POR QUICK®: mando de panel (mod. 800 - WCS 810) - Tablero de pulsadores hermético (mod. HRC1002) - Mando de pie (mod. 900) - cinta con mosquetón (sólo PTG) - Sistema de accionamiento vía radio RRC (mod. R02, P02, H02).

REQUISITOS PARA LA INSTALACIÓN PTG

Il salpa ancora va posizionato allineando la fettuccia (quindi il centro del salpa) con il gancio del tender da sollevare. Verificare che las superficies superior e inferior de la cubierta sean lo más paralelas posibles; si eso no sucede compensar oportunamente la diferencia (la mancanza di parallelismo potrebbe causare un montaggio non sicuro). El espesor de la cubierta tendrá que ser comprendido entre los valores indicados en el tablero. Si hay espesores diferentes es necesario consultar el revendedor Quick®.

REQUISITOS PARA LA INSTALACIÓN PTR

Il salpa ancora va posizionato allineando il rocchetto con il bow roller. Se il bow roller e' gia montato, assicura curarsi che sporga dalla prua (o dalla poppa) affinché la discesa e la risalita della'ancora nel bow roller non incontri ostacoli. Verificare que las superficies superior e inferior de la cubierta sean lo más paralelas posibles; si eso no sucede compensar oportunamente la diferencia (la mancanza di parallelismo potrebbe causare un montaggio non sicuro). El espesor de la cubierta tendrá que ser comprendido entre los valores indicados en el tablero. Si hay espesores diferentes es necesario consultar el revendedor Quick®.

INSTALACIÓN

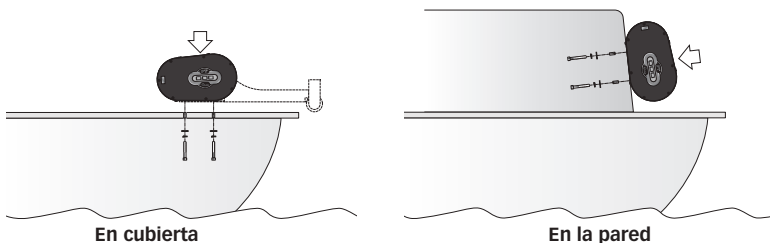

PROCEDIMIENTO DE MONTAJE

Establecida la posición ideal (en cubierta o en la pared) hacer los agujeros utilizando la plantilla que tiene en dotación. Remover el exceso de material del agujero donde pasa la cadena, alisarlo con un producto específico (pintura marina, gel o resina epoxídica). Coloque el elevador de ancla teniendo precaución con los cables de potencia y de mando. Atornille los pernos prisioneros al molinete. Fijar el molinete apretando las tuercas en los prisioneros de bloqueo. Conectar los cables de alimentación que proceden del molinete al teleinvertidores (o a la batería en caso de que el teleinversor esté integrado).



ATENCIÓN: antes de efectuar la conexión asegurarse de que no esté presente la alimentación en los cables.



**SISTEMA BASE
CON ACCESORIOS QUICK® ACONSEJADOS
PARA EL ACCIONAMIENTO DEL MOLINETE**

PT 350 R (versión con o sin Bow-roller)

PT 350 G

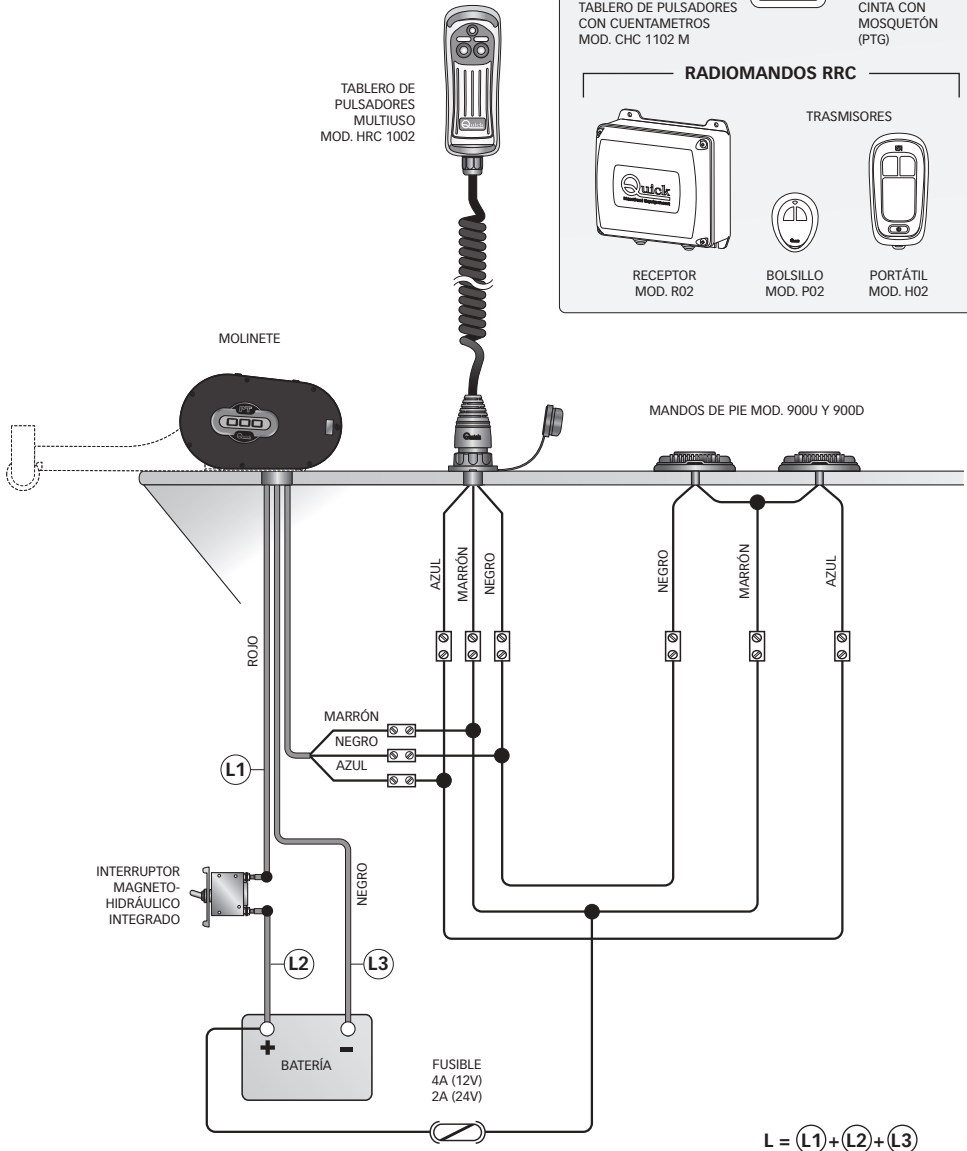

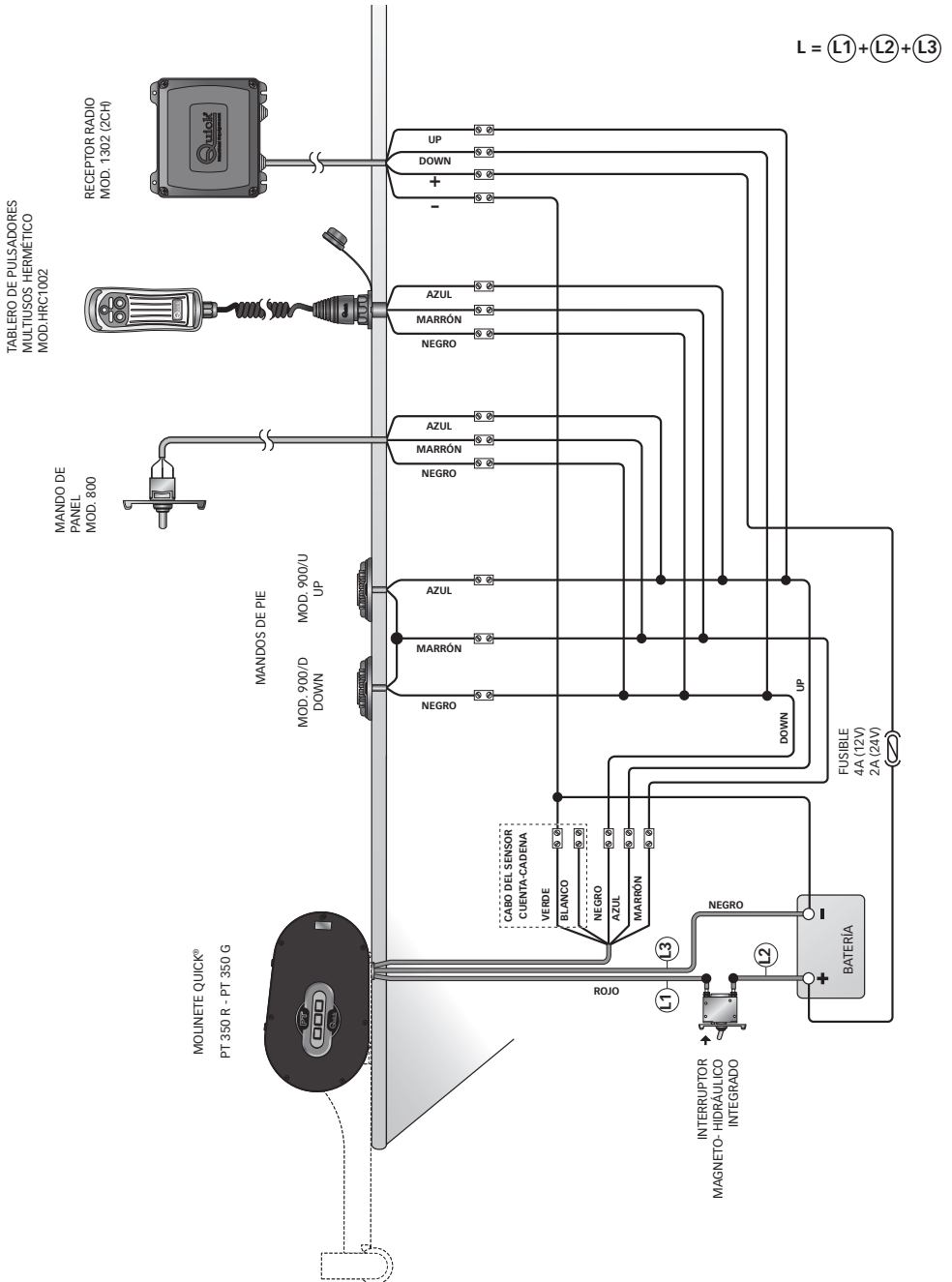



**SISTEMA BASE
CON ACCESORIOS QUICK® ACONSEJADOS
PARA EL ACCIONAMIENTO DEL MOLINETE**

PT 700 R - PT 1000 R

PT 700 G - PT 1000 G

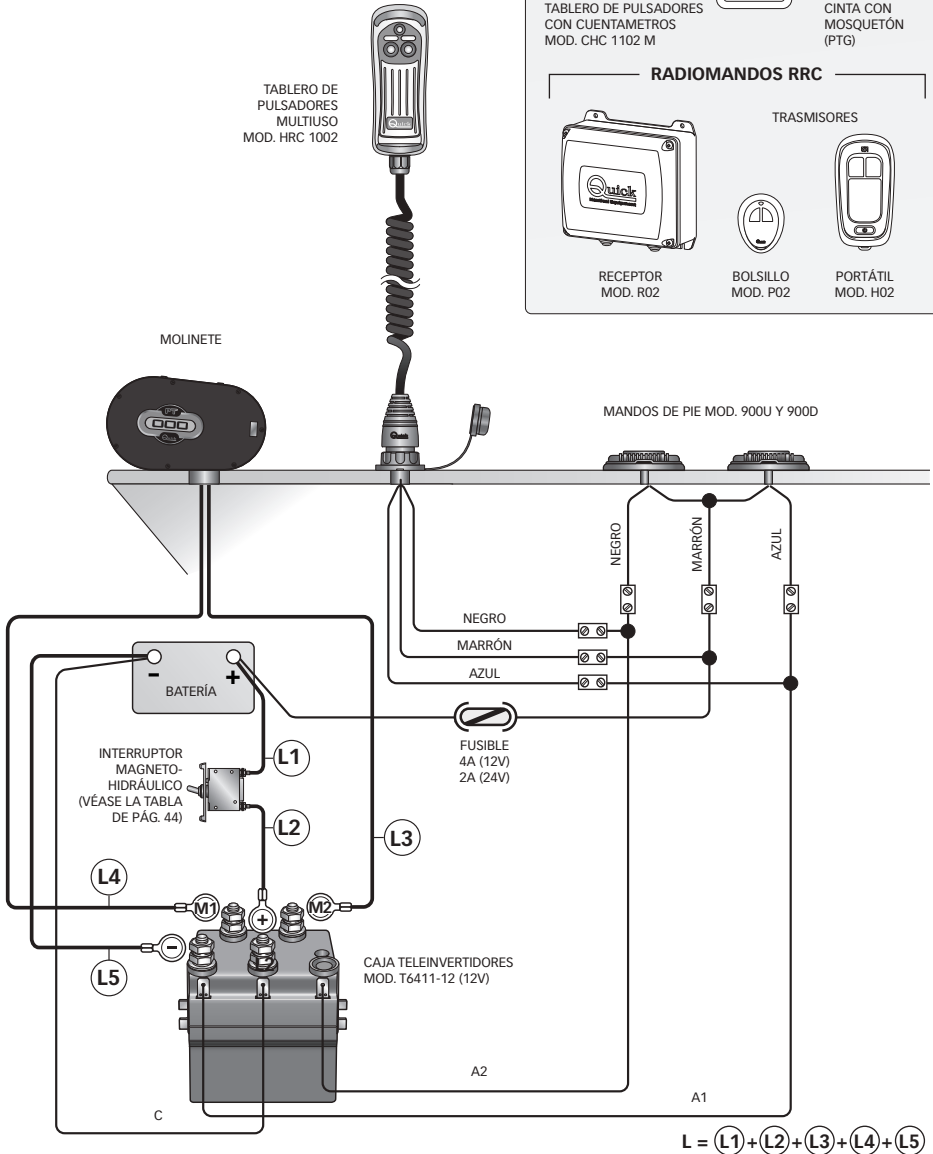

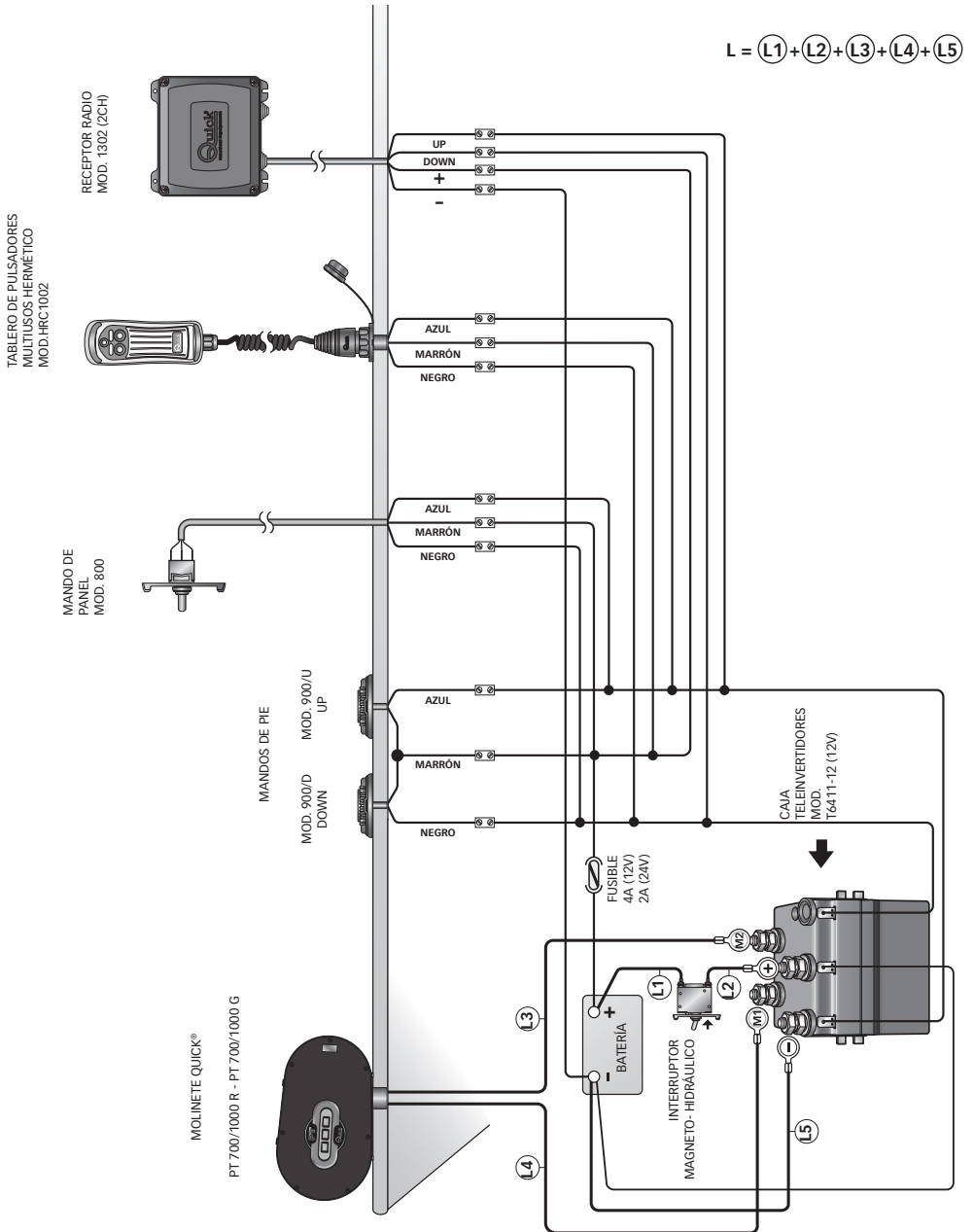



**SISTEMA BASE
CON ACCESORIOS QUICK® ACONSEJADOS
PARA EL ACCIONAMIENTO DEL MOLINETE**

PT 700 R con Bow-Roller

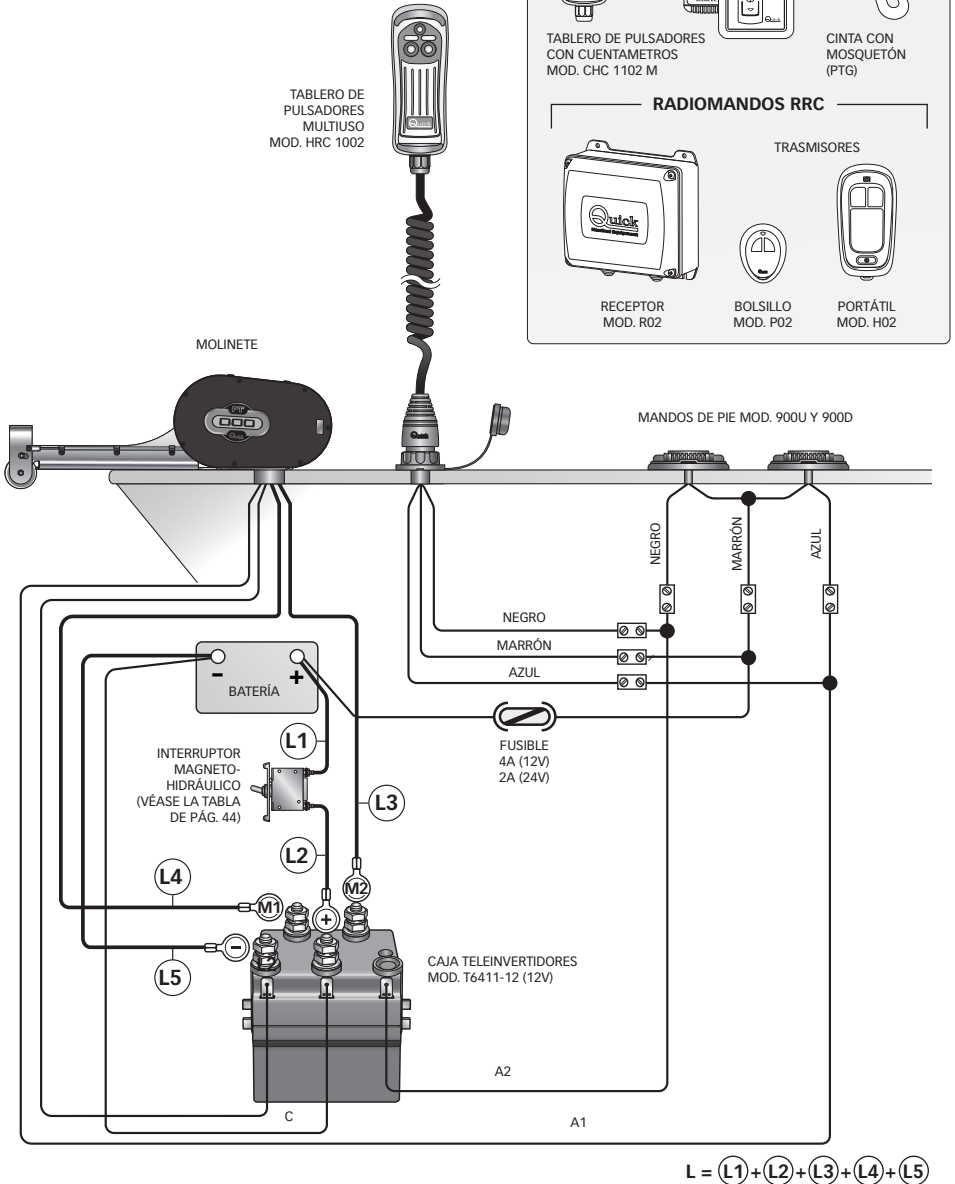

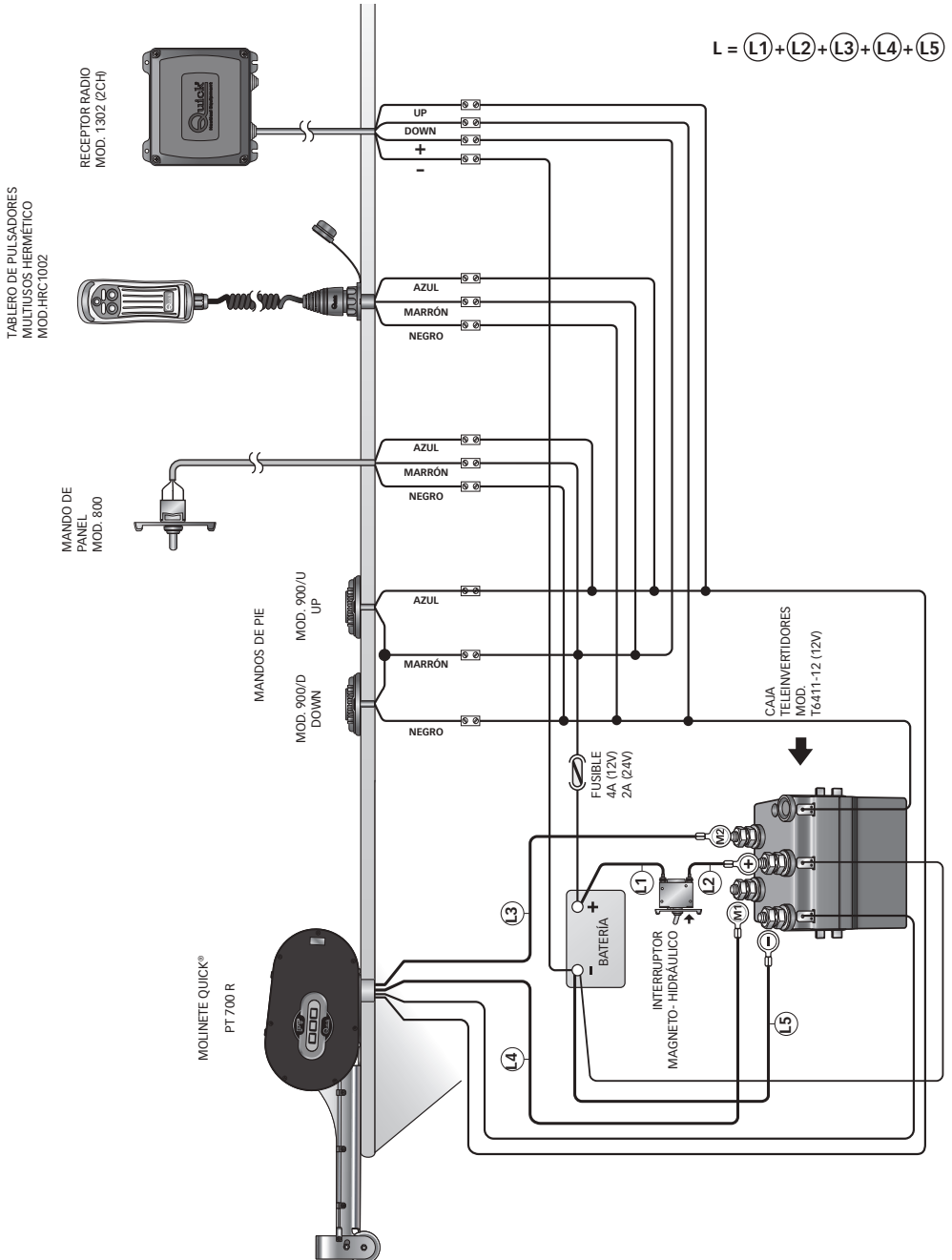



PONTOON 350 -700-1000

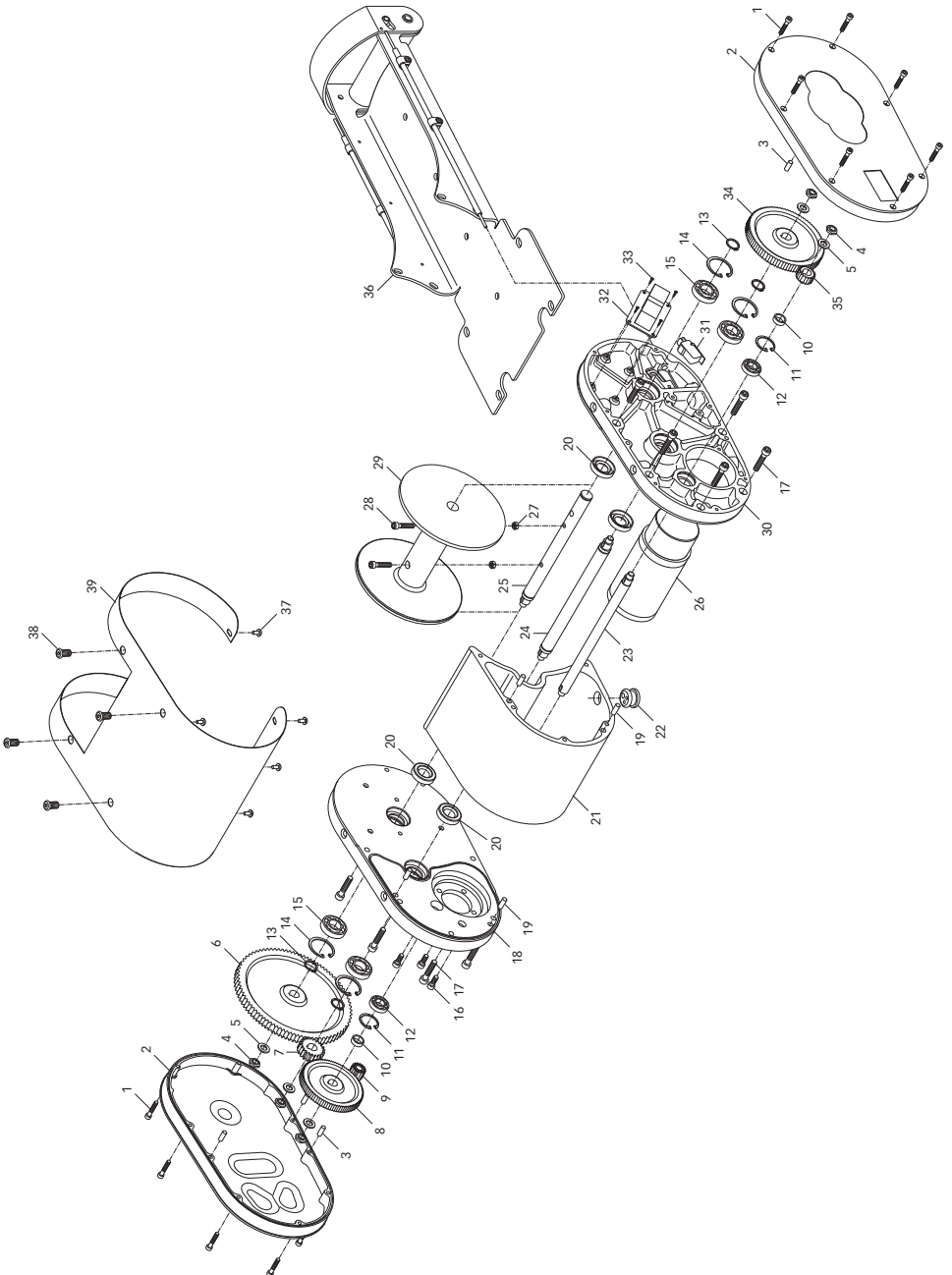



POS.	DENOMINACIÓN
1	TORNILLO
2	CARCASA MOLINETE SERIE "PT PLAST"
3	CLAVIJA
4	TUERCA
5	ARANDELA
6	RUEDA Z100 M1.5
7	RUEDA Z20 M1.5
8	RUEDA Z80 M1
9	RUEDA Z16 M1
10	ESPACIADOR PT
11	SEEGER INTERNO
12	COJIMETE
13	SEEGER EXTERNO
14	SEEGER INTERNO
15	COJINETE
16	TORNILLO
17	TORNILLO
18	BASE MOLINETE SERIE PT
19	CLAVIJA
20	SELLO DE ACEITE
21	EXTRUIDO MOLINETE SERIE PT
22	PASACABLE PT
23	EJE SERIE PT 1
24	EJE SERIE PT 2
25	EJE SERIE PT 3
26A	MOTOR MOLINETE 150W 12V PT
26B	MOTOR MOLINETE 250W 12V PT
26C	MOTOR MOLINETE 350W 24V PT
27	TUERCA
28	TORNILLO
29	CUIDADO SERIE "PT PLAST"
30	BASE MOLINETE SERIE PT
31	BOTÓN MICROINTERRUPTOR 16A/250W
32	TARJETA TELENIV RELE 45A
33	TORNILLO
34	RUEDA Z100 M1
35	RUEDA Z20 M1
36	BOW ROLLER PT COMPLETO INOX
37	TORNILLO
38	TORNILLO
39	TAPA BASE SERIE PT INOX



ATENCIÓN: asegurarse de que no esté presente la alimentación en el motor eléctrico cuando se actúa manualmente en el molinete; quite el cabo de la bobina con cuidado.

Los molinetes Quick® están contruidos con materiales resistentes al ambiente marino; de todas formas, es indispensable eliminar periódicamente los depósitos de sal que se forman sobre las superficies externas para evitar oxidaciones que consiguientemente estropearían el aparato.

Lavar con agua dulce las superficies y aquellas partes donde podría haberse depositado la sal.

NOTES



PONTOON

PT350 - PT700 - PT1000

R003A

IT Codice e numero seriale del prodotto

EN Product code and serial number

FR Code et numéro de série du produit

DE Code- und Seriennummer des Produkts

ES Código y número de serie del producto

 **QUICK**[®] SPA

QUICK[®] S.p.A. - Via Piangipane, 120/A - 48124 Piangipane (RA) - ITALY
Tel. +39.0544.415061 - Fax +39.0544.415047

www.quickitaly.com