

T4.270

SPECIFICATIONS

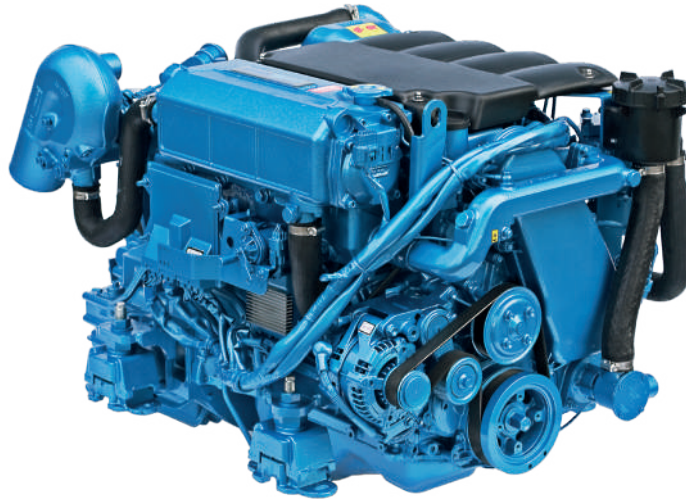

Power at crankshaft	194.9 kW [265 hp]	Engine base	Toyota
Displacement	2.982 l [182 in³]	Fuel system	Direct injection High pressure Common Rail Electronically controlled
Configuration	4 cylinders in line	Air intake	Turbocharged with intercooler
Operation type	4 strokes Diesel	Cooling	Closed cooling with heat exchanger
Bore & Stroke	96 x 103 mm [3.78 x 4.06 in]	Max mounting angle	7° Front down 7° Front up
Compression ratio	15 : 1	Alternator	12 Volt 130 Amp
Rated speed	3600 rpm	Rating	M6
Idling speed	700 rpm	Emission compliance	IMO Annex VI Compliant RCD 2013/53/EU EPA marine Tier 3 BSO2
Peak torque	660 Nm	Dry weight with TTM50A	393 kg [866 lbs]
Peak torque speed	2000 rpm		

T4.270

194.9 kW [265 hp] at 3600 rpm

TECHNICAL DESCRIPTION

ENGINE BLOCK

- 4 cylinders in line
- 4 valves per cylinder
- Dual overhead camshaft (DOHC)
- Watercooled exhaust manifold
- Internal balancers

FUEL SYSTEM

- Common Rail injection system
- Fuel filter with hand primer
- Integrated fuel cooler

LUBRICATION SYSTEM

- Replacable full-flow oil filter
- Oil dipstick
- Transmission oil cooler

COOLING SYSTEM

- Closed cooling with heat exchanger
- Gear driven self-priming raw water pump
- Coolant circulating pump
- Water cooled exhaust elbow

ELECTRICAL SYSTEM & INSTRUMENTATION

- 12 V / 100 A alternator
- 12 V Electrical system
- Complete instrumentation including key switch and alarms
- Extension cable harness with plug-in connection

AIR INTAKE

- Dry turbocharger
- Intercooler

OTHER FEATURES

- Flexible engine mountings

OPTIONAL EQUIPMENTS & ACCESSORIES

- Complete marine propulsion systems
- Marine transmission adaptation kits
- Throttle and shift controls
- Additional instrumentation, Flying bridge extension harness
- Water boiler systems
- Complete fuel systems
- Complete exhaust systems
- Trolling valve

RATINGS

- Up to 500 annual operating hours
- Load factor up to 35%
- Full power for no more than 30 minutes out of each 8 hours of operation. The remaining time must be at, or below cruising speed

TRANSMISSIONS

SHAFT LINE

- TTM40A
- TTM50A
- ZF63A

STERN DRIVE

- Bravo X One
- Bravo X Three
- Bravo X Two
- Contact your local Nanni dealer for more details and availability for transmission model and type.

PERFORMANCE CURVES

POWER AT CRANKSHAFT

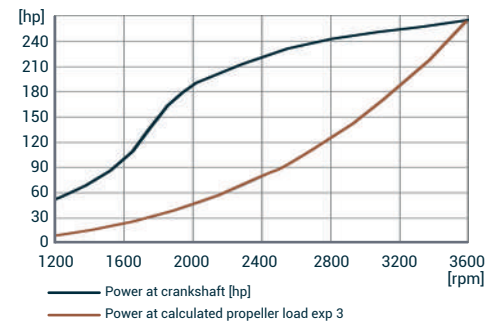

TORQUE AT CRANKSHAFT

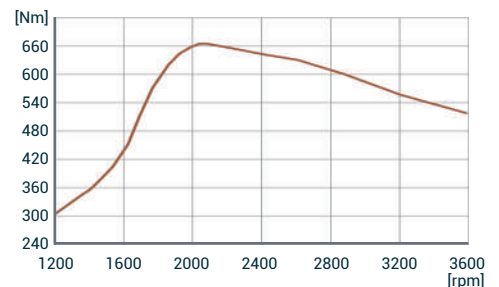

FUEL CONSUMPTION

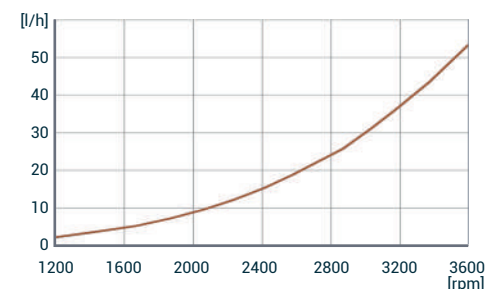

DIMENSIONS WITH TTM50A

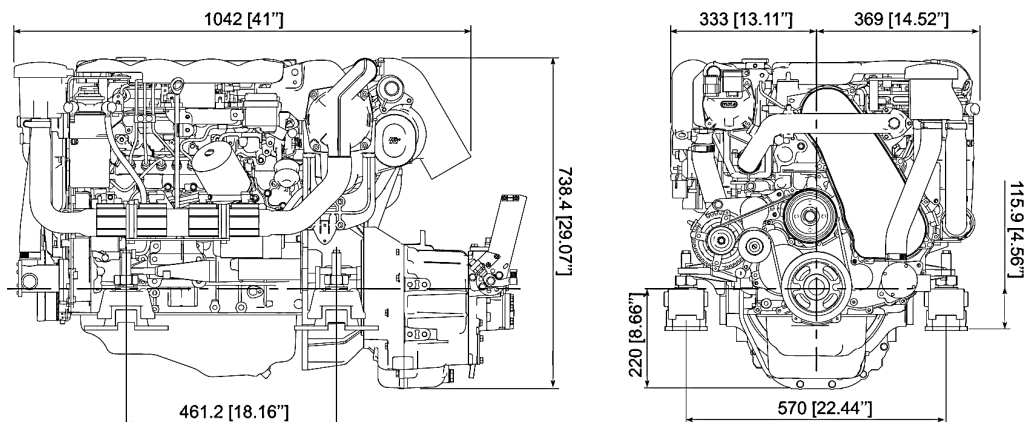

NANNI INDUSTRIES S.A.S.

11, Avenue Mariotte - Zone Industrielle
33260 La Teste - France
Tel: +33 (0)5 56 22 30 60
Fax: +33 (0)5 56 22 30 79

Technical data according to ISO 8665. This document is not contractual. Nanni reserves the right to modify any of the characteristics stated in this document without notice, in a constant effort to improve the quality of its products. Images and illustrations may show non standard equipments. All combination of equipment & accessory are not available.

DGBXXC01014